

**KATARZYNA KLEMM¹, KRZYSZTOF PIESZYŃSKI²
KAZIMIERZ ROŹNIAKOWSKI²**

¹Institute of Architecture and Urban Planning, Technical University of Łódź
Al. Politechniki 6, 90-924 Łódź, Poland, e-mail: katarzyna.klemm@p.lodz.pl

²Institute of Physics, Technical University of Łódź, ul. Wólczańska 219
90-924 Łódź, Poland, e-mail: krzysztof.pieszynski@p.lodz.pl

PROPAGATION OF LASER BEAM IN AIR STREAM COLLIDING WITH NON STREAMLINED OBSTACLE

The paper presents measurements of refractive index structure constant C_n in the region of air inflow in vicinity of non streamlined obstacle (a model of a building) placed on a flat surface. Examinations were conducted in aerodynamic tunnel which transverse dimensions were much bigger than the examined model. The applied narrow beam of laser light had elliptical cross-section. Computations of C_n parameter were based on the dancing spot model [1].

Keywords: refractive index structure constant C_n , laser, beam wander, non streamlined obstacle, model of building.

1. INTRODUCTION

The flow of air near buildings and its resulting effects substantially influence the comfort of people in their vicinity. For this reason the conditions of air flow should be taken into account when preparing architectural and town planning projects. Studies on the interaction of wind and buildings belong to the realm of buildings' aerodynamics. The examinations of velocity profiles around non streamlined objects provide the designers of residential and industrial developments with relevant data about the effects of buildings on the direction and magnitude of local winds. Such information is essential to:

- ensure appropriate comfort for inhabitants and passers-by by eliminating regions with sudden blows and vortices of air near buildings and

lessening bothersome aerodynamic noise and draughts related to unfavourable conditions of wind movement,

- eliminate adverse interactions in heating, cooling and ventilating systems such as draughts inside the buildings and additional heat loss which are direct results of flow conditions outside the building, especially near its windows, doors and air conditioning intakes,
- aerodynamic examination of industrial housing models capable of predicting the course of pollutants dispersion and localization of points with highest concentration of these substances.

Air turbulences near non streamlined architectural objects (rectangular buildings) can be recorded with the use of laser beam propagating through the air with local changes of flow, caused by these buildings [2]. One of possibilities of model examinations is to make use of aerodynamic tunnel where air stream of known average velocity is directed onto the scaled model of the building. Analysis of intensity changes of laser beams in different distances from the model can reveal time evolution of ongoing turbulent process [3] [4].

The aim of the conducted research was to experimentally prove the possibility of recording flow perturbations (fluctuations of density) in wind tunnel caused by the model of building, through examinations of refractive index structure constant C_n in this setup.

2. THEORETICAL FOUNDATION

2.1. Flow pattern near rectangular block

Examination of air flow in vicinity of singly standing models or small groups of models with different geometry and orientation relative to the direction of air stream can be helpful in preparing suggestions for better design of more complex, real architectural systems. In such research it is essential to create a velocity profile of flowing air similar in shape to the realistic conditions above the terrain of given topography.

The picture of flow lines around the solid rectangular block with sharp edges protruding from the substrate, sketched in Fig.1 is, according to Hosker [5], very complex.

Three regions characteristic for this type of flow can be clearly discerned: upwind region of horseshoe vortex formation (1), upper flow (2), flow reversal zone (3) and downwind reattachment zone (4). In the process of horseshoe vortex formation two points of separation can be found – primary S and

secondary S_1 . The distance between the point of secondary separation from the object gives the approximate size of the horseshoe vortex while the line going through the point of primary separation outlines the boundary of the region changed by the presence of the object. The boundary of reversal zone is determined by the point where upper flow line becomes tangent to the substrate. The direction of flow along this line is reversed above the substrate. Schematic flow profiles in vertical and horizontal cross-section are shown in Fig. 1.

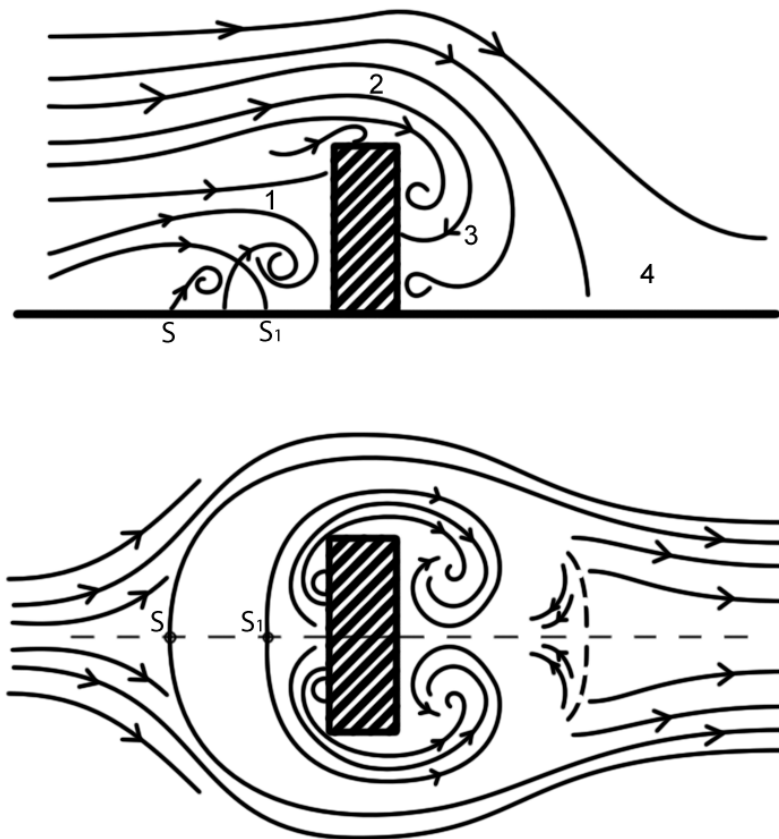

Fig. 1. Wind flow view in vertical and horizontal plane [6]

2.2. Refractive index structure constant C_n

One of the most important parameters which appear in many equations describing the disturbances of laser beam propagation in the medium with density fluctuation is the refractive index structure constant C_n . Its value can be found from the difference of pressure p and temperature T in two points distant by r . When r is measured in centimetres, pressure in milibars and temperature in Kelvins then the parameter C_n is [1]:

$$C_n = \left[79 \times 10^{-6} \frac{p}{T^2} \right] C_T \quad (1)$$

Where temperature structure constant C_T is:

$$C_T = \sqrt{\langle (T_1 - T_2)^2 \rangle} r^{-1/3} \quad (2)$$

2.3. Beam wander

The direction of laser beam propagation is subject to changes caused by time and space dependent gradients of refractive index. These gradients arise from changes of air velocity, density, pressure or temperature. As a final result the displacement of laser spot is observed on a screen placed normally to the beam.

This phenomenon, known in the literature as „beam wander” and connected with turbulences across big regions can be treated with methods of geometrical optics and its analytic description was presented by Chiba [1]. The expression for radial variance of the beam with radius w derived by Chiba is:

$$\sigma_r^2 = 1.90 C_n^2 (2w)^{-1/3} L^3 \quad (3)$$

For Gaussian beam of He-Ne laser ($\lambda = 0.633\mu\text{m}$) standard deviation of beam wandering along X axis on the screen distant from the laser by L can be written as:

$$\sigma_x = 3.14 C_n L^{17/12} \quad (4)$$

This formula shows that the mean standard deviation of the beam spot position is a function of parameter C_n .

Consequently if there is technical possibility of recording changes of laser spot position in time then formula (4) can be used to determine parameter C_n .

In the presented work it was assumed that standard deviations of the laser spot for directions X and Y are the same.

3. EXPERIMENT

3.1. Wind tunnel

Propagation of laser beam across the stream of air flowing towards the model of a building (cube with the edge length 0,10 m) was examined in the wind tunnel of cross-sectional dimensions 1x1 m and 5 meters long (Fig. 2).

The tunnel's walls were made from transparent PMMA plates 15 mm thick. Four fans placed in one housing perpendicular to the tunnel's axis generated forced flow of air. Flow velocity was changed between 0.5 m/s and 3 m/s.

3.2. Velocity measurements

Velocity of air flow was recorded with the use of thermo-anemometer placed in the front plane of the object at the height $z = 0.06$ m. Uncertainty of velocity measurements was 0.1 m/s.

Examinations were conducted for four different velocities, $V_0 = 0.5; 1.3; 2.2; 3.0$ m/s. The model was placed 2 m from the rear end of the tunnel.

3.3. Laser

A diode laser of power $P = 14$ mW and a wavelength $\lambda = 635$ nm was used as a source of light probing the air flow. Special optical system was applied to make the light beam practically parallel when crossing the wind tunnel. This system also determined elliptical cross-section of the beam (axes lengths: $R_1 = 3$ mm, $R_2 = 1$ mm). The longer axis was positioned vertically. The displacement of the beam along the distance of $0.5 \cdot 10^{-6}$ m generated photodetector's voltage of 1 mV. The dependence was linear within 2 V interval [3].

3.4. Detection of the signal

Measurements of laser light intensity were realized with photodiode BPYP17 connected to a battery. The diaphragm of diameter 0.1 mm was placed in front of the photodiode and its position relative to the laser spot was suitably adjusted to obtain linear dependence between produced voltage and the displacement of the spot. The laser and the photodiode were fixed to one frame which had no mechanical contact with the wind tunnel. The laser beam crossed the wind tunnel perpendicularly to its axis through two holes of 10 mm diameter bored in the side walls. The sampling rate of laser light intensity was 2 kHz and one measurement lasted 35 seconds. Both the laser and the photodiode were as close as possible to the tunnel (without touching it) so it can be assumed that the beam of light propagated only inside the tunnel. Figure 2 presents the diagram of the experimental setup.

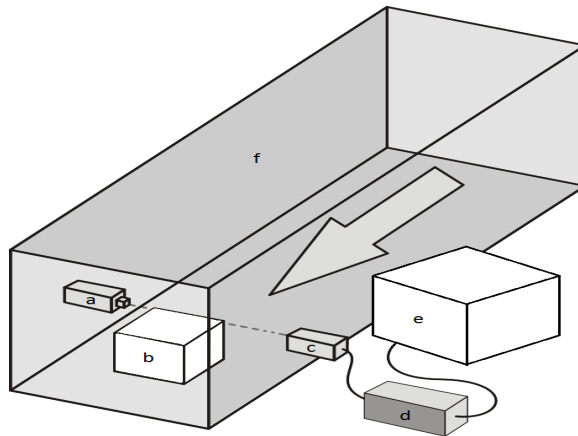

Fig. 2. The diagram of the experimental setup: a – laser, b – building model as a cube, c – photodetector with the optical system, d – analog-to-digital converter, e – computer, f – wind tunnel. All elements in this figure are exaggerated for the clarity of the diagram. The large arrow in the tunnel indicates the direction of air flow in the wind tunnel

3.5. Procedure of the measurements

Fifteen series of measurements were conducted and each series included the following:

- a) registration of light intensity (its fluctuations) for 35 seconds with no flow in tunnel,

- b) registration of light intensity fluctuations for 35 seconds for forced flow of air with chosen velocities (point 3.2) in the empty tunnel,
 c) registration of light intensity fluctuations for 35 seconds with velocities of forced flow as in b) and for the distance of the probing light beam from the upwind wall of the model (placed in the tunnel) equal to: 0.5; 1.0; 1.5; 2.0; 2.5; 3.0; 3.5; 4.0; 4.5; 5.0; 6.0; 7.0; 8.0; 9.0; 10.0 cm.

4. RESULTS OF THE EXPERIMENT

The obtained results are presented in Figs. 3-8 and Tabs. 1 and 2.

Fig. 3 shows characteristic fluctuations of light intensity during 35 seconds of the measurement (the sampling rate 2 kHz) without the model (the empty tunnel): first in still air (upper left picture) and then for increasing velocities of forced flow. It is clearly seen that the amplitude of light intensity fluctuations (resulting from random displacements of the laser light spot) increases with increasing velocity of air in the tunnel.

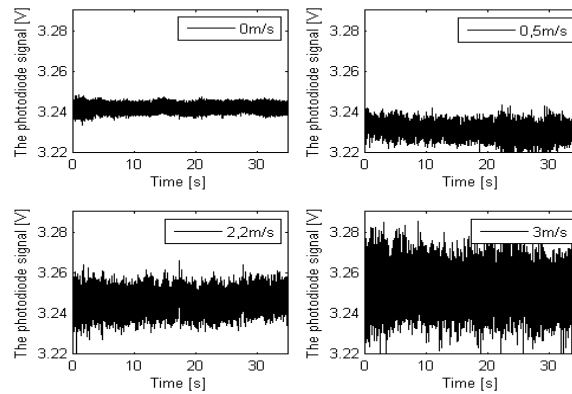

Fig. 3. Fluctuations of light intensity versus time for different velocity of air in the wind tunnel

From these results the mean standard deviation σ_x of the beam spot position was calculated for each of the fifteen measurements and then the refractive index structure constant C_n was found according to formula (3) derived by Chiba [1]. The values of C_n parameter for the measurements from all 15 series, without the

forced air flow and for empty tunnel are presented in Fig. 4. The average value is included in Table 1.

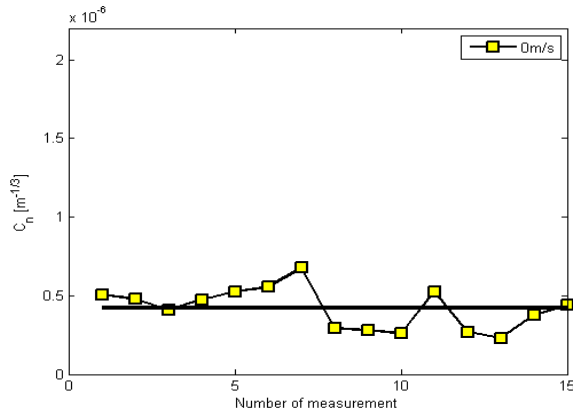

Fig. 4. Refractive index structure parameter C_n versus number of measurement without both forced air flow and the building model in tunnel

Fig. 5 presents the values of C_n parameter for consecutive measurements with the empty tunnel but with the forced air flow of different velocities. The relevant averaged values are included in Table 1 but also marked in Fig. 5 as horizontal lines.

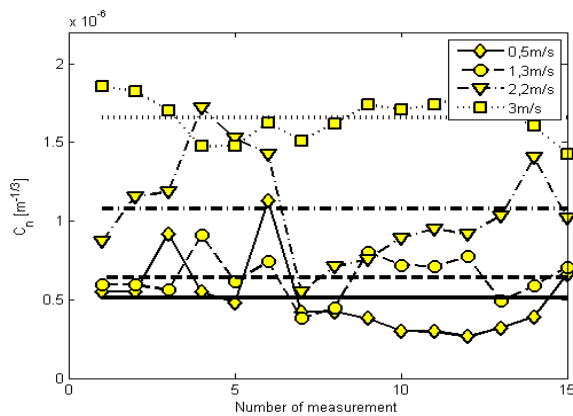

Fig. 5. The C_n parameter versus number of measurement with forced air flow and without the building model in the tunnel. The values of inflowing air velocity in the wind tunnel are specified in the legend

The dependence of the averaged values of the parameter C_n on the air flow velocity is clearly showed in Fig.6. One can easily notice, in the examined range of velocities, the monotonic increase of C_n with growing velocities of incoming air.

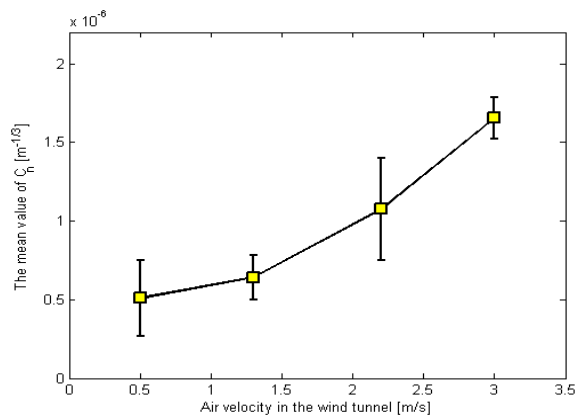

Fig. 6. The mean values of C_n parameter versus air velocity in the wind tunnel (without the building model)

All the measurements and results presented above refer to the laser beam crossing the wind tunnel 6 cm above its base while the transverse dimensions of the tunnel were 1 m x 1 m.

Table 1

The values of inflowing air velocity in the wind tunnel (without building model) and the corresponding C_n parameters

Air velocity	Average value of C_n
[m/s]	[$m^{-1/3}$]
0	$4.20 \cdot 10^{-7}$
0.5	$5.09 \cdot 10^{-7}$
1.3	$6.42 \cdot 10^{-7}$
2.2	$1.07 \cdot 10^{-6}$
3.0	$1.65 \cdot 10^{-6}$

Fig. 7 presents the averaged values of C_n parameter (from 15 measurements) when the building model was placed inside the tunnel, for different distances of the probing light beam from the upwind wall of the model and for different velocities of air flow. These results prove that the parameter C_n depends both on the distance of the probing beam from the model and on velocity of forced air flow.

Next, another kind of averaging was carried out: within two intervals of the distances of the probing beam and the model. One interval was 0-3.5 cm and the second interval included the distances 4.0-10.0 cm. The results of this step are presented in Fig. 7 (horizontal lines) and in Tab. 2. When values of these specific averages are presented versus flow velocity in Fig. 8 – one can notice the monotonic increase of C_n with growing velocities of incoming air. As to this feature Fig. 8 is similar to Fig. 6. The difference between the results for the first and the second intervals is essential except the case of velocity equal to 1.3 m/s.

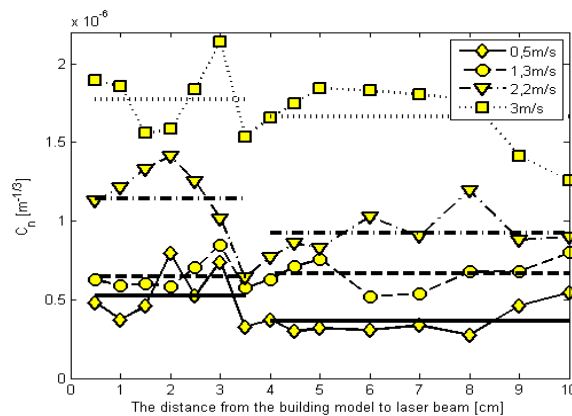

Fig. 7. The C_n parameter versus the distance from the building model to laser beam (the values of inflowing air velocity in the wind tunnel are specified in the legend)

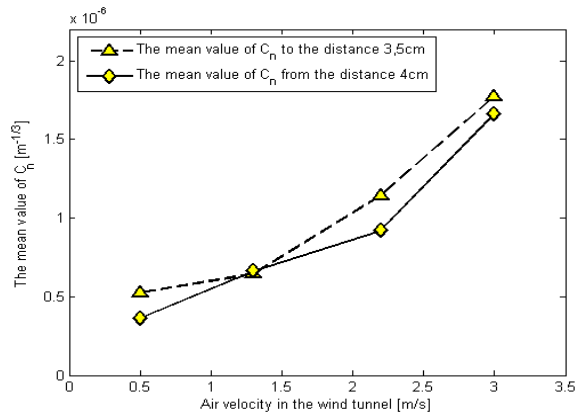

Fig. 8. The C_n parameter mean value dependence on inflowing air velocity in the wind tunnel. The mean values were calculated for two ranges of distances from building model to the laser beam (as described in the legend)

Table 2

The values of inflowing air velocity in the wind tunnel (building model in the wind tunnel) and the corresponding C_n parameters

Air velocity	The mean value of C_n within interval of the distances 0÷3.5 cm of the probing beam and the model	The mean value of C_n within interval of the distances 4÷10 cm of the probing beam and the model
[m/s]	[$m^{-1/3}$]	[$m^{-1/3}$]
0.5	$5.27 \cdot 10^{-7}$	$3.63 \cdot 10^{-7}$
1.3	$6.45 \cdot 10^{-7}$	$6.64 \cdot 10^{-7}$
2.2	$1.14 \cdot 10^{-6}$	$9.20 \cdot 10^{-7}$
3.0	$1.77 \cdot 10^{-6}$	$1.67 \cdot 10^{-6}$

5. DISCUSSION AND CONCLUSIONS

Comparison of the refractive index structure constant C_n for the measurements in the empty tunnel and the tunnel with the model a distinct difference of values is found for the beam to model distance range 0-3.5 cm. Within this range the horseshoe vortex is formed with two basic points of separation (primary and secondary), negative gradient of pressure and the reversal of the flow above the surface.

Such a difference is not observed for the beam to model distance range 4-10 cm. It means that at such distances in front of the obstacle the flow of air is practically undisturbed.

The advantage of the presented method is that the application of the laser beam does not disturb the flow of air, contrary to the detectors used in conventional methods. For this reason it can be especially useful for examinations in front of the obstacle.

Fluctuations of light intensity registered in this work are generated along the path of the laser beam across the tunnel (circa 1m) and so they include averaged information about fluctuations of air velocity, pressure and temperature. So, the applied method differs considerably from classical examinations of flow characteristics.

It should be underlined that despite the presence of effects which were the drawbacks of the system and influenced the obtained results like: small area of the obstacle (only 1% of the tunnel's cross-section), certain features of the construction and foundation of the tunnel as well as the presence of undetermined low temperature sources of heat – there is meaningful change of the C_n parameter caused by the placing of the model. Application of laser beam displacement detector of better sensitivity would significantly improve the precision of the C_n parameter determination.

It can be expected that the application of precise driving mechanism for positioning of the laser beam relative to the model would help in precise location of two points of separation, primary S and secondary S_1 , which occur in the process of horseshoe vortex formation. Moreover, the authors think that the proposed method of their determination is one of the few which does not disturb the flow of air and its chemical composition.

REFERENCES

- [1] **Chiba T.**, Applied Optics, **10** (1971) 2456.
- [2] **Klemm K., Pieszyński K., Roźniakowski K.**, Fizyka Budowli w Teorii i Praktyce, Tom III, 2008, p. 43.
http://www.imc.pcz.czyst.pl/instytut/pl/3/3.8/materialy/eelab/ee_11.pdf
- [3] **Pieszyński K., Roźniakowski K., Wypych W.**, Sci. Bull. Tech. Univ. Lodz, No. 991 Physics **27** (2006) 53.
- [4] **Klemm K., Pieszyński K., Roźniakowski K.**, Optica Applicata, **37** (2007) 219
- [5] **Hosker R.P.**, ASHRAE Transactions **91**, 2B, (1985) 1672.
- [6] **Peterka J.A., Meroney R.N., Kothari K.M.**, Journal of Wind Engineering and Industrial Aerodynamics. **21**, 1985, p. 21.

**PROPAGACJA WIĄZKI ŚWIATŁA LASERA
W STRUDZE POWIETRZA ZDERZAJĄCEJ SIĘ
Z NIEOPŁYWOWĄ PRZESZKODĄ**

Streszczenie

W pracy przedstawiono wyniki pomiarów struktury współczynnika załamania światła C_n w obszarze strumienia powietrza napływającego na nieopływową przeszkodę (model budynku). Badania były przeprowadzone w tunelu aerodynamicznym, którego wymiary w przekroju poprzecznym były znacznie większe niż wymiary modelu. W badaniach zastosowano wąską wiązkę światła lasera o eliptycznym przekroju poprzecznym. Obliczenia parametru C_n przeprowadzono na podstawie modelu tańczącej laserowej plamki.