

Calculation of First-, Second-Order and Multiparameter Symbolic Sensitivity of Active Circuits by Using Nullor Model and Modified Coates Flow Graph

Irina N. Asenova

Abstract—A new method of first-, second-order and multiparameter symbolic sensitivity determination based on the nullor model of active devices and modified Coates flow graph is presented. Rules for a symbolic reduction of nullor circuit complexity are described. An algorithm performs symbolic sensitivity analysis with respect to various circuit parameters appeared not only at one location in the modified Coates flow graph. Advantages of the method suggested are that, the matrix inversion is not required and the main drawback of some methods based on the adjoint graph, i.e. the necessity to analyze the corresponding graph twice, is avoided. Illustrative examples on symbolic sensitivity analysis are given.

Index Terms—analogue circuits, flow graphs, nullor model, symbolic sensitivity analysis.

I. INTRODUCTION

SENSITIVITY analysis plays an important role in determining the critical design variables in analog circuit analysis and synthesis [1], [2]. Sensitivity analysis is used in a wide range of areas such as prediction and evaluation of change in the characteristics of a network due to the change in the parameters, and optimization design of the network [3]. According to the classical formulae, the calculation of the first- and second-order transfer function sensitivities needs in the first place to find the corresponding derivatives. This is the main problem sensitivity analysis and its investigation is an object of some special methods, described in the literature [4], [5]. Coates flow graph (CFG) is useful and often used in the network theory and in the linear system theory [6]. On the other hand, nullor-based models have been generated taking into account the ideal behavior of the active devices [7]. However the input-output resistance and capacitance, gain, input offset voltage or current and the frequency response are all finite. This is the reason to include these effects in the nullor-based models [8]. In this manner, any analog network can be modeled with nullors and impedances, and the equivalence between them is introduced in [8]-[11]. In this paper, the equivalent nullor model of the active circuit is a starting point for the sensitivity analysis. On the base of nullor

models using some network partial transfer functions, the CFG is used for the first-order sensitivity analysis of active networks [12]. This method was improved and simplified in [13], [14] using the modified Coates flow graph (MCFG). The symbolic equations generated by symbolic analysis help not only understand the first-order functional behavioral of an analog circuit, but also provide insight into second-order effects in the circuit. In some network-optimization schemes, it is desirable to know the dependence of first-order sensitivity on the elements of the network [4], [15]. In [16] the nullor model is combined with the MCFG aiming at the calculation of the multiparameter sensitivity (MS) in a symbolic form.

In this paper the process of obtaining first-, second-order and multiparameter symbolic sensitivity is automated and allows obtaining of all symbolic sensitivities simultaneously. The remaining work in this paper has been organized as follows. A detailed description of symbolic sensitivity analysis method, based on nullor model and modified Coates flow-graph, is presented in Section 2. In Section 3, the proposed method been applied to the nullor model of the STAR network for calculation of its first-, second-order and multiparameter symbolic sensitivities. Simulation results for the symbolic sensitivities of the voltage transfer function for the second-order high-pass filter are obtained. In Section 4, the conclusions are discussed.

II. NULLOR-MODIFIED COATES FLOW GRAPH SYMBOLIC SENSITIVITY ANALYSIS METHOD

A. Reduction of the Nullor Circuit Complexity

This section analyses a case when more than one parameter are likely to vary in a given circuit. Suppose that p parameters exist having very small fractional perturbations from their nominal values. According to [8]-[11] an equivalent nullor circuit N is composed by a designer. Let us assume that there are $m+n+R+1$ nodes, and R nullors in N . In accordance with [13], [14], the nodes, numbered from 1 to m represent network sources, nodes from $m+1$ to $m+n$ are inner nodes, that all or some of them can be considered as output nodes, and the node $m+n+1$ is the common node for the nullor circuit. The sequence of the nodes in the nullor circuit is determined as follows:

I.N. Asenova is with the Electrical Engineering Department, University of Transport, Sofia, Bulgaria (e-mail: irka_honey@yahoo.com).

- Incoming(sources) nodes - 1,..., m ;
- Outgoing nodes as follows:
 - h nodes, connected to edges with passive elements;
 - N_e nodes, connected with the ground by a norator;
 - $2N_f$ nodes, connected with N_f norators. According to [17] *when two or more norators have common nodes in the equivalent nullor circuit, then the pairs of the nodes connected with the norators must be numbered in ascending order in the income data of the algorithm for symbolic sensitivity analysis*;
 - N_{fr} nodes, connected with a norator that is situated between 2 nodes, one of them is connected with a nullator;
 - n'_f nodes that are one of the two nodes, connected with the nullators. According to [18] *when a nullator or more nullators are connected with the source node, because the source node is already numbered, this node is missed at that point*;
- $R = n_f + n_e$ nodes that are removed as follows:
 - n_f nodes, corresponding to the second node, connected with the nullators;
 - n_e nodes, connected with the nullators grounded.

Once the nullor circuit is established, a modification of the initial modified Coates flow-graph, representing the equivalent nullor circuit, is implemented. This modification reflects the nullor influence, reduces the nullor circuit complexity, and the admittance matrix respectively. Due to this modification, R vertices from the initial modified Coates flow-graph are removed. These vertices (nodes in the nullor

circuit) correspond to the number of nullators in the nullor circuit, and they are *strictly* determined, i.e. they are the *last ones* in the sequence of the numbering. In this manner, it is very clear between which two nodes the transfer function is determined after the admittance matrix reduction. The validity of the rules is verified by comparison of the reduced admittance matrix with the one obtained using the nullor properties described in [7]. In this section, a reduction of the nullor circuit complexity is implemented and some transformations of the initial modified Coates flow-graph are performed due to the rules described below:

Rule 1: When a node k in the nullor circuit, shown in Fig.1(a), is connected with the common node by a norator, all incoming edges, including the self-loop Y_{kk} , in vertex k in the corresponding flow-graph in Fig.1(b), are removed.

Rule 2: When a node k in the nullor circuit, shown in Fig.2(a), is connected with the common node by a nullator, all outgoing edges, including the self-loop Y_{kk} , in vertex k in the corresponding flow-graph in Fig. 2(b), are removed.

Rule 3: When a nullator is connected between a pair nodes k and l in the nullor circuit, shown in Fig. 3(a), all originals of the outgoing edges from vertex k , including the self-loop Y_{kk} , in the corresponding flow-graph in Fig. 3(b), are moved to vertex l . The equivalent flow-graph is shown in Fig. 3(c).

Rule 4: When a norator is connected between a pair nodes k and l in the nullor circuit, shown in Fig. 4(a), the ends of all incoming edges into vertex k , including the self-loop Y_{kk} , in the corresponding flow-graph in Fig. 4(b), are moved to vertex l . The equivalent flow-graph is shown in Fig. 4(c).

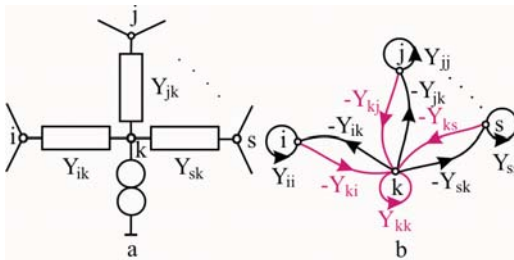

Fig. 1. Rule 1 of modification of the initial flow-graph.

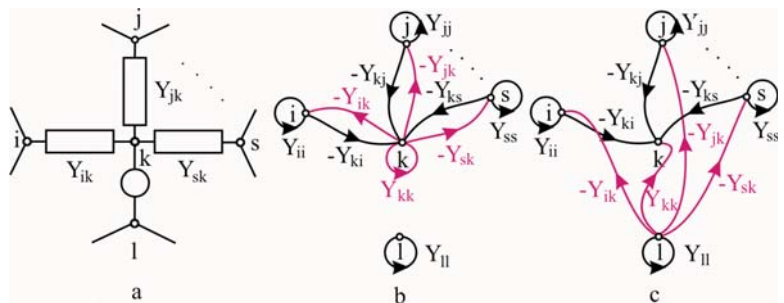

Fig. 3. Rule 3 of modification of the initial flow-graph.

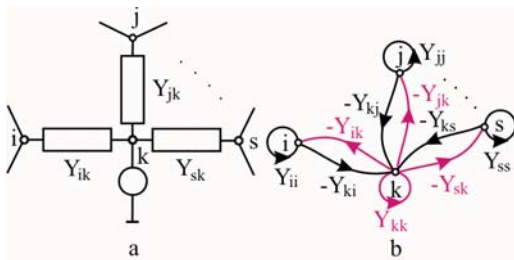

Fig. 2. Rule 2 of modification of the initial flow-graph.

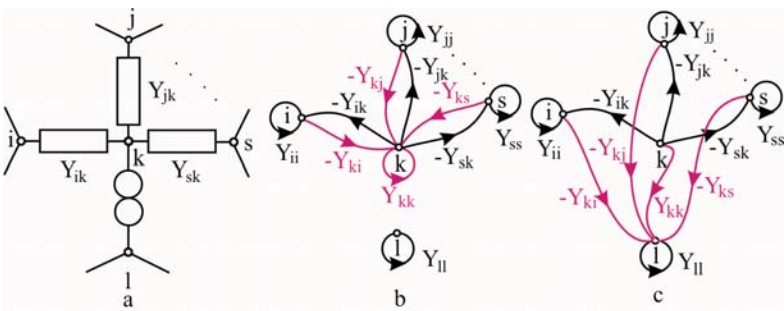

Fig. 4. Rule 4 of modification of the initial flow-graph.

The method looks for the definiteness of all outgoing vertices (nodes), i. e. each outgoing vertex has to have at least one incoming and one outgoing edge. Then the vertex is called determined one. This requirement is not performed for $(n-1)$ th vertex in Fig. 5(a). The method controls all l_i vertices, corresponding to nodes $R = n_f + n_e$ in the nullor circuit, respectively to R vertices in the modified Coates flow-graph. After performing of the rules, some of the vertices are incident with only incoming or outgoing edges. Figure 5(a) shows these vertices: $(n+1)$ th and $(n+2)$ nd one. Consequently l_i th vertex has to be united to the undetermined outgoing $(n-1)$ th vertex or the next determined outgoing n th vertex, shown in Fig. 5(b).

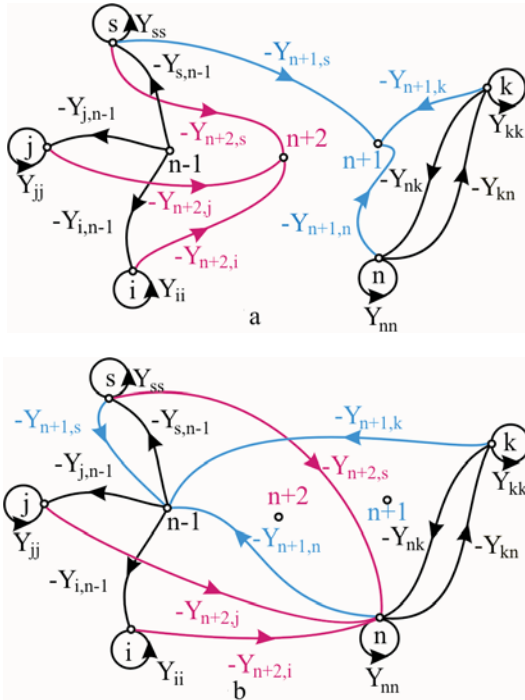

Fig. 5. Control for the definiteness of all outgoing vertices.

A. Determination of the partial transfer functions and the first-, second-order and multiparameter symbolic sensitivity

Voltage transfer function $T_{ba}(s)$ is under consideration. Then normalized first-, and second-order sensitivity, $S_{Y_1}^{T_{ba}}$ and $S_{Y_1 Y_2}^{T_{ba}}$, of rational transfer function $T_{ba}(s)$ with respect to circuit parameters $Y_1(s)$ and $Y_2(s)$ are respectively:

$$S_{Y_1(s)}^{T_{ba}(s)} = \frac{Y_1(s)}{T_{ba}(s)} \frac{\partial T_{ba}(s)}{\partial Y_1(s)} \frac{dY_{ji}(s)}{dY_1(s)} \quad (1)$$

$$S_{Y_1(s)Y_2(s)}^{T_{ba}(s)} = \frac{Y_1(s)Y_2(s)}{T_{ba}(s)} \frac{\partial^2 T_{ba}(s)}{\partial Y_1(s)\partial Y_2(s)}, \quad (2)$$

where

$$\frac{\partial^2 T_{ba}(s)}{\partial Y_1(s)\partial Y_2(s)} = \frac{\partial T_{ia}(s)}{\partial Y_1(s)} \frac{dY_{kl}(s)}{dY_2(s)} T_{bj}(s) + \frac{\partial T_{bj}(s)}{\partial Y_{kl}(s)} \frac{dY_{kl}(s)}{dY_2(s)} T_{ia}(s), \quad (3)$$

$Y_{ji}(s) = a_{ji}(s) + Y_1(s)$ and $Y_{kl}(s) = a_{kl}(s) + Y_2(s)$ are edges of the MCFG and elements of reduced admittance matrix $\mathbf{Y}(s)$; $a_{ji}(s)$ and $a_{kl}(s)$ contain other network parameters, for $a, i, l = 1, \dots, m+n$; $b, j, k = m+1, \dots, m+n$.

The MCFG allows us to simplify the sensitivity analysis on the base of certain network partial transfer functions. According to [19], derivatives $\partial T_{ba}(s)/\partial Y_{ji}(s)$ in (1), $\partial T_{ia}(s)/\partial Y_{kl}(s)$ and $\partial T_{bj}(s)/\partial Y_{kl}(s)$ in (2) are as follow:

$$\begin{aligned} \partial T_{ba}(s)/\partial Y_{ji}(s) &= T_{ia}(s)T_{bj}(s) \\ \partial T_{ia}(s)/\partial Y_{kl}(s) &= T_{ia}(s)T_{ik}(s) \\ \partial T_{bj}(s)/\partial Y_{kl}(s) &= T_{lj}(s)T_{bk}(s). \end{aligned} \quad (4)$$

When parameters $Y_1(s)$ and $Y_2(s)$ simultaneously participate in more then one edge in the modified Coates flow graph, respectively in the reduced admittance matrix $\mathbf{Y}(s)$, the first- and second-order symbolic sensitivities are respectively:

$$S_{Y_1(s)}^{T_{ba}(s)} = \frac{Y_1(s)}{T_{ba}(s)} \sum_{ji} T_{ia}(s)T_{bj}(s) \frac{dY_{ji}(s)}{dY_1(s)} \quad (5)$$

$$\begin{aligned} S_{Y_1(s)Y_2(s)}^{T_{ba}(s)} &= \frac{Y_1(s)Y_2(s)}{T_{ba}(s)} \\ &\cdot \left[\sum_{ji} T_{bj} \sum_{kl} T_{la}T_{ik} \frac{dY_{kl}(s)}{dY_2(s)} + \sum_{ji} T_{ia} \sum_{kl} T_{lj}T_{bk} \frac{dY_{kl}(s)}{dY_2(s)} \right] \end{aligned} \quad (6)$$

or

$$S_{Y_1(s)}^{T_{ba}(s)} = \frac{Y_1(s)}{\Delta_{ba}\Delta} \sum_{j,i} \Delta_{ia}\Delta_{bj} \frac{dY_{ji}(s)}{dY_1(s)} \quad (7)$$

$$\begin{aligned} S_{Y_1(s)Y_2(s)}^{T_{ba}(s)} &= \frac{Y_1(s)Y_2(s)}{\Delta_{ba}\Delta^2} \\ &\cdot \left[\sum_{ji} \Delta_{bj} \sum_{kl} \Delta_{la}\Delta_{ik} \frac{dY_{kl}(s)}{dY_2(s)} + \sum_{ji} \Delta_{ia} \sum_{kl} \Delta_{lj}\Delta_{bk} \frac{dY_{kl}(s)}{dY_2(s)} \right]. \end{aligned} \quad (8)$$

Determinants Δ_{ba} , Δ_{ia} , Δ_{la} , and Δ_{bj} , Δ_{bk} , Δ_{ik} , Δ_{lj} , and Δ can be obtained by the modified Coates flow-graph and its sub-graphs \mathbf{G}_{k1}^{MC} , \mathbf{G}_{kj}^{MC} and \mathbf{G}_0^{MC} , respectively, as follows:

- \mathbf{G}_0^{MC} is obtained by \mathbf{G}^{MC} due to the removal of all outgoing edges from the vertex-source;

- \mathbf{G}_{k1}^{MC} , for $k = 2, \dots, n$, is obtained from \mathbf{G}^{MC} due to the removal of all outgoing edges, including the self-loop in the vertex k with a signal $V_k(s)$ and moving the vertex-source into the vertex k . As a result follows $Y_{jk} = 0$, $Y_{kk} = 0$ and the originals of the outgoing edges from the vertex-source are moved toward the vertex k ;
- \mathbf{G}_{kj}^{MC} is obtained from \mathbf{G}_0^{MC} by removing all outgoing edges, including the self-loop, from the vertex k , as well as by removing all incoming edges, including the self-loop, from the vertex j and must be added an edge $Y_{jk} = -1$.

Consequently

$$\Delta_{kq} = \sum_{Q=1}^R (-1)^{N_Q} P_Q, \tag{9}$$

where

N_Q - is the number of the loops in the Q -th separation of

loops in the sub-graph;

R - the number of separations from loops in the sub-graph;

P_Q - the product of loop transmission coefficients in Q -th

separation of loops in the sub-graph. Every separation of loops must be incident to all graph vertices and every one vertex must be incident with only one incoming edge and one outgoing edge.

The method suggested in this paper performs multiparameter sensitivity analysis with respect to various circuit parameters too [16]. Magnitude of multiparameter symbolic sensitivity MS^T of transfer function $T_{ba}(s)$ is

$$MS^T = \sum_{i=1}^p |S_{Y_i}^T| . \tag{10}$$

The sequence of the main steps of the suggested method of first-, second-order and multiparameter symbolic sensitivity analysis is as follows:

1. Compose the equivalent nullor circuit of the active network.
2. Get the information about the network function required and the elements with respect to which the sensitivities are to be calculated. Determine the location of the nullators and norators.
3. Formulate the symbolic admittance matrix.
4. Perform symbolic reduction of nullor circuit complexity (initial modified Coates flow graph) using the rules for transformation in order to reflect the nullor effect.
5. Calculate the partial transfer functions and the relevant determinants of the sub-graphs.
6. Calculate the first-order symbolic sensitivity of the transfer function by applying (7).
7. Calculate the second-order symbolic sensitivity of the transfer function by applying (8).
8. Calculate the multiparameter symbolic sensitivity of the transfer function by applying (10).

The method suggested automatically performs the rules of modification, generates the symbolic admittance reduced matrix, determinants, partial transfer functions, first-, second-order and multiparameter symbolic sensitivity with respect to parameters in the circuit. The interested readers can receive the software from Irka_honey@yahoo.com.

III. EXAMPLES

Example 1. A circuit example, taken from [4], is shown in Fig. 6 to illustrate the proposed method. The first- and second-order symbolic sensitivities of the transfer function $T(s) = U_3 / U_1$ with respect to parameters G_4 and sC_2 are calculated. Multiparameter symbolic sensitivity $MS^{T_{31}}$ is obtained too. The equivalent nullor circuit N is composed and shown in Fig. 7.

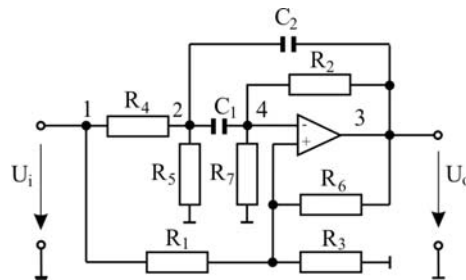

Fig. 6. The STAR network.

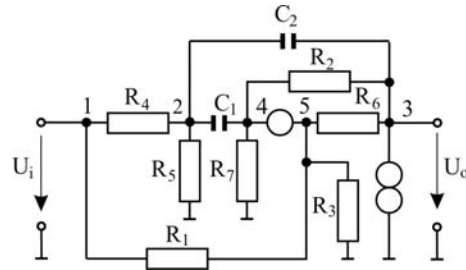

Fig. 7. Equivalent nullor circuit.

An initial form of the MCFG for the passive part of the network is shown in Fig. 8(a). The node corresponding to the vertex in the initial flow-graph that is removed has number 5.

After applying the rules of modification, the modified Coates flow-graph follows, represented in Fig. 8(b).

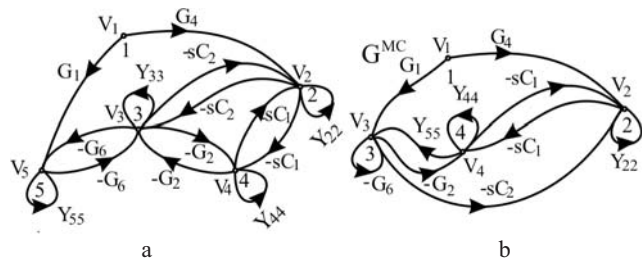

Fig. 8. Initial and modified Coates flow graphs.

We suppose that voltage transfer function T_{31} is under consideration. When $Y_1(s) = G_4$ and $Y_2(s) = sC_2$ from the MCFG (Fig.8b) follows: $Y_{21} = G_4$, $Y_{22} = G_4 + sC_2 + a_{22}$, $Y_{23} = -sC_2$, for $a_{22} = G_2 + sC_1$.

Taking into account (5) first-order symbolic sensitivities $S_{G_4}^{T_{31}}$ and $S_{sC_2}^{T_{31}}$ are respectively:

$$S_{G_4}^{T_{31}} = \frac{G_4}{T_{31}} \frac{\partial T_{31}}{\partial G_4} = \frac{G_4}{T_{31}} \left(\frac{\partial T_{31}}{\partial Y_{21}} \frac{dY_{21}}{dG_4} + \frac{\partial T_{31}}{\partial Y_{22}} \frac{dY_{22}}{dG_4} \right) = \frac{G_4}{T_{31}} (T_{11}T_{32} + T_{21}T_{32}) = \frac{G_4}{\Delta_{31}} \left(1 + \frac{\Delta_{21}}{\Delta} \right) \Delta_{32} \quad (11)$$

$$S_{sC_2}^{T_{31}} = \frac{sC_2}{T_{31}} \frac{\partial T_{31}}{\partial sC_2} = \frac{sC_2}{T_{31}} \left(\frac{\partial T_{31}}{\partial Y_{22}} \frac{dY_{22}}{dsC_2} + \frac{\partial T_{31}}{\partial Y_{23}} \frac{dY_{23}}{dsC_2} \right) = \frac{sC_2}{T_{31}} (T_{21}T_{32} - T_{31}T_{32}) = \frac{sC_2}{\Delta_{31}\Delta} (\Delta_{21} - \Delta_{31}) \Delta_{32} \quad (12)$$

For determination of the first-order sensitivities *four* sub-graphs and their solutions are required: Δ_{21} , Δ_{31} , Δ_{32} are obtained using sub-graphs G_{21}^{MC} , G_{31}^{MC} and G_{32}^{MC} , respectively, shown in Fig. 9. Determinant Δ together with the possible combinations of loops (1F's) and their products are obtained using sub-graph G_0^{MC} , shown in Fig. 10.

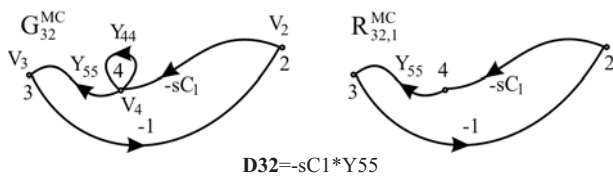
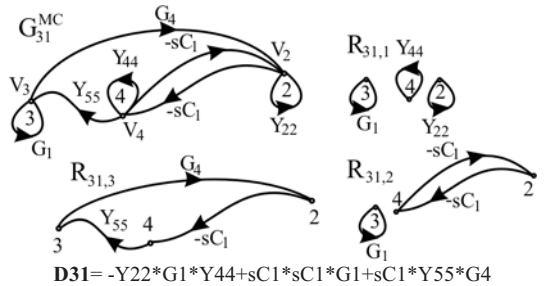
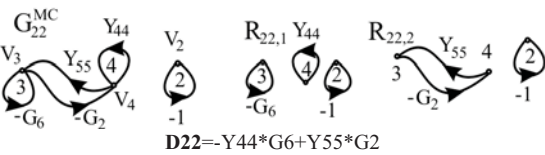
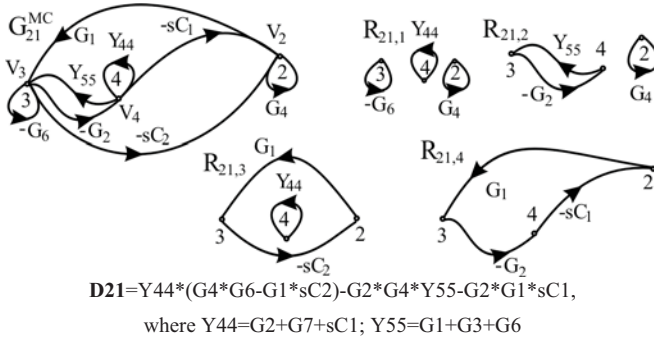

Fig. 9. Sub-graphs G_{21}^{MC} , G_{22}^{MC} , G_{31}^{MC} , G_{32}^{MC} and their 1F's.

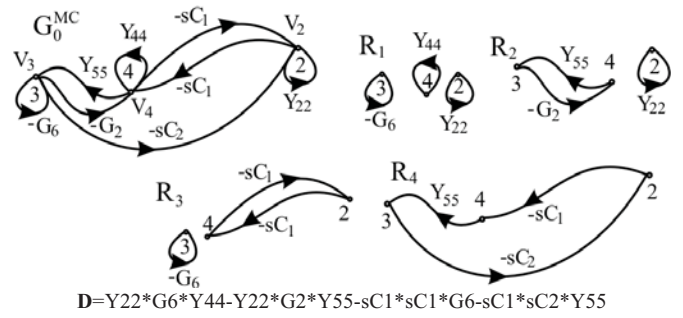

Fig. 10. Sub-graph G_0^{MC} and its 1F's.

Taking into account (6) and (8) second-order symbolic sensitivity $S_{G_4, sC_2}^{T_{31}}$ is respectively:

$$S_{G_4, sC_2}^{T_{31}} = \frac{G_4 sC_2}{T_{31}} \cdot [(T_{21}T_{22} - T_{31}T_{22})T_{32} + (T_{22}T_{32} - T_{32}T_{32})(T_{11} + T_{21})] \quad (13)$$

$$S_{G_4, sC_2}^{T_{31}} = \frac{G_4 sC_2}{\Delta_{31}\Delta} \cdot \left[\frac{(\Delta_{21} - \Delta_{31})\Delta_{22}\Delta_{32}}{\Delta} + (\Delta_{22} - \Delta_{32})\Delta_{32} \left(1 + \frac{\Delta_{21}}{\Delta} \right) \right] \quad (14)$$

For determination of the second-order sensitivity is required only *one* sub-graph G_{22}^{MC} more shown in Fig. 9.

According to (10) the method suggested calculates the magnitude of multiparameter sensitivity $MS^{T_{31}}$ of transfer function T_{31} with respect to all parameters:

$$MS^{T_{31}} = \sum_{i=1}^7 |S_{G_i}^{T_{31}}| + \sum_{i=1}^2 |S_{sC_i}^{T_{31}}|, \quad (15)$$

where

$$\begin{aligned} S_{G_1}^{T_{31}} &= \frac{G_1}{T_{31}} \frac{\partial T_{31}}{\partial G_1} = \frac{G_1}{\Delta_{31}} \left(1 + \frac{\Delta_{41}}{\Delta} \right) \Delta_{33} \\ S_{G_2}^{T_{31}} &= \frac{G_2}{T_{31}} \frac{\partial T_{31}}{\partial G_2} = \frac{G_1}{\Delta_{31}\Delta} (\Delta_{41} - \Delta_{31}) \Delta_{33} \\ S_{G_3}^{T_{31}} &= \frac{G_3}{T_{31}} \frac{\partial T_{31}}{\partial G_3} = \frac{G_3}{\Delta_{31}\Delta} \Delta_{41} \Delta_{33} \\ S_{G_6}^{T_{31}} &= \frac{G_6}{T_{31}} \frac{\partial T_{31}}{\partial G_6} = \frac{G_6}{\Delta_{31}\Delta} (\Delta_{41} - \Delta_{31}) \Delta_{33} \\ S_{G_7}^{T_{31}} &= \frac{G_7}{T_{31}} \frac{\partial T_{31}}{\partial G_7} = \frac{G_7}{\Delta_{31}\Delta} \Delta_{41} \Delta_{34} \\ S_{sC_1}^{T_{31}} &= \frac{sC_1}{T_{31}} \frac{\partial T_{31}}{\partial sC_1} = \frac{sC_1}{\Delta_{31}\Delta} (\Delta_{21} - \Delta_{41}) (\Delta_{32} - \Delta_{34}). \end{aligned} \quad (16)$$

For determination of multiparameter sensitivity are required only *seven* sub-graphs (G_{21}^{MC} , G_{31}^{MC} , G_{41}^{MC} , G_{32}^{MC} , G_{33}^{MC} , G_{34}^{MC} and G_0^{MC}).

Example 2. Let us find the symbolic first- and second-order sensitivities of voltage transfer function $T(s)=U_3/U_1$ for the second-order high-pass filter shown in Fig. 11. Simulation results for $R_1 = R_2 = R_3 = R_4 = 100 \Omega$, $C_1 = 0.00005 \text{ F}$ and $C_2 = 0.0001 \text{ F}$ of the above sensitivities versus frequency f are obtained.

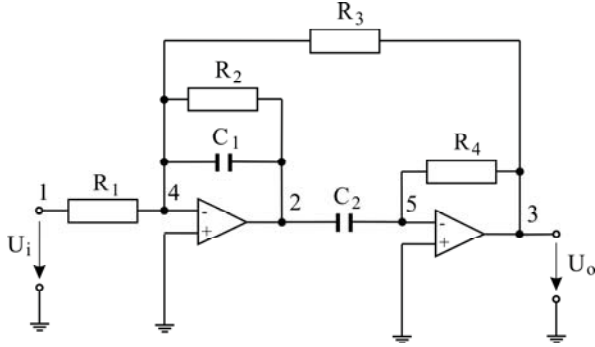

Fig. 11. Second-order high-pass filter.

Considering the sequence of numbering, vertices (nodes) 4 and 5 are removed. These nodes are *strictly* determined in the input data. After performing of the rules, the modified Coates flow graph is obtained and presented in Fig. 12.

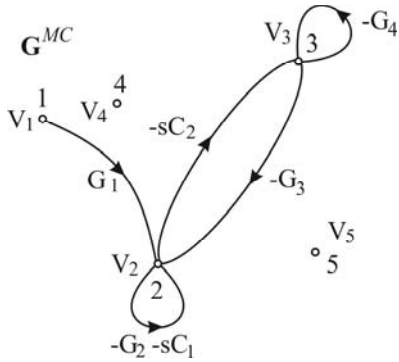

Fig. 12. Modified Coates flow graph G^{MC} .

Using Mathcad software voltage transfer function $T_{31}(s)$ versus frequency f is shown in Fig.13

$$T_{31} = \frac{G_1 s C_2}{(G_2 + s C_1) G_4 - s C_2 G_3} \quad (17)$$

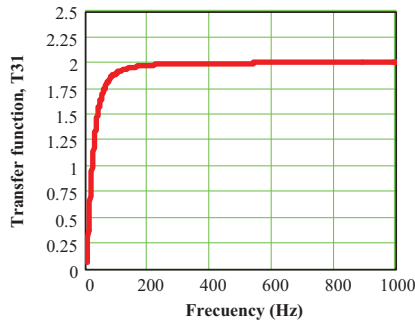

Fig. 13. Frequency-response plot for the circuit in Fig. 11.

$$T_{31M_k} := \sqrt{(\text{Re}(T_{31_k}))^2 + (\text{Im}(T_{31_k}))^2}$$

Taking into account (5) and (6) first-, and second-order symbolic sensitivities $S_{G_2}^{T_{31}}$, $S_{G_3}^{T_{31}}$ and $S_{G_2 G_3}^{T_{31}}$ are respectively:

$$\begin{aligned} S_{G_2}^{T_{31}} &= \frac{G_2}{T_{31}} \frac{\partial T_{31}}{\partial G_2} = \frac{G_2}{T_{31}} \frac{\partial T_{31}}{\partial Y_{22}} \frac{dY_{22}}{dG_2} = \\ &= \frac{G_2}{T_{31}} (-T_{21} T_{32}) = \frac{G_2}{\Delta_{31} \Delta} (-\Delta_{21} \Delta_{32}) \end{aligned} \quad (18)$$

$$\begin{aligned} S_{G_3}^{T_{31}} &= \frac{G_3}{T_{31}} \frac{\partial T_{31}}{\partial G_3} = \frac{G_3}{T_{31}} \frac{\partial T_{31}}{\partial Y_{23}} \frac{dY_{23}}{dG_3} = \\ &= \frac{G_3}{T_{31}} (-T_{31} T_{32}) = \frac{G_3}{\Delta} (-\Delta_{32}) \end{aligned} \quad (19)$$

$$\begin{aligned} S_{G_2 G_3}^{T_{31}} &= \frac{G_2 G_3}{T_{31}} \frac{\partial^2 T_{31}}{\partial Y_{22} \partial Y_{23}} = \frac{G_2 G_3}{T_{31}} \left(\frac{\partial T_{21}}{\partial Y_{23}} T_{32} + \frac{\partial T_{32}}{\partial Y_{23}} T_{21} \right) = \\ &= \frac{G_2 G_3}{\Delta_{31} \Delta} \left[\frac{(-\Delta_{31} \Delta_{22} - \Delta_{32} \Delta_{21}) \Delta_{32}}{\Delta} \right], \end{aligned} \quad (20)$$

where

$$\begin{aligned} D_{21_k} &:= -G_1 \cdot G_4 & D_{22_k} &:= G_4 \\ D_{31_k} &:= G_1 \cdot s_k \cdot C_2 & D_{32_k} &:= -(s_k) \cdot C_2 \\ D_k &:= (G_2 + s_k \cdot C_1) \cdot G_4 - s_k C_2 \cdot G_3 \end{aligned}$$

For determination of the first- and second-order symbolic sensitivities $S_{G_2}^{T_{31}}$, $S_{G_3}^{T_{31}}$ and $S_{G_2 G_3}^{T_{31}}$, four, two and five sub-graphs and their solutions are required respectively.

Using Mathcad software symbolic sensitivity simulation results versus frequency f are shown in Fig. 14.

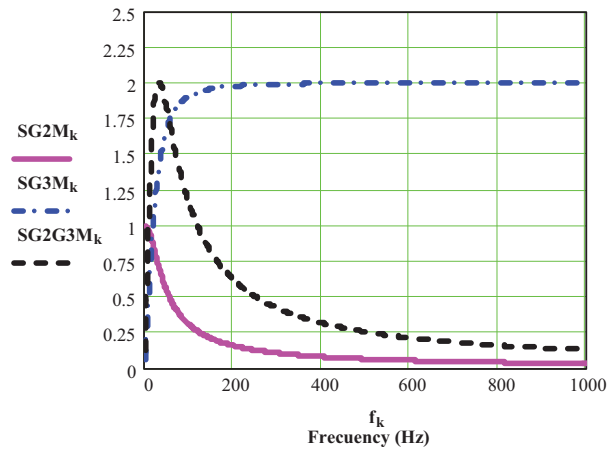

Fig. 14. First-, and second-order symbolic sensitivities $S_{G_2}^{T_{31}}$, $S_{G_3}^{T_{31}}$ and $S_{G_2 G_3}^{T_{31}}$ versus frequency f .

$$k := 1..1000$$

$$f_k := k \quad j := \sqrt{-1}$$

$$w_k := 2 \cdot 3.14 \cdot f_k$$

$$s_k := j \cdot (w_k)$$

$$SG2_k := \frac{-G2}{D31_k \cdot D_k} \cdot D21_k \cdot D32_k$$

$$SG3_k := \frac{-G3}{D_k} \cdot D32_k$$

$$SG2G3_k := \frac{G2 \cdot G3}{D31_k \cdot D_k} \cdot \left(\frac{-D31_k D22_k - D32_k \cdot D21_k}{D_k} \right) \cdot D32_k$$

$$SG2M_k := \sqrt{(\text{Re}(SG2_k))^2 + (\text{Im}(SG2_k))^2}$$

$$SG3M_k := \sqrt{(\text{Re}(SG3_k))^2 + (\text{Im}(SG3_k))^2}$$

$$SG2G3M_k := \sqrt{(\text{Re}(SG2G3_k))^2 + (\text{Im}(SG2G3_k))^2}$$

As it is seen, the sensitivity analysis method based on the nullor model and modified Coates flow-graph can be implemented in circuit design process and for circuit characterization, successfully.

IV. CONCLUSION

A new method of first-, second-order and multiparameter symbolic sensitivity determination is considered. It is based on the equivalent nullor model of active devices and modified Coates flow graph. An algorithm for the first-, second-order sensitivity analysis with respect to the circuit parameters that participate in more than one edge in the modified Coates flow graph, respectively in the reduced admittance matrix, is proposed. The method suggested automatically can generate symbolic admittance reduced matrix, determinants, partial transfer functions, symbolic first-, second-order and multiparameter sensitivities. Simulation results of the first- and second-order sensitivities versus frequency for the second-order high-pass filter are obtained. The advantages of the method are that, the matrix inversion is not required and the main drawback of some methods based on the adjoint graph, i.e. the necessity to analyze the corresponding graph twice, is avoided.

REFERENCES

- [1] H. Yang, M. Ranian, W. Verhaeden, M. Ding, R. Vemuri, and G. Gielen, "Efficient symbolic sensitivity analysis of analog circuits using element-coefficient diagrams," Proceedings of the ASP-Design Automation Conference, vol. 1, pp. 230-235, Jan. 2005.
- [2] F. Balik and B. Rodanski, "Calculation of symbolic sensitivities for large-scale circuits in the sequence of expressions form via the transimpedance method," Analog Integrated Circuits and Signal Processing, 40, pp. 265-276, 2004.
- [3] A. Andonov and Z. Hubenova, Functional stability of information control complexes in case of their critical applications, University of Transport, Sofia, 2011, 174 p., ISBN 978-954-12-0192-3.
- [4] F. Balik and B. Rodanski, "Calculation of first- and second-order symbolic sensitivities in sequential form via the transimpedance method," Proc. ECCTD'99, pp. 70-73, 1999.
- [5] G. A. Nenov and I. N. Georgieva, "Determination of signal-flow-graph transfer function sensitivity using first- and second-order derivatives and graphs," 5-th Electronic Devices and Systems Conference, Brno, Czech Republic, pp. 291-294, 1998.
- [6] M. Fakhfakh and M. Pierzchala, "Computing symbolic transfer functions of CC-based circuits using Coates flow-graph," 5th International Conference on Design and Technology of Integrated Systems in Nanoscale Era, 10.1109/DTIS.2010.5487579, 2010.
- [7] A. C. Davies, "Nullator-norator equivalent networks for controlled sources," Proc. IEEE, vol.55, No.5, pp.722-723, 1967.
- [8] M. Fakhfakh, E. Tlelo-Cuautle, and F.V. Fernández (Eds.), *Design of Analog Circuits through Symbolic Analysis*. Bentham Science Publishers Ltd., 2011, ch. 3, to be published.
- [9] B. D. Donevsky, G. A. Nenov, *Application of Signal-Flow Graph in the Electronic circuits Analysis and Synthesis*. Technika, Sofia, 1976.
- [10] M. Fakhfakh, M. Loulou and N. Masmoudi, "Optimizing current conveyors using the nullor concept," The IXth International Workshop on Symbolic Methods and Applications to Circuit Design SMACD 2006, Oct. 21-13. Firenze, Italy.
- [11] E. Tlelo-Cuautle, C. Sánchez-López, E. Martínez-Romero and Sheldon X.-D. Tan, "Symbolic analysis of analog circuits containing voltage mirrors and current mirrors," Analog Integrated Circuits and Signal Processing, vol. 65, no. 1, pp. 89-95, DOI: 10.1007/s10470-010-9455-y
- [12] G. A. Nenov, "Determination of first-order nullor network transfer function sensitivity by using Coates signal-flow graphs," International Symposium on Signals, Circuits and Systems, vol.2, pp. 345 - 348, 2003.
- [13] I. Asenova, "Topological analysis of electrical circuit sensitivity" (Топологичен анализ на чувствителността на електрически вериги), PhD Thesis, University of Transport, Bulgaria, 2008.
- [14] I. N. Asenova, "Symbolic sensitivity analysis using nullators, norators and modified Coates signal flow graph," Proc. IEEE 50th International Symposium Elmar, Zadar, Croatia, ID 38, pp. 245-248, Sept. 2008.
- [15] Asenova I., "Calculation of Second-Order Symbolic Sensitivity by Using Nullor Model and Modified Coates Flow Graph" - 18th International Conference Mixed Design of Integrated Circuits and Systems (MIXDES), Gliwice, Poland, pp. 587-591, June 2011.
- [16] Asenova I., D. Georgiev, M. Mihova, „Multiparameter Symbolic Sensitivity Analysis by Using Nullor Model and Coates Flow Graphs”, XIth International Workshop on Symbolic and Numerical Methods, Modeling and Applications to Circuit Design (SM2ACD), Gammath, Tunisia, Paper ID 01-17-06, pp.1-4, 2010.
- [17] I. Asenova and D. Georgiev, "Some special cases of symbolic sensitivity analysis using nullators and norators - part II," The Jubilee research conference "Innovations on railway transport -2009", Sanct Petersburg, pp. 37-42, September 2009.
- [18] I. Asenova, "Some special cases of symbolic sensitivity analysis using nullators and norators- part I," 9th International Conference on Applied Electromagnetics PES, Nis, pp. 107-108, 2009 [Digests]
- [19] A. Fettwies, "Some general properties of signal-flow networks," in Network and Signal Theory (edited by J. K. Skwirzynski and J. O. Scanlan), Peter Peregrinus Ltd., London, 1973.

Irina N. Asenova received the M.Sc. degree in 1985 and the Ph.D. degree in 2008, both in Electrical Engineering, from the Technical University in Sofia, Bulgaria.

In 1985 she joined Minstroy Holding JSC to work on industrial projects as an ELECTRICAL DESIGNER. In 1990 she joined the faculty Telecommunications and Electrical Equipment in Transport, University of Transport, Sofia, where she currently is a PROFESSOR ASSISTANT. She is a co-author of a chapter on symbolic analysis of analog circuits by flow-graphs in the Design of Analog Circuits through Symbolic Analysis, Bentham Science Publishers Ltd., 2011. Her research interests include load forecast in the electrical energy system, symbolic analysis of analog circuits, symbolic sensitivity analysis using the modified Coates flow graph and the nullor models of active devices.

Dr. Asenova worked for Microelectronics Journal, International Journal of Circuit Theory and Applications, ICECS2010, IEEE Transactions on Circuits and Systems I as a reviewer.