

# Measurement and Performance Evaluation of a Silicon On Insulator Pixel Matrix

Dimitrios Ntavelis, Louis Harik, Jean-Michel Sallese, Maher Kayal, and Alkis Hatzopoulos

**Abstract**—A new technique for driving silicon-on-insulator pixel matrixes has been proposed in [1], which was based on transient charge pumping for evacuating the extra photo-generated charges from the body of the transistor. An 8x8 pixel matrix was designed and fabricated using the above technique. In this paper, the measurement set-up is described and the performance evaluation procedure is given, together with results of its implementation on the fabricated pixel matrix. The results show the applicability of the charge pumping technique and the effective operation of the image sensor.

**Index Terms**—SOI MOSFET, Image Sensors, Charge Pumping, First Order Delta-Sigma

## I. INTRODUCTION

SILICON On Insulator (SOI) is a technology offered as an alternative to the conventional CMOS technology, since it overcomes some of its drawbacks and limitations. Most of the advantages of SOI technology are exploited in high frequency and low power applications.

However, this technology is not so widely used in image sensors, as it is used, for example, in the design of the CPUs and dynamic memories [2-3]. Two basic drawbacks of the SOI transistors, which limit their efficiency and dominate over their advantages, is the reason for this situation. The first disadvantage is the slow time recovery [4] of the electron-hole pairs which get separated after the illumination. Because of this fact, the decay of the drain current is rather slow and the SOI phototransistors are not sufficiently fast and thus not useful for many applications, like image sensors. The second disadvantage is the fact that under illumination the separation of the electron-hole pairs is slow and additionally it is dependent on the level of the incoming light. So, it is impossible to measure intensities as low as  $2\text{mW/m}^2$  due to the noise effects [5-6].

A new technique to overcome these major disadvantages of partially depleted floating body SOI MOSFET is proposed in [1]. This new technique is based on the use of transient charge pumping when the pixel is not in the reading phase in order to evacuate the extra photo generated charges from the body of the phototransistor. Using the new light sensing technique, a

This work was financially supported by E.P.F.L., Lausanne, Switzerland, in the frame of the “Joint Supervision of Diploma thesis” project between E.P.F.L. and the School of Engineering of A.U.TH.

D. Ntavelis and Prof. A. Hatzopoulos are with the Department of Electrical and Computer Engineering, at the Aristotle University of Thessaloniki, Electronics Lab., 54124, Thessaloniki, Greece.

Prof. M. Kayal, J.-M. Sallese and L. Harik are with the Electrical Engineering Department, at the Ecole Polytechnique Fédérale de Lausanne, STI-IEL- ELB 331, station 11 1015 Lausanne, Switzerland.

Corresponding author: Louis Harik (e-mail: louis.harik@gmail.com).

new pixel architecture was developed and then a chip including a matrix of  $8 \times 8$  pixels was designed.

In this work, the performance evaluation of the designed and fabricated chip is presented. The next section describes the matrix architecture of the image sensor and the modes of operation of each pixel. Section III describes the measuring system that was developed to implement the reading algorithm of the pixel, drive the matrix and process the output data. The measurement results of the implementation are shown in section IV. Finally, section V concludes our paper including proposals for future work

## II. PIXEL MATRIX ARCHITECTURE AND OPERATING MODE

An  $8 \times 8$  pixel matrix, based on the explanation given in the introduction, was built for research purpose.

### A. The Matrix Architecture

The schematic view of the matrix architecture is shown in figure 1. The reading is done column-wise, as the 3 to 8 decoder enables one column of pixels at a time. Also, the matrix includes a current reference for each line, a voltage sense amplifier for each bit line and the active pixel area. The current reference is implemented by a matched current source which can be shared among different pixels of a row because they do not use it at the same time. The voltage sense amplifier at the end of the bit line is used to detect the slightest change in the line and to amplify it. Additionally, it is essential for the conversion of the analog output of the active pixel area to the binary output of the pixel.

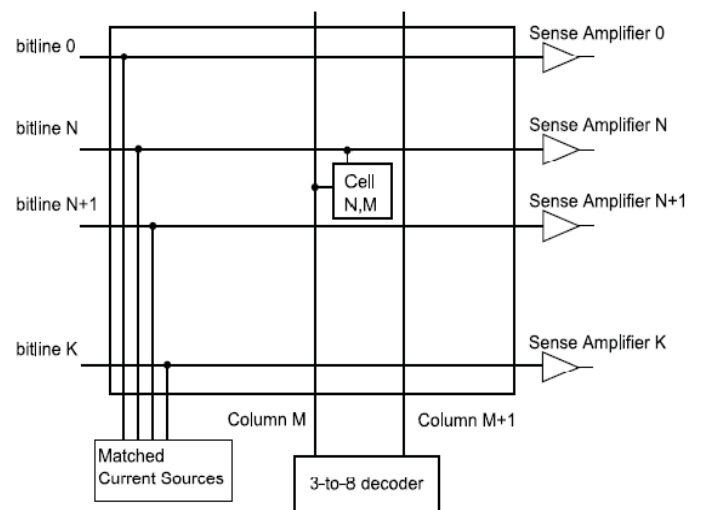

Fig. 1. Pixel Matrix Architecture.

### B. Delta-Sigma modulator – the Comparator

A Delta-Sigma modulator (fig. 2) is built-in each pixel. This Delta-Sigma modulator improves the sensitivity of the pixel by increasing its oversampling ratio (OSR) [7]. Also, it is pointed out that the operating mode of the pixel is based on the fact that under illumination the drain current of the phototransistor is increased, so the incoming light can be quantified by measuring this current. The Delta-Sigma modulator compares the drain current of the phototransistor to the current reference of the bit line and sets the output voltage of the bit line. When the current reference is higher than the drain current, the voltage of the bit line goes low, otherwise it goes high. In addition to this, the delta sigma modulator is very useful for the operation of the charge pumping pulses. When the output of the current comparator is low, it enables switches that activate the charge pumping pulses and apply them on the gate of the phototransistor.

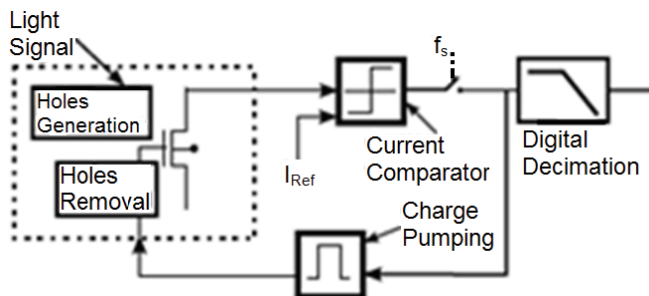

Fig. 2. The way that different parts of the Delta-Sigma modulator are implemented on the matrix.

### C. The Pixel

The pixel architecture is shown in figure 3. The pixel has two phases per cycle, the reading phase and the charge pumping phase. When the pixel is in the reading phase, the reading voltage is applied to the gate of the phototransistor. The level of this signal should be low to avoid generation of electron-hole pairs in the floating body of the transistor due to impact ionization (known as the king effect). Under illumination, the photo generated charges increase the drain current which is driven through transistor  $M_2$  to the current comparator. The comparator stabilizes its output, which is then driven to a memory element (D flip-flop) and is latched

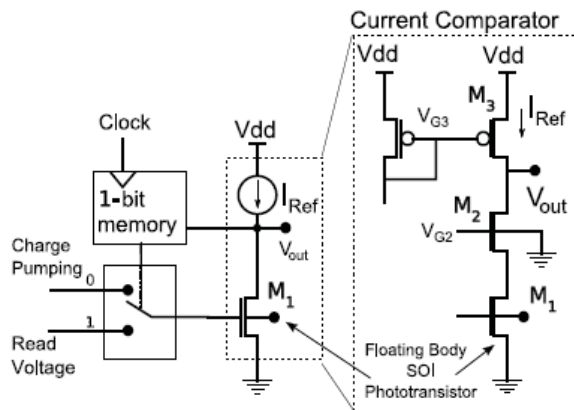

Fig. 3. Block diagram of the Pixel

by it. During the charge pumping phase, depending on the comparison between the current reference and the drain current, the charge pumping pulses are connected or not to the gate of the phototransistor. Also, in this phase, the phototransistor is disconnected from the circuit, by switching off transistor  $M_2$ , in order to minimize current consumption.

## III. THE MEASURING SYSTEM

The image sensor was placed on a printed circuit board which was built to connect the pixel matrix to a microcontroller unit and a terminal and apply the signals which are required for the matrix operation.

### A. The Microcontroller Unit

A microcontroller unit was used to implement the reading algorithm of the pixel matrix and to drive the chip. In addition to this, the microcontroller could collect the output data of the chip, store and process them. The microcontroller was also useful to send the data to an external terminal for extended procession and results' display. The model, which was selected, was the PIC 16F887 from Microchip.

According to the reading algorithm of the pixel and the matrix architecture, the operation of the microcontroller unit includes the following actions:

1. Select the reading column of the matrix,
2. Supply the signal that controls the two phases of the pixels,
3. Enable the sense amplifier,
4. Get the eight outputs of the column,
5. Send the outputs to a terminal through the RS232 port.

Due to the need to achieve the best baud rate (115,200 Kbits) and the least percentage error (0% error) in the communication between the microcontroller and the computer, an external clock of 18.432 MHz was added to clock the microcontroller unit. It is underlined that the clock frequency of the microcontroller affects the speed imaging of the image sensor as it supplies on it the signal that controls the two phases of a pixel. The higher the speed of the microcontroller is, the faster the rotation between the reading phase and the charge pumping phase.

### B. The Printed Circuit Board

A printed circuit board was built in order to be able to program the microcontroller unit according to the need of each measurement and to supply the required signals to the pixel matrix. It was also used to open communication with a terminal so as to send the output data and process them. As shown in figure 4, the printed circuit board includes the chip of the SOI sensor at the left side of the board, the microcontroller unit and its reset circuit, a MAX232 circuit and the external clock for the microcontroller. Additionally, on the board there are pins for the connection of the microcontroller to the programming device.

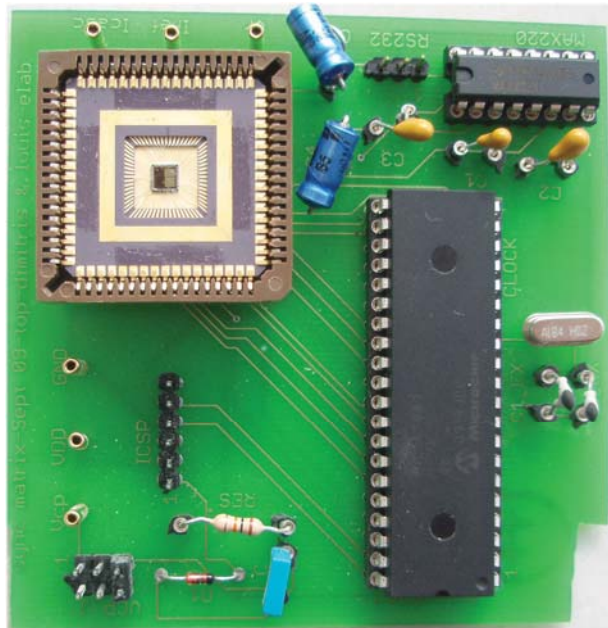

Fig. 4. The Printed Circuit Board.

#### IV. MEASUREMENT RESULTS

The most important attributes of a pixel matrix is the sensitivity, the fixed pattern noise, the dynamic range and the signal to noise ratio. Other characteristics that are important to achieve a high performance image sensor are the power consumption and the voltage operation. Also, the speed imaging is important in case of video applications.

##### A. Sensitivity

One of the most interesting attributes that characterize the pixel matrix is the sensitivity. In order to display it, two features are essential, the fill factor and the quantum efficiency. Fill factor is the ratio of the active pixel area to the total area of the pixel. Between pixels with the same size, the one with the maximum fill factor value will have shorter response times and it will be faster. Furthermore, quantum efficiency is the ratio of the photo-generated electrons due to the illumination on the active pixel area to the incident photons on the whole pixel. In fact, the sensitivity is the ability of a pixel to detect low light intensities. The lower the light intensity a pixel can detect, the higher its sensitivity is. The basic aim of this research is to achieve a high sensitivity SOI image sensor.

Firstly, at our application the pixel size (of each pixel) is  $100\mu\text{m} \times 100\mu\text{m}$  and the active pixel area is  $100\mu\text{m} \times 1\mu\text{m}$ . So, the fill factor of this application is 1%, a ratio that is rather small. However, the performance of the matrix is not influenced badly by this fill factor as the basic aim is to detect low light intensities.

The output of each pixel is set by the delta sigma modulator. The drain current of the phototransistor is compared to the current reference that is mirrored in the delta sigma modulator of each bit line. The output is depended on this comparison. So the operation mode of the pixel matrix is based on the correct control of the current reference and the

reading voltage (which also controls the level of the drain current) of the phototransistor when there is no illumination. When the difference between the drain current and the reference current is rather small (nanoamperes) and the current reference is quite higher, the output of the pixel is high (5volts). So, when a light intensity, which can be detected by the phototransistor, illuminates the pixel matrix, it raises the drain current and as a result the output of the pixel goes low (0 volts). This is the way that the reaction of the phototransistor under illumination can be detected and its sensitivity to light intensities can be measured.

Using two green leds for light illumination, the lower and the higher sensitivity of the SOI pixel were measured. At first, a weak green led was put at the distance of 17.24mm above the matrix in order to measure the sensitivity of the matrix in the lowest light intensity. Before this, a commercial photodiode was used to measure the power intensity of the green light at the distance of 17.24mm when it is supplied with different currents. Illuminating the image sensor, it was observed that the pixels were reacting when the current of the green led was more than 0.225 mA. The corresponding irradiance that the pixel is sensitive is  $30\text{mW}/\text{m}^2$ . A stronger green led was used to measure the maximum sensitivity of the matrix. This led was placed 11mm above the matrix. According to the measurements the maximum irradiance that the pixels are sensitive is  $11380\text{mW}/\text{m}^2$ .

The measurements for the pixels' sensitivity were done in the moderate inversion of the phototransistor. The current reference of the pixels was  $8\mu\text{A}$  and the gate voltage of the phototransistor was 1.49 volts. Measurements in different operating points of the phototransistor were done, too. During them, it was observed that swinging the current reference from lower (about  $3\mu\text{A}$ ) to higher ( $12\mu\text{A}$ ) currents (and thus changing the operating point of the phototransistor) there was no variation in the lower sensitivity of the pixel matrix. However, the maximum sensitivity of the pixels was changing in different current reference, so there is the possibility to choose the desired dynamic range of the pixel matrix by setting the current reference without affecting the lower sensitivity of the pixels. It is pointed out that the pixel achieves high sensitivity thanks to the built-in Delta-sigma modulator even though the fill factor is very low. Furthermore, the outputs of the pixels were displayed in a terminal using a software solution, after passing through the microcontroller and the RS232 port.

##### B. Dynamic Range

The dynamic range is very representative of the performance of an image sensor. It is defined as:

$$\text{dynamic.range(dB)} = 10 * \log_{10} \left( \frac{\text{max power}}{\text{min power}} \right) \quad (1)$$

After measuring the maximum and the minimum irradiance that the pixel matrix can detect, the dynamic range of the matrix was measured at 25.79 dB. It is pointed out that this dynamic range is lower than the dynamic range of the modern advanced applications. However, the dynamic range of our

pixel matrix is basically dependent on the current reference of the pixel and a higher dynamic range can be achieved without reducing the sensitivity in low light intensities.

### C. Power Spectral Density

A sine modulated signal at the frequency of 10 Hz was used to test the ability of the pixel matrix to output the exact frequency of the incoming signal. The signal was supplied by a calibrated green led which was placed above the pixel matrix. The Fast Fourier Transform of the output of a rapid pixel is shown in figure 5. In order to calculate the Fast Fourier Transform, a blackmanharris window was used to add the desired data to the signal. It is shown (fig. 5) that the signal of 10 Hz is not figured accurately. Instead of being at the axis of 10 Hz, there is a shift of it at the axis of 12 Hz. This mismatching is ascribed to the operation of the Delta sigma modulator. Additionally, the form of the reading signal that controls the reading phase and the charge pumping phase and it is supplied by the microcontroller is very critical for the pixel matrix to be able to display the correct frequency of the incoming signal. The reading signal is nothing but the clock signal to the Delta sigma modulator of the pixel and the jitter effect of the clock on the modulator was studied in [7].

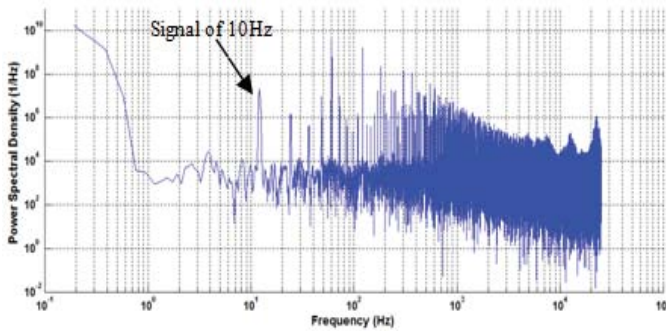

Fig. 5. The measured power spectral density of a tone of 10Hz with the window Blackmanharris.

### D. Fixed Pattern Noise

The fixed pattern noise presents how uniform is the behavior of different pixels of the matrix when they operate under the same conditions. It is pointed out that the human eye is very sensitive to small amounts of fixed pattern noise and even a ratio of 1-2% could be clearly visible for it [8].

The outputs of the pixels are binary and the light that illuminates each pixel of the matrix is qualified by the digital 0's and 1's that are collected from the end of the bit line (output of voltage image sensor). Due to the insertion of the current comparator between the phototransistor and the voltage sense amplifier, the stronger is the irradiance of the incoming light, the more the 0's at the output. In order to create a frame of a picture, it was decided to take 256 samples of the output of a pixel and to add the digits. If the sum is close to 256, this means that too many 1's are collected because there was no light on the phototransistor. Otherwise, if the sum is close to 0, the 0's at the output were too many and there was strong illumination.

The qualification of the incoming light depends on the swinging of the outputs between 0 and 1. The pixel matrix can

achieve high performance if all the pixels swing in the same tempo under common operating conditions. The fixed pattern noise is representative of this uniformity of the pixels and it is calculated when all the pixels are switching (thus outputs swing between 0 and 1) and there is no illumination on the matrix. To do the pixels swing in dark, a higher current reference was supplied to the matrix in order to be comparable to the drain current of the phototransistor and cause both high and low voltage at the bit line.

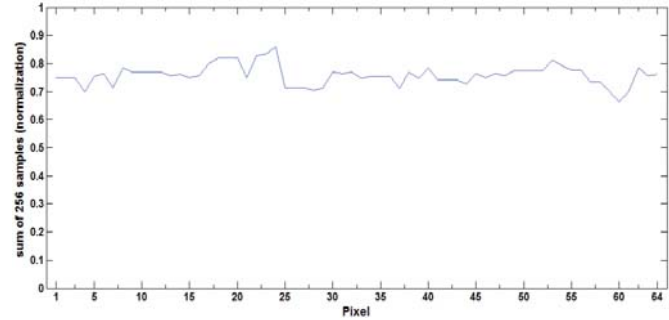

Fig. 6. Mean normalized sums of 256 samples for each pixel in dark.

The fixed pattern noise is defined as the standard deviation of the sums of 256 samples for each pixel. At this matrix, it is measured at 4.73%. In figure 6, there is a view of the aberrance between the outputs of the 64 pixels. The vertical axis of the diagram presents the normalized sum of 256 samples; the sum is divided by 256. The phototransistors operated in the moderate inversion during the measurements.

### E. Temporal Noise

The temporal noise comes from the variation between different frames and it is independent of the pixels. It is very important for the stability of an image sensor, especially for video applications. The temporal noise of each pixel is calculated by the standard deviation of the output of different frames in dark, while the temporal noise presents the aberrance in the operation of a pixel in different frames. The mean temporal noise of the whole matrix was measured at 1%. Twenty different frames of each pixel were compared in order to measure the temporal noise.

### F. Signal to Noise Ratio

Signal to noise ratio is defined as the ratio of the signal power ( $P_{\text{SIGNAL}}$ ) to the total noise power ( $P_{\text{NOISE}}$ ) that corrupts the real signal.

$$SNR(dB) = 10 \log_{10} \left( \frac{P_{\text{SIGNAL}}}{P_{\text{NOISE}}} \right) \quad (2)$$

It is very important for a digital image sensor to have stronger signal than noise in order to achieve high bit resolution of the output and to benefit from techniques that promise high sensitivity. Depending on the application, desirable values are usually higher than 20db. Analyzing the power spectral density of figure 3, the signal to noise ratio of the application is measured at 66 dB.

### G. Speed Imaging

The speed imaging is mostly depended on the clock frequency of the microcontroller. Using the external clock of 18.432 MHz in the microcontroller, the reading phase of each pixel-column lasts about 25us. So, the reading of the whole matrix lasts 200 us. In order to produce a frame of the image we need 256 samples from each pixel and thus 51.2ms. Including the time that the microcontroller needs to send the data to the terminal, a whole frame is produced in 60ms. It is pointed out that a faster clock of the microcontroller unit could increase this speed imaging, as the measurements showed that the matrix could operate accurately if the reading signal of the pixels is supplied in higher frequencies.

### H. Power Consumption

The chip for the matrix was produced for research purpose, because there was the need to test the new light sensing technique, the charge pumping pulses. So, the CMOS technology is 1 $\mu$ m and it was not considered to take into account the requirements for low voltage supply. So, the voltage supply is 5 volts. Table I shows the power consumption of the whole matrix when the phototransistor is biased to two different operation points.

Total $I_{DC}$	$I_{ref}$	Power Consumption of the matrix
17.2mA	5 $\mu$ A	6mW
17.5mA	8 $\mu$ A	7.5mW

### I. Capturing an Image

The basic characteristic of an image sensor is the ability to regenerate images as close as to the real images that illuminate the matrix. To evaluate this ability, there is the need to drive simple illuminating patterns to the matrix, collect and process the output of the matrix and finally depict it to an external terminal using a software solution.

In this implementation the output of each pixel is binary. The number of the digital 0's that are received at the output is proportional to the light that illuminates the matrix. The stronger the light on the pixel, the more are the digital 0's at its output. In order to generate an image with the image sensor, there was the decision to take 256 samples of each pixel and then to sum the digits. These sums can be between 0 and 256. If a pixel is not illuminated, the sum of the samples of its output is expected to be 256, otherwise less. A strongly illuminated pixel is expected to have a sum near 0. So, the sum of the samples of one pixel is representative of the light that illuminates it. The pixel matrix was illuminated in different parts of it in order to observe the behavior of the pixels, the columns and the rows of the matrix under different illuminating patterns. The illuminating pattern was shifting from the left part of the matrix to the right during the measurements. Four different frames, which were captured by the matrix, are presented in figure 7. It is pointed out that the fixed pattern noise was subtracted from the images with a software solution. The images are regenerated in a gray scale

of 256 colors, which corresponds with the range of values of the calculated sums. So, if a pixel is displayed by a dark tone, this means either that the incoming light on the phototransistor was not strong or that there was no incoming light.

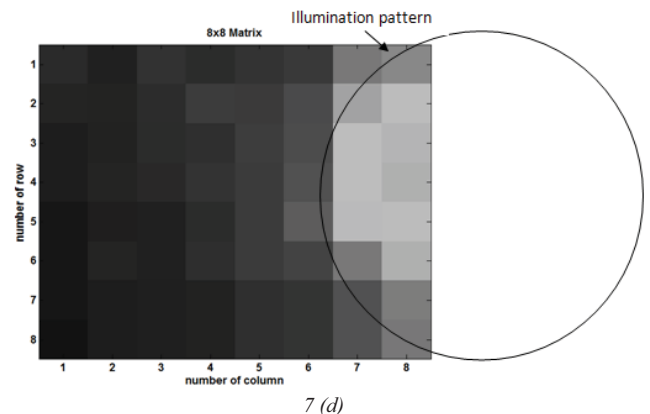
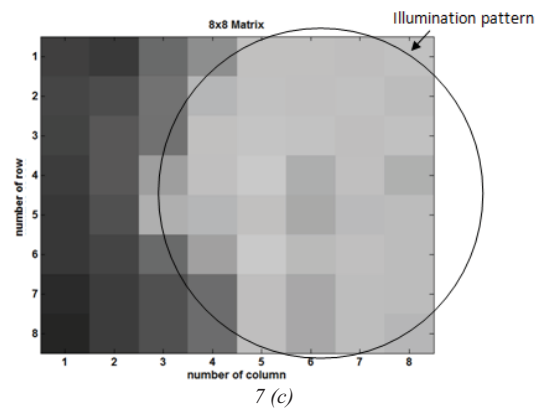
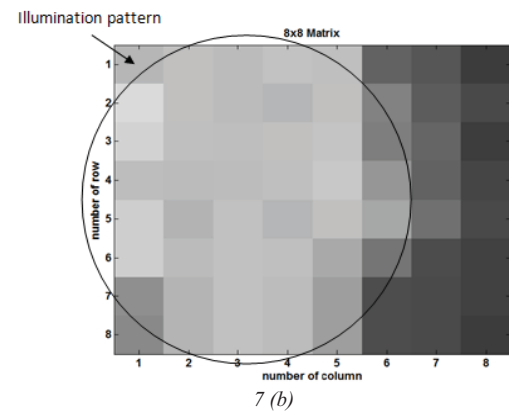
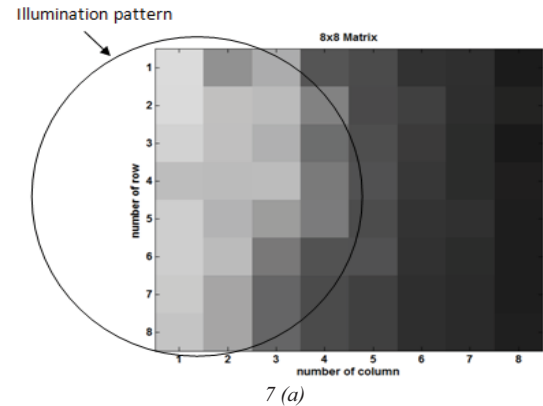

Fig. 7. Captured images when illuminating different parts of the matrix.

Observing the generated images, it is shown that the outputs of the pixels follow the illumination pattern and the whole matrix has the desirable operation. Also, subtracting the fixed pattern noise, no high pattern noise is observed between columns and rows of the matrix.

## V. CONCLUSION

The performance evaluation of a SOI pixel matrix has been presented in this paper. The design of the pixel driver and the read out circuit using the new light sensing technique of charge pumping has been described in [1]. A measurement set-up has been developed in order to estimate the characteristics of the fabricated 8x8 pixel matrix. Images produced under spotlight illumination on the sensor are given in figure 7, showing its effective operation. A summary of its basic characteristics is presented in Table II.

TABLE II  
SUMMARY OF PIXEL MATRIX CHARACTERISTICS

Technology	1 $\mu$ m SOI MOS
Pixel Size	100 $\mu$ m x 100 $\mu$ m
Supply voltage	5 volts
Fill Factor	1%
Dynamic Range	25.79dB
Sensitivity(min)	30mW/m <sup>2</sup>
Maximum Irradiance	11380mW/m <sup>2</sup>
Fixed Pattern Noise	4.73%
Temporal noise	0.75%
Power Consumption	6mW
SNR	66dB
Frame rate	16.7 frames/sec

The measurements are now focused on preliminary trials to increase the operating frequency of the image sensor and the results seem to be promising. It would be useful to exploit the performance of the sensor in video applications, although the bulk CMOS technology has achieved very high goals in that field.

## REFERENCES

- [1] L. Harik, J-M. Sallese and M. Kayal, "Transient charge pumping as an efficient technique to measure low light intensity with PD SOI MOSFET," in *Solid-State Electronics*, Vol. 52, May 2008, pp 597-605.
- [2] J M Hill and J. Lachman, "A 900 MHz 2.25 MB cache with on chip CPU now in CU SOI" in *ISSCC 2001, Session 11 SRAM* 11.5.
- [3] M. Blagosevic, M. Kayal, M. Pastre, L. Harik, M.J. Declercq, S.Okhonin, P.C.Fazan, "Capacitorless, 1T DRAM sensing scheme with automatic reference generation", in *Solid-State Circuits, IEEE Journal of*, vol.41, no.6, pp. 1463-1470, June 2006.
- [4] L. Harik, J-M. Sallese, M. Kayal "Transient Charge Pumping as a New technique for a Higher Sensitivity SOI MOSFET Photodetector," European Solid-State Device Research Conference ESSDERC 2007, Munich -Germany, pp 366-369.
- [5] E. Culurciello, "Three dimensional Phototransistors in 3D Silicon-On-Insulator technology", in *IET Electronics Letters*, vol.43, issue 7 29<sup>th</sup> March 2007, pp418-420.
- [6] E. Culurciello and P. Weerakoon, " Three-Dimensional Photodetectors in 3D Silicon-On-Insulator technology", in *IEEE Electron Device Letters*, vol. 28, issue 2, February 2007, pp 117-119.

- [7] L. Harik, J-M. Sallese and M. Kayal, "Delta-Sigma Loop Based on Charge Pumping in SOI Optical Sensor," *IEEE Sensors* 2008. October 2008 Lecce Italy, pp 1382-1385.
- [8] Shigehiro Miyatake, Masaru Miyamoto, Koichi Ishida, Takashi Morimoto, Yasuo Masaki and Hideki Tanabe. "Transversal-Readout Architecture for CMOS Active Pixel Image Sensors. *IEEE Transactions on electron devices*, Vol.50, No 1, January 2003.

**Maher Kayal** Maher Kayal received the M.S. and Ph.D. degrees in electrical engineering from the Ecole Polytechnique Fédérale de Lausanne (EPFL, Switzerland) in 1983 and 1989 respectively. He has been with the Electronics laboratories of the Ecole Polytechnique Fédérale de Lausanne (EPFL, Switzerland) since 1990, where he is currently a professor and vice dean for education of the school of engineering. He has published many scientific papers, coauthor of three text books dedicated to mixed-mode CMOS design and he holds seven patents. His technical contributions have been in the area of analog and Mixed-signal circuits design including highly linear and tunable sensors microsystems, signal processing and CAD tools for Analog design and layout automation. M. Kayal is a recipient of the Swiss Ascom award in 1990 for the best work in telecommunication fields; He is Author and co-author of the following paper award in: ED&TC conference in 1997, IEEE-AQTR in 2006, Mixdes conference in 2007 & 2009, Power tech conference in 2009. M. Kayal receive in 2009 the Swiss credit award for best teaching.

**Jean-Michel Sallese** Jean-Michel Sallese received the MSc degree from the Institut National des Sciences Appliquées (France) and the Ph.D. in physics from the University/CNRS of Nice-Sophia Antipolis (France) where he worked on deep levels characterization in semiconductors. He joined the Swiss Federal Institute of Technology in Lausanne (EPFL) in 1991 where he worked on semiconductor laser diodes characterization and modeling. He is currently giving lectures on advanced semiconductor devices as and his research activities focus on compact modeling of multigate MOSFET's as well as modeling of Micro-Electro-Mechanical Systems.

**Louis Harik** Louis Harik (M'03) received the B.E. and M.E. degrees in computer and communications engineering from the American University of Beirut, Lebanon, in 1999 and 2003, respectively. He earned his Ph.D. degree at the Ecole Polytechnique Fédérale de Lausanne, Switzerland in 2009. His research interests include mixed-signal circuit design, SOI photosensors, optoelectronics and image sensors.

**Alkis A. Hatzopoulos** Prof. Alkis A. Hatzopoulos was born in Thessaloniki, Greece.

He received his Degree in Physics (with honours), his Master Degree in Electronics and his Ph.D. Degree in Electrical Engineering from the Aristotle University of Thessaloniki, Greece, in 1980, 1983 and 1989 respectively. He was a research associate in the Department of Electrical and Computer Engineering at the Aristotle University of Thessaloniki for seven years and in 1989 he was elected as a Lecturer. Currently, he is a professor at the same Department and also the Director of the Electronics Laboratory.

Prof. Hatzopoulos is a member of the Greek Physics Society and the Greek Computer Society. He is also a senior member of IEEE. He is actively involved in educational and research projects and he is the author or co-author of more than 110 scientific papers in international journals and conference proceedings.

His research interests include: design and fault diagnosis of integrated circuits and systems (analog, mixed-signal, RF), electronic communication circuits, instrumentation electronics.

**Dimitrios H. Ntavelis** Dimitrios Ntavelis was born in Thessaloniki, Greece. He has got his Diploma in Engineering from the Department of Electrical and Computer Engineering at the Aristotle University of Thessaloniki, Greece. His research interests include analog integrated circuits and SOI photosensors.