

# Remarks on aerodynamic forces in seals of turbine stages

Robert Stępień,  
Krzysztof Kosowski

## Abstract

This paper presents results of numerical examination of flow through over-shroud seals of turbine stages. Various labyrinth seals of different configurations and number of sealing teeth were considered. It was demonstrated that results of investigations of isolated seals cannot be directly used for analyzing turbine stage operation. Such approach may lead to relatively large errors in determining value of aerodynamic force and direction of its action.

**Keywords:** rotor dynamics, self-excited vibrations, aerodynamic forces, blade seals, turbine shrouds

## Introduction

Turbine rotor often moves along a complex trajectory during operation, usually it is displaced by the eccentricity  $e$  relative to turbine cylinder centre, it changes its longitudinal position  $a$ , and its axis can be situated aslant relative to cylinder axis, forming with it the angle  $\varphi$  (Fig.1). This results in circumferential and axial change of clearance in turbine stage seals (over-shroud ones as well as external glands), that in turn causes that distribution of flow both in seals and grids of blades becomes no longer circularly symmetrical. Unbalanced aerodynamic forces appear (called blade-ring forces if occur in passages of grid of blades, and pressure forces if in seals). The forces can lead to self-excited vibrations of turbine rotors and -in some cases -prevent turbine from developing its rated power.

For more than fifty years the phenomenon has been investigated in many research centres worldwide. Many results of experimental, theoretical and numerical investigations have been so far published. In the beginning, analyses based on the so called „bulk-flow theory” have been developed ([11]-[13], [15]). In the method, simplifications are implemented in solving three-dimensional, non-stationary equations of flow through the clearance, consisting in linear association of shear stresses on the walls with average flow velocity (that is only possible at rather small rotor displacements against casing). This way flow behaviour equations

were simplified to 2<sup>nd</sup> order ones as well as it was made possible to consider the flow to be axially symmetrical and stationary and that in which only small disturbances described by linear relations occur. As a result of solving such set of equations distributions of velocity and pressure fields in the clearance are achieved; they are then used for determining forces and moments generated in the clearance. The end of the 1980s and the 1990s brought development of computer calculation techniques used also in the modelling of flows through the clearance between rotor and casing, as well as in the determining of dynamic coefficients for such systems. The simulations are based on three-dimensional Navier-Stokes equations with Reynolds averaging (RANS), closed by means of the  $k$ - $\epsilon$  turbulence model. For calculations algorithms based on the methods of finite elements [7], finite differences [9], [14], [17], [18] and finite volumes [1]-[6], [8], [10], are used. Analysis of forces generated in isolated seals is only of a limited usefulness for design practice. Flows through seal are also influenced by phenomena which occur both in passages of vane blades and rotor blades grids. Therefore results obtained from investigations of isolated seals cannot be directly applied to analysis of operation of a complete turbine stage.

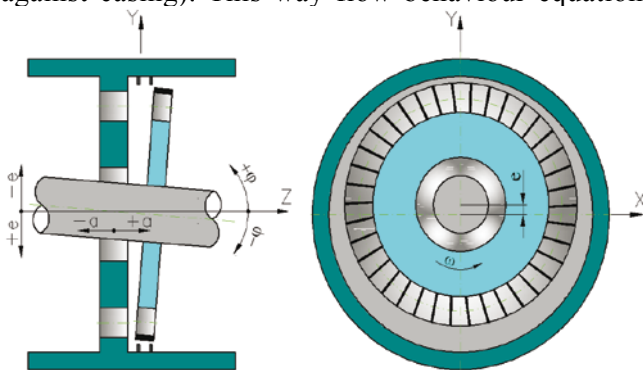

Fig. 1 Changes in position of rotor against casing,  $a$  – change of axial clearance,  $e$  - eccentricity,  $\varphi$  - angle of aslant displacement of rotor axis against casing axis

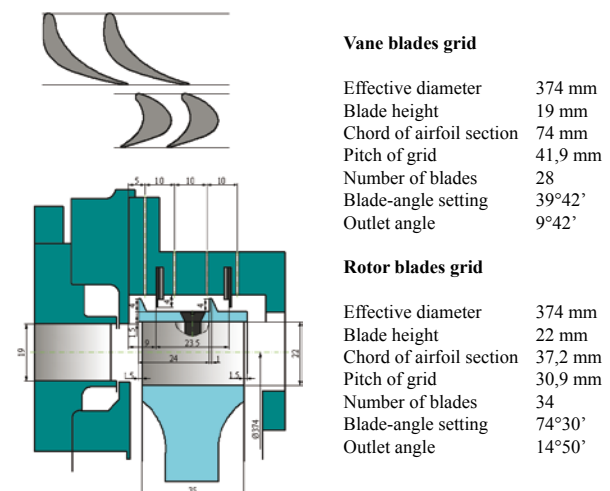

Fig. 2 Vane-blade and rotor-blade profiles as well as scheme of turbine stage flow part

## Object of the investigations – a turbine stage

The schematic diagram of the flow part of the investigated turbine stage is shown in Fig. 2. Three-dimensional flow analysis of the investigated turbine stage was performed by means of the CFD Fluent code in which the method of finite volumes is used for solving the set of Navier-Stokes equations. The calculations were performed for compressive, viscous (with constant viscosity coefficient) and turbulent flow without any heat exchange with environment. Geometry of the turbine flow part (Fig.2) was modeled by means of a computational mesh split into four blocks: inlet to the stage together with guide vanes, rotor, over-shroud seal, and outlet diffuser, which are so connected to each other as to form one computational entity (the applied kind of computational mesh and interfaces between particular blocks are described in detail in [16]).

All the flow calculations were performed for the nominal clearance  $L = 0.5$  mm and the eccentricity  $ew = 60\%$  (vertical).

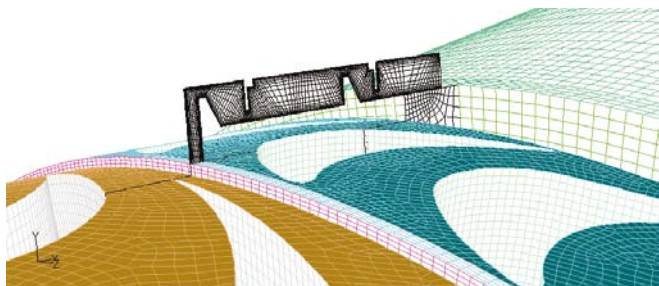

Fig. 3 Example of computational mesh of turbine stage flow part

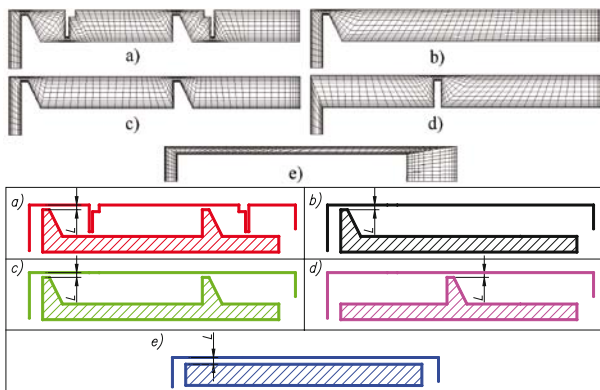

Fig. 4 Schemes and meshes of the investigated seals as follows: a) with 4 teeth (marked U4), b) with single tooth at inlet (marked U1), c) with 2 teeth (marked U2), d) with single tooth in the middle of shroud (marked U1s), e) smooth one – without teeth (marked U0)

In Fig. 3 an example of the applied computational mesh is presented, and in Fig. 4 are shown schemes, notations and computational meshes of the considered over-shroud seals, namely:

- the seal with 4 teeth (marked U4),
- the seal with single tooth at inlet (marked U1),
- the seal with 2 teeth (marked U2),
- the seal with single tooth in the middle of shroud (marked U1s),
- the smooth seal, i.e. without teeth (marked U0)

## Influence of type of seal on pressure forces

To investigate influence of geometry of an isolated seal on forces generated in it, a simplified computational model was elaborated; in the model guide vanes were replaced with a smooth pipe and rotor blades grid was omitted. Fig. 5 shows cross-section through the upper part of the computational system geometry. The calculations were carried out for the constant value of working medium overpressure of at inlet to the pipe, equal to 5kPa. This value is equivalent (roughly) to the pressure at inlet to the seal (after expansion in guide vane), which occurs in the case of analysis of flow through the real turbine stage operating with the rotor angular frequency of 566 rad/s and the inlet overpressure of 20kPa.

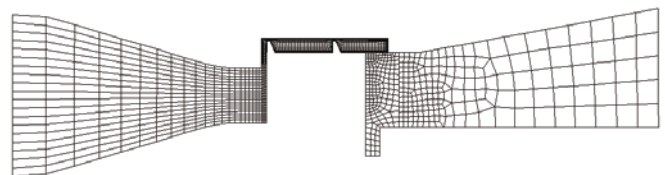

Fig. 5 Cross-section through geometrical model of 'isolated' seal

The run of pressure in the investigated seals along shroud breadth is shown in Fig. 6, and the pressure fields in the lower cross-section of seal, (D), and the upper one (G) – in Fig. 7. All the presented characteristics are in compliance with the Lomakin effect [5] according to which at inlet to unsymmetrical clearance the maximum pressure value occurs in the place where the lowest clearance value

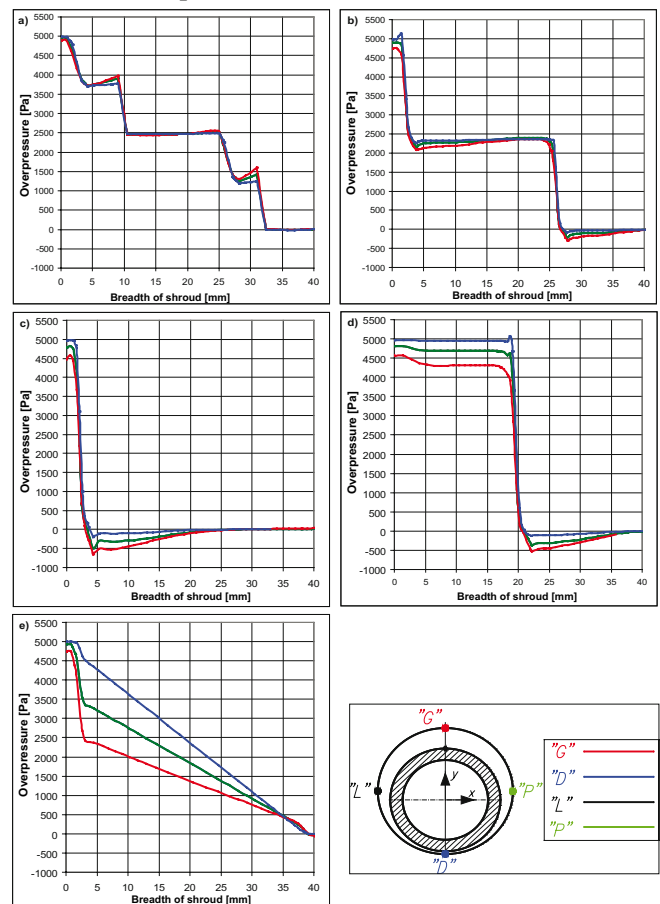

Fig. 6 Pressure distribution along shroud breadth in the following seals: a) U4, b) U2, c) U1, d) U1s, e) U0, (f – arrangement of the cross-sections along seal circumference)

appears (cross-section D), and the minimum pressure value – in the place where the maximum clearance value appears (cross-section G). The resulting pressure difference causes the force acting in opposite direction to eccentricity, called also righting force, to appear. In the plane perpendicular to that direction the pressure distributions on both sides of the examined seal (cross-sections: L and P in Fig. 6f) are symmetrical, therefore no horizontal component of the resultant force appears.

Also, velocity fields in the analyzed cross-sections of the seal appear to be different respectively. Velocity of working medium flowing through the seal reaches its maximum value in the place where the maximum clearance occurs (cross-section G), and its minimum value where the minimum clearance occurs (cross-section D). Direction of the flow is axial. The pathlines of the working medium flow through the seal U0 are presented in Fig. 8. Red colour of the presented lines, which appears in the upper part of the seal, stands for the maximum flow velocity of working medium. For the sake of clarity, the flow through inlet pipe as well as

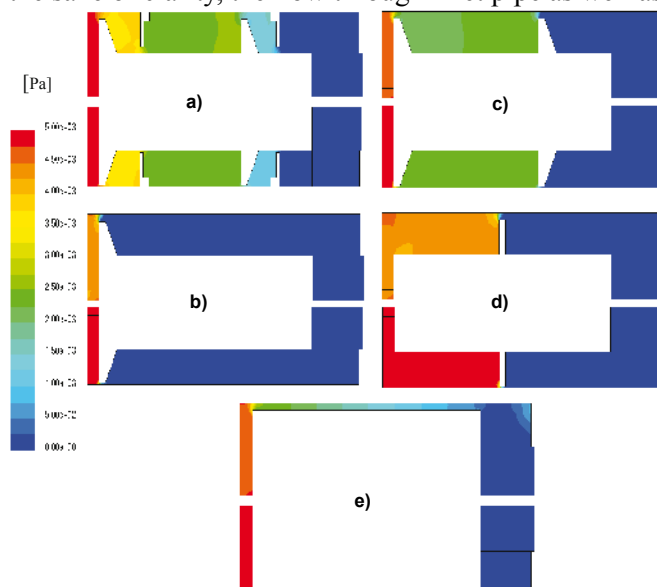

Fig. 7 Pressure field in the upper cross-section G (of maximum clearance) and lower cross-section D (of minimum clearance) of the following seals: a) U4, b) U2, c) U1, d) U1s, e) U0

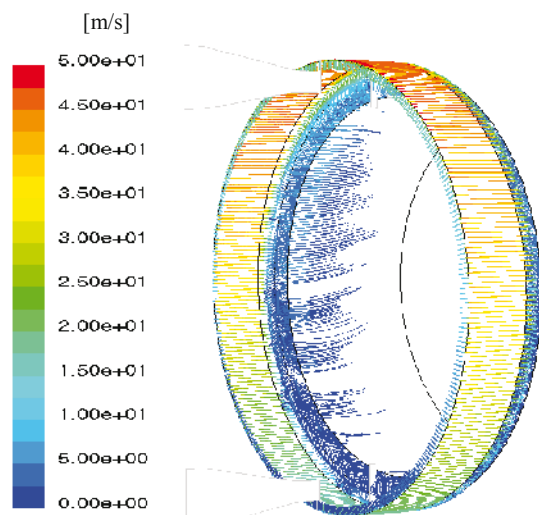

Fig. 8 Pathlines of the working medium flowing through the seal U0

pathlines in outlet diffuser have been omitted in the figure.

Analyzing the obtained results one can conclude that type of applied seal decisively influences distribution of pressure field occurring in its clearance, consequently also pressure forces generated in it. In the same boundary conditions, values of the forces in particular seals differ several times or even a dozen or so times, to each other (Fig. 9).

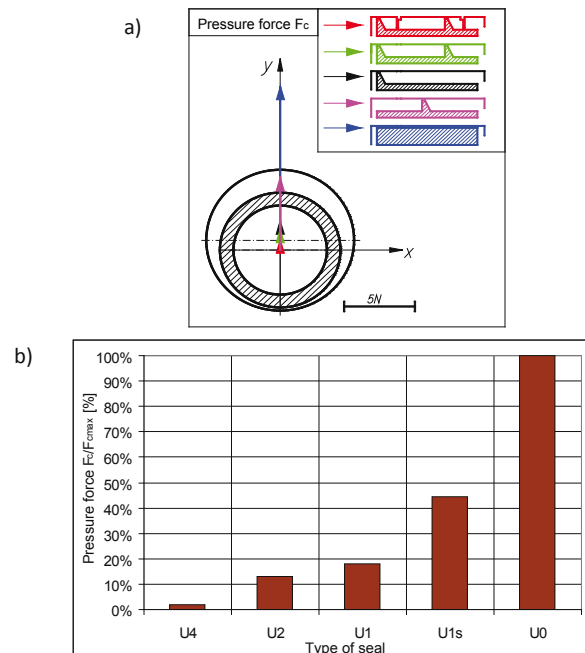
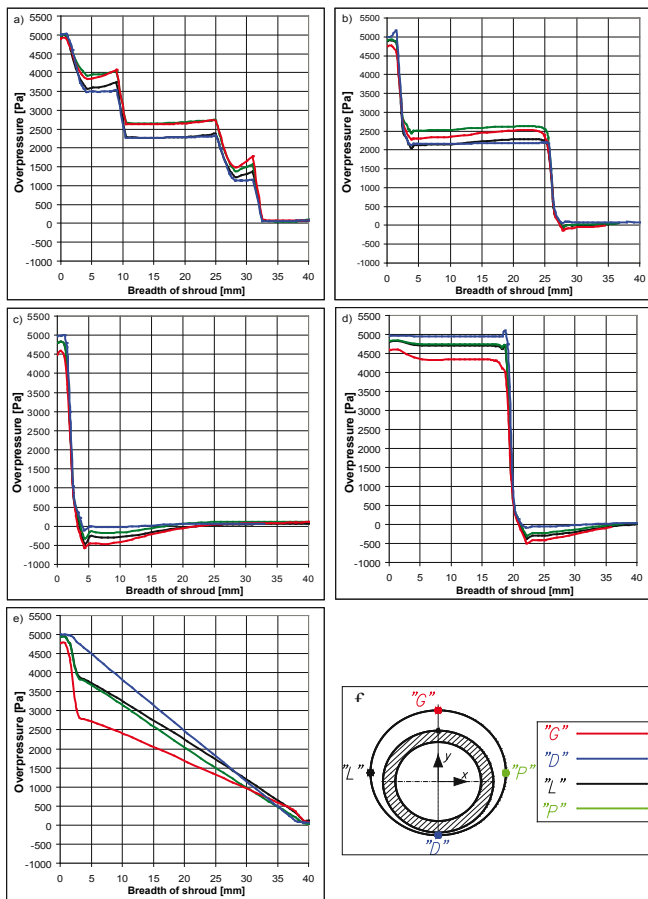

Fig. 9 Vectors, (a), and values, (b), of the pressure force  $F_c$ , occurring in the investigated seals (the force values are related to that which occurs in the seal U0) (red colour stands for the seal U4, green colour – the seal U2, black colour – the seal U1, violet colour – the seal U1s, blue colour – the seal U0)

The Lomakin effect is observed in the cases in which shroud is motionless or working medium non-viscous. For viscous working medium and rotating shroud viscosity forces make pressure field in the seal clearance and location of its extremes, changing. Pressure distributions in the plane perpendicular to eccentric displacement, on both sides of the seal (cross-sections: L and P), become no longer symmetrical, and, as a result, a force vector deviation from direction of eccentric displacement of rotor occurs. The pressure field distribution in the considered seals, for the case of viscous working medium and shroud rotating with the frequency of 566 rad/s, is presented in Fig. 10, and in Fig. 11 – the vectors and values of the calculated pressure forces.

The greatest deviation of vector of generated forces, resulting from shroud wall rotation, occurs in the seals characterized by greater number of teeth (U2 and U4 type). Moreover, in the seals friction effects due to motion cause a significant increase of generated pressure forces. For instance, in the seal of four teeth, U4, the force is increased almost ten times. In the remaining seals, smooth one, U0, and that of single tooth, U1, values of the forces do not undergo so significant changes as those observed in the motionless seal system. Even a small decrease of the force  $F_c$  was observed in the seals of U1s and U0 type.



**Fig. 10** Pressure distribution in the seals along shroud breadth for viscous working medium and the shroud angular frequency equal to 566 rad/s: a) U4, b) U2, c) U1, d) U1s, e) U0 (f – arrangement of the cross-sections along seal circumference)

In Fig. 12 flow through the four-teeth seal U4 is compared for the variants: when the seal shroud is motionless and when it rotates. In the latter case the flow through over-shroud clearance is no longer only axially directed because circumferential velocity components due to viscosity forces, appear.

From additional numerical analyses of non-viscous flow through the examined seals no deviation of the direction of action of pressure forces from the eccentricity direction, resulting from shroud rotatory motion, was stated. Character of pressure field distribution in the seal as well as values of generated forces were in compliance with results of the analyses in the case of motionless shroud wall.

### Forces in the turbine stage with seals of various types

Numerical investigations of operation of the turbine of 7.5kW output power at the angular frequency of 566 rad/s (at 20kPa inlet working medium overpressure) were performed in order to make comparative analysis and determine resultant forces acting on the rotor in the real turbine stage fitted with labyrinth over-shroud seals of various types. Fig. 13 presents pressure distributions on the shroud of the examined seals, and Fig. 14 -vectors of the pressure forces FC, blade-ring forces FW and resultant force FP, acting on the rotor. As values of the

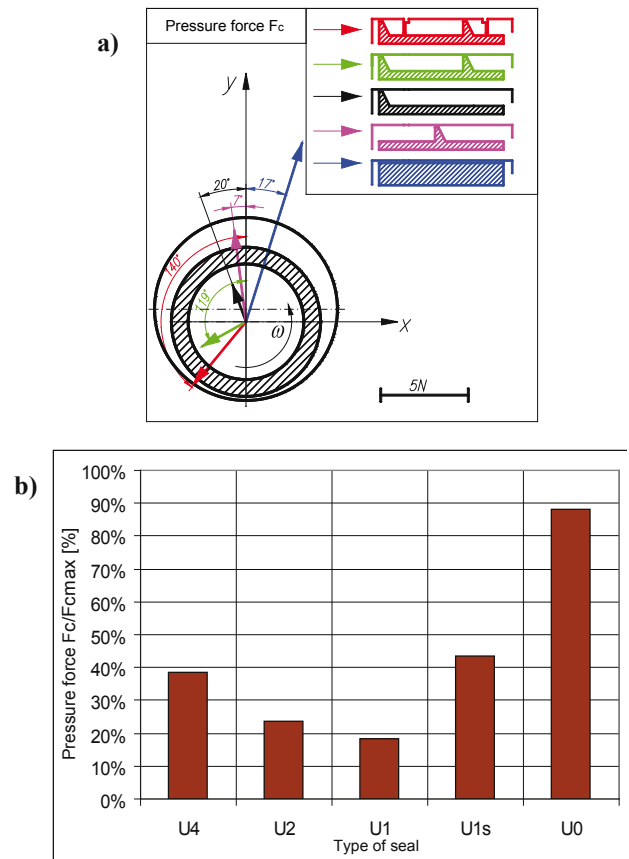

**Fig. 11** Vectors, (a), and values, (b), of the pressure force FC occurring in the investigated seals for viscous working medium and the shroud wall angular frequency equal to 566 rad/s (the force values are related to that which occurs in the U0 seal of motionless shroud)

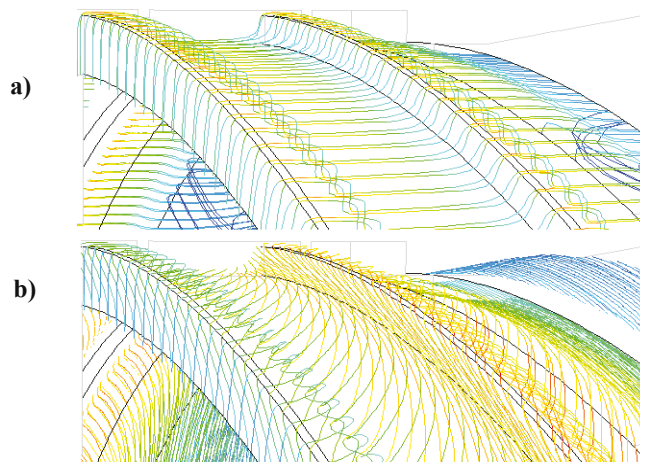

**Fig. 12** Pathlines of viscous working medium flowing through the seal U4: (a) in the case of motionless shroud, (b) in the case of rotating shroud with the angular frequency equal to 566 rad/s

blade-ring forces are small they are shown in five times greater scale than the remaining – pressure and resultant ones.

In Fig.15 are presented the values of the forces calculated for the investigated seals, related to the value of the resultant force FP occurring in the two-teeth seal U2. Blade-ring forces are marked blue, pressure forces – brown, and resultant force acting on turbine rotor – yellow.

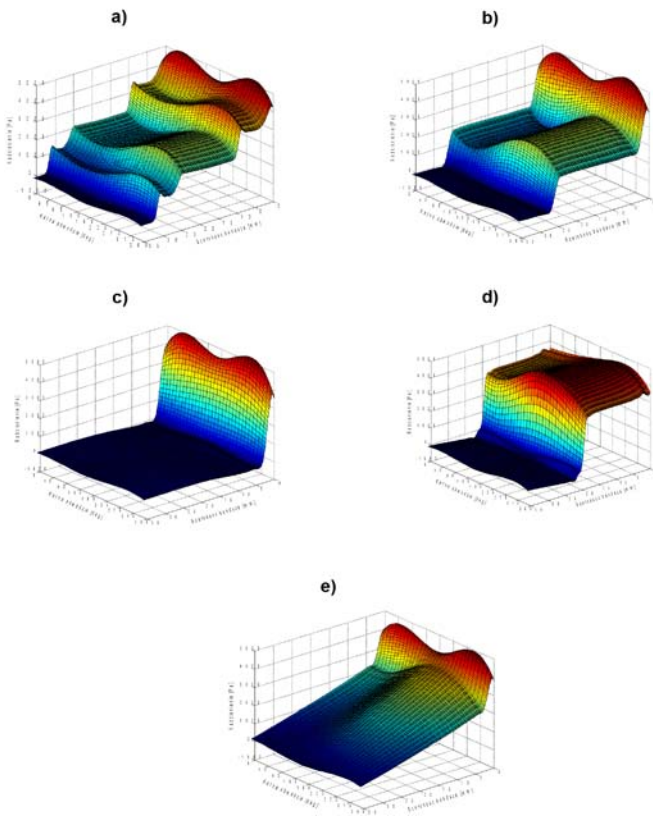

**Fig. 13** Pressure distribution in the seals: **a)** U4, **b)** U2, **c)** U1, **d)** U1s, **e)** U0 -for 20kPa working medium overpressure at inlet to turbine stage, and the rotor angular frequency equal to 566 rad/s

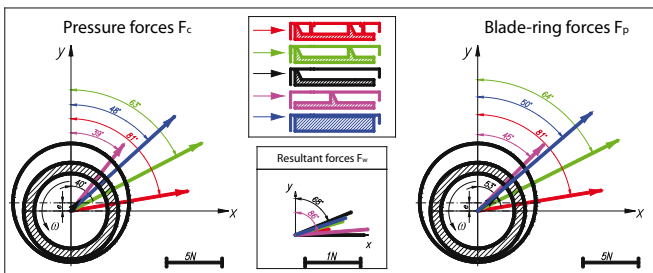

**Fig. 14** Vectors of: the pressure force  $F_c$  (on the left), blade-ring force  $F_w$  (in the middle) and resultant force  $F_p$  (on the right), acting on the rotor, for the model IV at 20kPa inlet overpressure and the rotor angular frequency of 566 rad/s (red colour stands for the seal U4, green – the seal U2, black– the seal U1, violet– the seal U1s, blue– the seal U0)

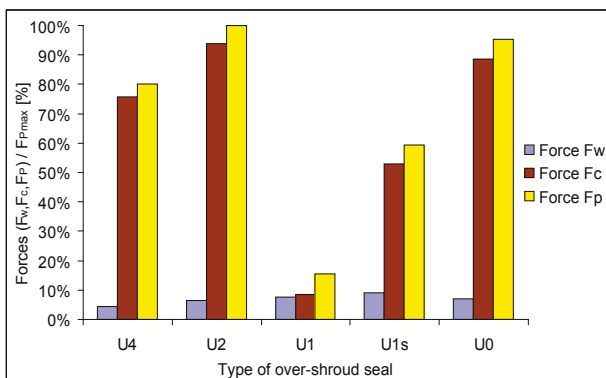

**Fig. 15** Values of the blade-ring forces  $F_w$  (blue), pressure forces  $F_c$  (brown), resultant force  $F_p$  (yellow), at 20kPa inlet overpressure and 566 rad/s rotor angular frequency

Analyzing the obtained results one can state that influence of seal design on blade-ring forces generated

in rotor passages is small (comp. Fig.14 and Fig.15). For all the examined systems generated blade-ring forces are of comparably small values regardless of type of applied seal.

Type of over-shroud seal decisively influences pressure forces generated in it. As results from analysis of the diagrams shown in Fig. 13, working medium pressure at inlet to and outlet from the seal is almost of the same value for all the compared systems, and it has been determined by values of the turbine stage operational parameters and eccentricity value. However type of over-shroud seal decisively influences pressure field distribution in its clearance (between inlet and outlet), and consequently pressure forces generated in it.

As it turned out, the smallest pressure forces (Fig.15) occurred in the seal of single tooth placed at inlet to the seal U1 and were nine times smaller than those in the seal U2 of two teeth, and over seven times smaller than those in the seal U4 of four teeth. This results from a favourable pressure distribution occurring in the clearance, determined by the conditions prevailing behind the rotor blade ring, and which is levelled out to a constant value over whole breadth of the shroud. Therefore no large circumferential differences in pressure appear (in contrast to the seals of a few teeth), and the generated forces are relatively small.

It should be also observed that the pressure forces obtained in the real turbine stage differ from those generated in the isolated seals, i.e. without taking into account other elements of turbine stage. In the case of isolated seals the largest forces occurred in the smooth seal, U0, as well as that of single tooth placed in the middle, U1s. In the real turbine stage the largest forces are generated in the seal of two teeth, U2, the seal of smooth shroud, U0, as well as the seal of four teeth, U4. In all the performed analyses the seal of single tooth at inlet to the clearance, U1, appeared to be characterized by the smallest pressure forces.

However it should be taken into consideration that the lowering of number of teeth in over-shroud

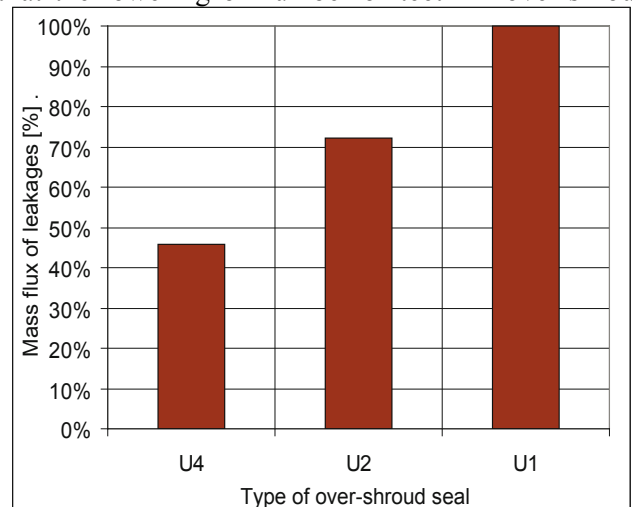

**Fig. 16** Mass flux of leakages flowing through the seal U4, U2 and U1 at the rotor angular frequency of 566 rad/s and 20kPa overpressure of working medium at inlet (the values are related to the mass of leakage from the single-tooth seal U1)

seal, favourable due to smaller values of generated aerodynamic forces, leads to the increasing of leak flux of medium flowing through seal clearance and in consequence to the lowering of total turbine stage efficiency, in the clearance. The working medium mass fluxes in the seal related to the largest leakage occurring in the single-tooth seal U1, are shown in Fig. 16. From the efficiency point of view the most favourable appears the four-teeth seal U4 which simultaneously - as results from the performed investigations - is, apart from that of two teeth, U2, the least favourable from the point of view of generation of pressure forces in it, which are able to trigger self-excited vibrations of rotor. Direction of action of generated pressure forces depends - as results from the previously performed investigations - a.o. on type of seal and number of teeth applied in it. For single-tooth seals (of U1 and U1s type) directions of action of pressure forces amount to about 38°, counting from eccentricity direction (Fig. 14). However for the two-teeth seal U2 such deviation from eccentricity direction amounts to 63°, and for the four-teeth seal U4 – as much as 80°. The smaller number of teeth in the seal the less deviated direction of action of pressure force from eccentricity, however the conclusion does not concern the smooth-shroud seal U0 because of another mode of expansion of working medium in a long and narrow clearance.

### Summary

From analysis of the obtained results the following conclusions can be drawn:

- The making use of force coefficients for isolated seals without taking into account the remaining elements of turbine stage can lead to very large errors in determining aerodynamic forces occurring in a real device. Therefore the coefficients determined for isolated seals should not be used in analyzing operation of a turbine stage.
- For all the considered seals, direction of action of pressure force in the systems in which influence of working medium expansion in rotor blades grid or guide vanes has been not taken into account, is significantly different (even by 180°) from direction of action of pressure force in a real turbine stage.
- For all the analyzed systems, pressure distributions in the planes perpendicular to turbine axis, at inlet to and outlet from seal clearance, are similar and determined a.o. by assumed boundary conditions, nominal clearance and eccentricity of the system. To a much lower extent they depend on design type of applied seal which decisively influences distribution of pressure field in its interior.

The results presented in this paper are obtained from numerical calculations, however they have been confirmed by results of the investigations carried out on experimental stand.

### Bibliography

1. Arghir M., Frêne J.: Rotordynamic Coefficients of Circumferentially-Grooved Liquid Seals Using the Averaged Navier-Stockes Equations. Transactions of the ASME Journal of Tribology, Vol 119, July 1997
2. Arghir M., Frêne J.: Analysis of a Test Case for Annular Seal Flows. Transactions of the ASME Journal of Tribology, Vol 119, July 1997
3. Arghir M., Frêne J.: Forces and Moments Due to Misalignment Vibrations in Annular Liquid Seals Using the Averaged Navier-Stockes Equations. Transactions of the ASME Journal of Tribology, Vol 119, April 1997
4. Arghir M., Frêne J.: A Quasi-Two-Dimensional Method for the Rotordynamic Analysis of Centered Labyrinth Liquid Seals. Transactions of the ASME Journal of Engineering for Gas Turbines and Power, January 1999
5. Arghir M., Defaye C., Frêne J.: The Lomakin Effect in Annular Gas Seals under Choked Flow Conditions. ASME paper GT2006-91151, Proceedings of ASME Turbo Expo, Barcelona, Spain, May 8-11 2006
6. Arghir Mihai, Mathieu Hélène, Jean Frene: Analysis of Tangential-Against-Rotation Injection Lomakin Bearings. Transactions of the ASME Journal of Engineering for Gas Turbines and Power, Vol. 127, p. 781-790, October 2005
7. Baskharone E. A., Hensel S. J.: Interrelated Rotordynamic Effects of Cylindrical and Conical Whirl of Annular Seal Rotors. Transactions of the ASME Journal of Tribology, Vol 113, July 1992
8. Chew J.W., Guardino C.: Simulation of flow and heat transfer in the tip region of a brush seal. International Journal of Heat and Fluid Flow 25, p.649–658, 2004
9. Dietzen F. J., Nordmann R.: Calculating Rotordynamic Coefficients of Seals by Finite Difference Techniques. Transactions of the ASME Journal of Turbomachinery, Vol 109, July 1987
10. Guo Z., Rhode D. L., Davis F. M.: Computed Eccentricity Effects on Turbine Rim Seals at Engine Conditions with a Mainstream. Transactions of the ASME Journal of Turbomachinery, Vol 118, January 1996
11. Hsu Y., Brennen C.: Fluid Flow Equations for Rotordynamic Flows in Seals and Leakage Paths. Transactions of the ASME Journal of Turbomachinery, Vol. 124, March 2002;
12. Lindsey Todd W., Childs D. W.: The Effect on Converging and Diverging Axial Taper on the Rotordynamic Coefficients of Liquid Annular Pressure Seals: Theory Versus Experiment. Transactions of the ASME Journal of Vibrations and Acoustics, April 2000
13. Marquette O. R., Childs D. W., San Andres L.: Eccentricity Effects on the Rotordynamic Coefficients of Plain Annular Seals: Theory Versus Experiment. Transactions of the ASME Journal of Tribology, Vol 119, July 1997
14. Rhode D. L., Hensel S. J., Guidry M. J.: Labyrinth Seal Rotordynamic Forces Using a Three-Dimensional Navier-Stockes Code. Transactions of the ASME Journal of Turbomachinery, Vol 114,
15. San Andrés L., Soulas T.: A Bulk-Flow Model Of Angles Injection Lomakin Bearings. Proceeding of ASME Turbo Expo, GT-2002-30287, June 2002
16. Stepień R., Kosowski K., Piwowarski M., Badur J.: Numerical and Experimental Investigations into Pressure Field in Blade Shroud Clearance, Part II: Numerical Analysis. Task Quarterly, 2003
17. Tam L. T., Przekwas A. J., Muszynska A., Hendricks R. C., Braun M. J., Mullen R. L.: Numerical and Analytical Study of Fluid Dynamic Forces in Seals and Bearings. Transactions of the ASME Journal of Vibration, Acoustic, Stress, and Reliability in Design, Vol 110, July 1988
18. Williams M., Chen W. C., Baché G., Eastland A.: An Analysis Methodology for Internal Flow Swirling Flow Systems with a Rotating Wall. Transactions of the ASME Journal of Turbomachinery, Vol 113, January 1991