

Optimization of steam cycles with respect to supercritical parameters

Marian Piwowarski.

Abstract

This paper contains an analysis of supercritical power stations have been presently built worldwide. The analysis concerns cycles with single and double interstage superheating and, additionally, with regenerative feed water preheating system equipped with six, seven, eight, nine and ten regenerative heat exchangers, respectively. Relevant calculations were performed for various values of fresh steam temperature and pressure, various pressure values of secondary superheating, as well as with value of condenser internal pressure maintained constant. The calculations show that to increase efficiency of steam cycle with double interstage superheating and extended regeneration even to a value greater than 51%, is possible. In the age of greater and greater demand for electric power and stronger and stronger limitations imposed on emission of noxious compounds to the atmosphere, the developing of power production technologies based on supercritical parameters seems inevitable.

Keywords: analysis of supercritical power stations, optimization of steam cycles, supercritical parameters, concerns cycles.

Description of supercritical power stations

Investigations on the increasing of efficiency of steam turbine cycle have been carried out by many research centres of universities and turbine production concerns already for a few dozen of years. In the case of thermodynamic cycles with applied steam turbines the investigations have dealt with steam pressure and temperature values greater than: the 22.12MPa critical pressure and 647.28K critical temperature, respectively. Over the critical point the difference between liquid phase and gas phase disappears [20], [25], [43]. Already in the 1950s the first attempts to developing the turbine power units based on supercritical parameters have been made. In 1957 the first in the world turbine power unit of supercritical parameters was put in motion in the electric power station, Philo, USA. The unit of 314bar/621°C steam parameters developed 125MW output power. Two years later 325MW power unit of even higher steam parameters (345bar/649°C/566°C/566°C) was built in the Eddystone I electric power station. For the high values of steam parameters special materials suitable to work in high temperatures were required. High investment cost, inadequate quality of materials, faults in assembling and operational problems forced the producers to resign from building the units for so high steam parameters. As late as in 1969 the unit designed for the supercritical parameters with double secondary superheating of 241bar/538°C/552°C/566°C, was set working. The application of such solution to the steam cycle has improved operation of the unit. Therefore in the 1970s, apart from the units with single superheating of 241bar/538/538°C steam parameters, were built the units with double superheating, which developed output power reaching from 350 do 1100 MW. Progress in material technology, started in the 1980s, has made it possible to apply higher steam parameters (310bar/593°C/593°C/593°C) to steam cycle. The application of better and better materials suitable for very high operational temperatures makes it possible to build the units for the supercritical parameters as well as ultrasupercritical ones (400bar/760°C). Modern 3-D calculation programs used in designing fluid flow

systems as well as highly efficient devices included into equipment of such units have guaranteed to achieve their high reliability and efficiency. In the 1960÷1990s in USA 159 units of the power range of 300÷1400MW, pressure range of 230÷260bar and temperature of 540÷590°C, including 14 units of double secondary superheating, were set working. In the years 1990÷1998 in Japan and China total output power installed in coal electric power stations has increased threefold. The growth was achieved mainly by applying the units of output power in the range of 400÷700MW, working with the supercritical steam parameters of 255bar/570÷590°C and the secondary superheating of 570÷595°C temperature range. In the years 2000÷2003 three 700MW units based on the 246bar/593°C/593°C steam parameters, two 900MW units based on the 241bar/593°C/593°C steam parameters, two 900MW units based on the 241bar/600°C/610°C steam parameters, three 1000MW units based on the 245bar/600°C/600°C steam parameters and two 1050MW units based on the 250bar/600°C/610°C steam parameters, were put in operation. In Europe significant achievements in building the power units with supercritical parameters can be noted in Denmark and Germany. In 1984 in Denmark the first unit with supercritical parameters was set working in the Studstrupvaerket electric power station. At the beginning of the 21st century two 411MW units with the 290bar/582°C/580°C/580°C steam parameters, including one coal-fired and the other gas-fired, as well as 530MW unit with the 300bar/580°C/600°C steam parameters, working on combusted biomass, were put in operation in Avedore electric power station. Germans, basing on the achievements and operational experience of Danes in the area of building coal electric power plants with high steam parameters, have built mainly 800÷900MW power units fitted with brown coal-fired boilers. In 2002, 1012MW power unit based on the 274bar/580°C/600°C steam parameters was built in the Niederaussem electric power station. A list of selected power units (presently installed or planned ones) intended for the operating with supercritical parameters is presented in Tab. 1. Pątnów II electric power station is the first Polish electric power plant based on supercritical

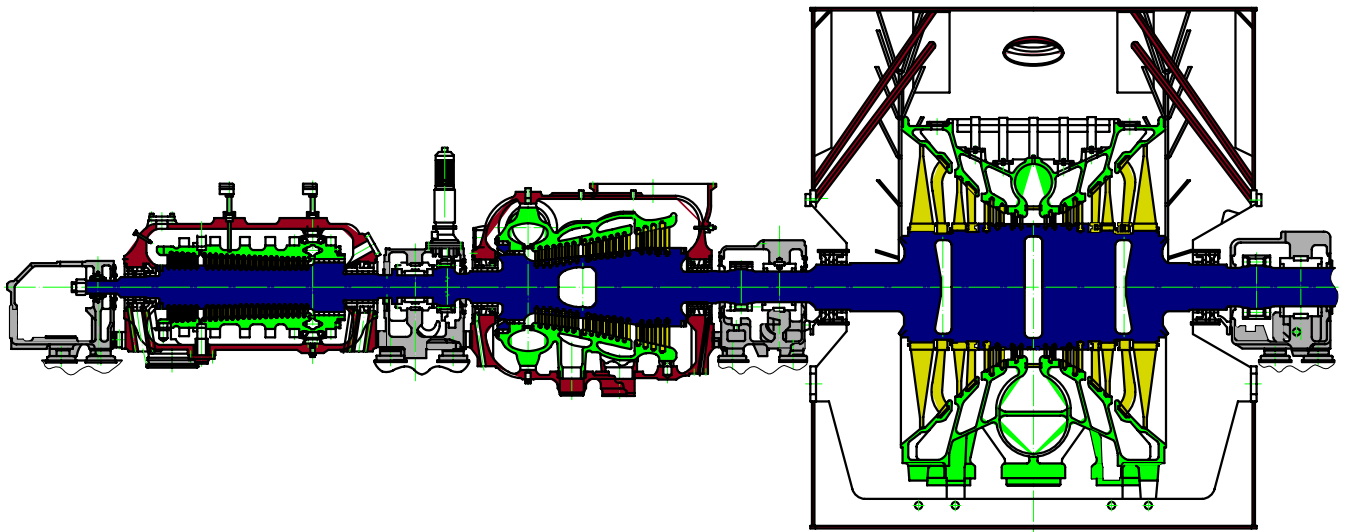

Fig. 2 Cross-section of 28K460 turbine installed in Łagisza electric power station

parameters. Its high energy conversion efficiency is associated with lower fuel consumption and limited emission of contaminations to the environment. And, the power unit built in Łagisza is fitted with the biggest in the world monotube boiler of circulation fluid-bed, operating with supercritical parameters. The modern ecological power unit would reach very high efficiency equal to about 45%. Its turbine-set parameters are as follows: electric output power of 460MW, fresh steam pressure of 275bar, fresh steam temperature of 560°C, secondary steam temperature of 580°C, secondary steam pressure of 54.6bar. The steam cycle schematic diagram as well as the turbine-set cross-section are presented in Fig. 1 and 2, respectively.

supercritical boilers deliver the steam of 25MPa pressure and 600°C temperature and abt. 610°C superheating temperature, to steam turbine cycle. It is expected that further development of the technology would be focused on the mastering of ultrasupercritical parameters as well as the increasing of efficiency of power units. This mainly depends on progress to be done in the area of material engineering [1], [2], [3], [5], [7], [9], [13], [15], [16], [17], [22], [28], [29], [30], [31], [32], [34], [39], [40], [48], [49], [50]. Investigations are also carried out in the frame of large international projects such as e.g. THERMIE 700 Advanced Power Plant project financially supported by EU, whose simplified scheme is given in Fig. 3, aimed at the obtaining of fresh steam temperature of the order of 700°C and 37.5 MPa pressure. The setting in motion of the power unit is scheduled on 2015 [16].

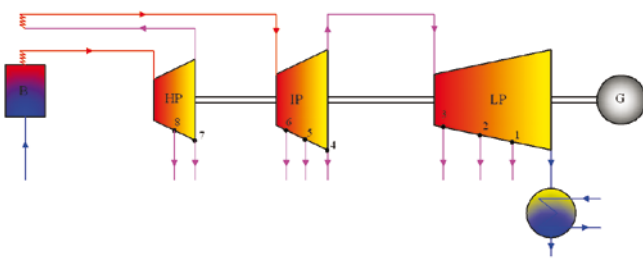

Fig. 1 Simplified steam cycle diagram of Łagisza electric power plant

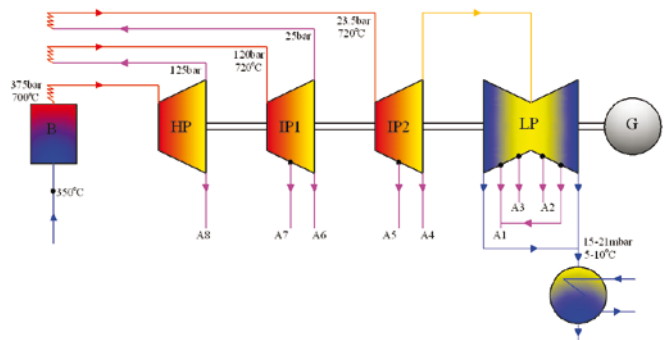

Fig. 3 Simplified schematic diagram of THERMIE 700 steam cycle

And, in the electric power station of Belchatów S.A., the largest conventional one in Poland and Europe, working on brown coal and being the biggest electric power producer in Poland, the building of a 833MW power unit based on supercritical parameters has been started. The unit with the 266bar/554/582°C steam parameters is intended for the fundamental mode of operation of 7500 h/year usage time of its rated power and the total working time of 8100 h yearly. By applying supercritical steam parameters it is already possible to obtain thermal efficiency of over 45% as compared with that of 41÷42% achievable today by conventional thermal electric power plants. Contemporary pulverized-fuel

power plants fitted with turbines operating with supercritical parameters, in which fresh steam (of 26MPa and 570°C) is produced by cooling nuclear reactors. Efficiency of such systems exceeds 45%, as compared with that of the order of 33% in the case of the power plants co-working with light-water-cooled reactors [4], [38].

High steam temperatures in steam turbine cycles require the first and second stage of turbine placed behind the secondary superheating, to be cooled. The simplified

Tab. 1. List of selected power units with supercritical parameters, installed in electric power stations worldwide [1], [2], [7], [9], [13], [21], [25], [29], [36], [37], [44], [45] * -planned units or those under construction

| No. | Electric power station | Country | Power [MW] | Steam parameters [bar/°C/°C] | Efficiency [%] | Year of building |
|-----|------------------------|------------|------------|------------------------------|----------------|------------------|
| 1 | Schwarze Pumpe | Germany | 2x800 | 250/544/562 | 41 | 1992 |
| 2 | Staudinger Unit | Germany | 500 | 250/540/560 | 43 | 1993 |
| 3 | Rostock | Germany | 550 | 285/545/582 | - | 1994 |
| 4 | Schwarze Pumpe A/B | Germany | 800, 900 | 250/580/600 | 33.8 | 1997 |
| 5 | Hässler | Germany | 720 | 272/578/600 | 47.6 | 1997 |
| 6 | Schkopau | Germany | 2x480 | 285/545/582 | - | 1997 |
| 7 | Lübeck | Germany | 400 | 275/580/600 | 43.6 | 1998 |
| 8 | Lippendorf | Germany | 2x800 | 268/554/554 | 42.4 | 2000 |
| 9 | Boxberg | Germany | 1000 | 266/545/581 | 43 | 2000 |
| 10 | Bexbach II | Germany | 750 | 259/575/595 | 44.2 | 2002 |
| 11 | Niederaussem | Germany | 1000 | 275/580/600 | 45.2 | 2002 |
| 12 | Hemweg-8 | Holland | 700 | 250/535/563 | 44 | 1994 |
| 13 | Studstrupvaerket | Denmark | 400 | 270/540/540 | 42 | 1985 |
| 14 | Fynsvaeket-7 | Denmark | 420 | 250/540/540 | 43.5 | 1991 |
| 15 | Esbjerg 3 | Denmark | 415 | 250/560/560 | 45.3 | 1992 |
| 16 | Skaerbaek-3 | Denmark | 410 | 290/582/580/580 | 49 | 1997 |
| 17 | Nordjylland-3 | Denmark | 410 | 290/582/580/580 | 47 | 1998 |
| 18 | Avedore-2 | Denmark | 450 | 300/580/600 | 45 | 2001 |
| 19 | USC 2005 | Denmark | - | 330/610/630/630 | 51 | 2005 |
| 20 | Meri Pori | Finland | 550 | 244/540/560 | 45 | - |
| 21 | Kawagoe-1&2 | Japan | 700 | 319/571/569/569 | - | 1989-90 |
| 22 | Hekinan-3 | Japan | 700 | 255/543/593 | - | 1993 |
| 23 | Nanao-ohta | Japan | 500 | 246/566/593 | - | 1994 |
| 24 | Noshiro-3 | Japan | 600 | 246/566/593 | - | 1994 |
| 25 | Haranomaschi | Japan | 1000 | 246/566/593 | - | 1997 |
| 26 | Matsuura-2 | Japan | 1000 | 255/598/593 | 41 | 1997 |
| 27 | Haramashi | Japan | 1050 | 259/604/602 | - | 1998 |
| 28 | Nanaoota-2 | Japan | 700 | 255/597/595 | - | 1998 |
| 29 | Tachibana-Wan | Japan | 1050 | 285/605/613 | - | 2001 |
| 30 | Tachibana-Wan-2 | Japan | 3x700 | 250/600/610 | 42/44 | 2000 |
| 31 | Tsuruga-2 | Japan | 700 | 255/597/595 | - | 2000 |
| 32 | Misumi-1 | Japan | 600 | 250/605/600 | 46 | 2001 |
| 33 | Isogo-1 | Japan | 1x600 | 251/600/610 | 46 | 2002 |
| 34 | Tomoto Atsuma-4 | Japan | 700 | 250/600/600 | - | 2002 |
| 35 | Hitachinaka | Japan | 1000 | 245/600/600 | 43.1 | 2003 |
| 36 | Waigaoqiao-1&2 | China | 2x900 | 250/538/566 | 42.7 | 2004 |
| 37 | Yuhuan | China | 4x1000 | 262.5/600/600 | - | 2008 |
| 38 | Changshu | China | 600 | 259/569/569 | 42 | - |
| 39 | Wangqu | China | 600 | 247/571/569 | 43 | - |
| 40 | Waigaoqiao-1&2 | China | 1x1000 | 270/600/600 | - | 2009 |
| 41 | Yonghungdo | Korea Pld. | 2x800 | 246/566/566 | 43.5 | 2004 |
| 42 | Torrevaldaliga | Italy | 6x600 | 250/600/600 | 45 | 2006 |
| 43 | Millmerran | Australia | 2x430 | 249/568/595 | 37.4 | 2001 |
| 44 | Callide | Australia | 420 | 251/566/565 | 39.4 | 2001 |
| 45 | Tarong Nth | Australia | 443 | 250/566/565 | 39.2 | 2002 |
| 46 | Kogan Creek | Australia | 750 | 250/540/560 | 37.1 | 2007 |
| 47 | Tanners Creek | USA | 580 | 241/538/552 | 39.8/42 | - |
| 48 | Duke Power | USA | 1120 | 241/538/538 | - | - |
| 49 | Pątnów II | Poland | 464 | 266/544/566 | 44.3 | 2007 |
| 50 | Genesee at Sunset | Canada | 495 | 241/566/566 | - | 2005 |
| 51 | Lagisza * | Poland | 460 | 275/560/580 | 45 | - |
| 52 | Belchatów * | Poland | 833 | 266/554/582 | - | 2010 |
| 53 | Neurath * | Germany | 2x1100 | 270/600/610 | - | 2010 |
| 54 | Boxberg R * | Germany | 670 | 286/600/610 | - | 2010 |
| 55 | Dateln * | Germany | 1100 | 286/600/610 | - | 2011 |
| 57 | Moorburg * | Germany | 2x820 | 276/600/610 | - | 2010 |
| 58 | Walsum * | Germany | 790 | 274/603/621 | - | 2010 |
| 59 | Karsruhe * | Germany | 820 | 250/600/620 | - | 2011 |
| 60 | Hamm * | Germany | 800 | 286/600/620 | - | 2012 |
| 61 | AD700EU Project * | Germany | - | 375/700/720/720 | 50-55 | 2020 |

schematic diagram of the external cooling is shown in Fig. 4. The cooling steam taken before the first superheating is directed to the high-pressure (HP) part, to be mixed with the superheated steam. The cooling steam for the first stages of the intermediate-pressure (IP) turbine is taken from the third or fourth stage of HP turbine.

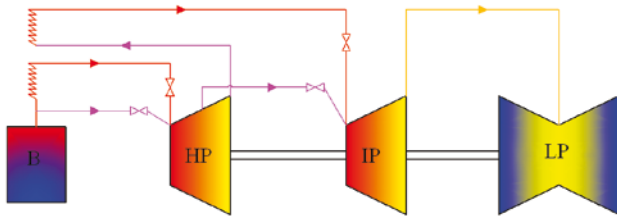

Fig. 4 Schematic diagram of external cooling

Application of the high parameters is associated with necessity of using special materials. Elements of HP and IP turbines, which are in direct contact with superheated steam, are made of a high-alloy steel (of high percentage content of such elements as Cr, Mo and V). The first stages of HP and IP turbine are made of Ni-alloy steel which is resistant to thermal loads resulting from the difference between temperature of superheated steam and that of steam after expansion. The low-pressure (LP) turbine module is made of NiCrMoV-high-alloy steel. The material is brittle-crack resistant due to lowered content of such elements as P, Sn, Mn and Si and increased Ni content. For the LP part it is very important to appropriately design the last stages exposed to high loads and erosion.

In present for steam temperatures up to 600°C ferritic steels, e.g. SAVE12 steel, are used; for temperatures over 650°C – austenitic steels, e.g. SUPER304H steel and HR6W steel; and for temperatures in the range of 620÷720°C – various alloys, e.g. Inconel 617, Haynes 230, Inconel 740 etc. Tab. 2 shows chemical element composition of selected kinds of materials used for the units of supercritical parameters.

To produce the steam of supercritical parameters, monotube boilers with elements made of special steels (e.g. high-temperature creep resisting, austenitic or ferritic-martensitic ones), are used. For its flow system a turbine-driven water-feed pump of high elevation head is necessary to overcome high flow drag resulting from higher density of medium and smaller internal diameters of pipes in the boiler. Another kinds of steam generators with supercritical parameters are atmospheric fluid-bed boilers as well as those of circulation fluid-bed.

Boilers of pressurized fluid-beds make it possible to reach higher power concentration and higher efficiency values. Circulation fluid-bed technology in association with supercritical steam parameters constitutes a safe solution, more technologically and economically effective than the option of pulverized-fuel boiler. Advantages of the technology are: fuel flexibility, possible co-combustion of coal, sludge and biomass, compliance with WE80/2001/EU directive in the area of pollution emission, limitation of hazard to occurrence of high-temperature corrosion and erosion, increasing power unit's cycle efficiency due to heat recovery and lowering exhaust gas temperature, uniform distribution of heat flow in combustion chamber as well as improved dynamics of load changes [2], [3], [7], [8], [10], [11], [12], [14], [22], [23], [24], [27], [33], [41], [42], [46], [47].

Results of calculations of steam cycles

The increasing of fresh steam pressure and temperature at steam pressure in condenser kept constant, is the first step to the achieving of a higher cycle efficiency [6], [18], [19], [26], [32]. Successive figures present respectively: Fig. 5 – relation of ideal efficiency, Fig. 6 – real efficiency, and Fig. 7 – cycle efficiency -with wetness loss taken into account -of Clausius-Rankine cycle, all in function of fresh steam pressure (5÷55MPa) and temperature (500÷760°C) at condenser internal pressure kept constant (4kPa); and, in each of the figures the dryness degree limit line ($x_{gr}=0.85$) is depicted. The figures illustrate the possibly obtainable increase of efficiency in function of values of fresh steam parameters at inlet to turbine, at condenser internal pressure kept constant. In the diagrams can be distinctly observed the limitation of upper value of steam initial pressure, resulting from the limit wetness. The C-R cycle ideal efficiency obtainable due to application of high fresh steam parameters exceeds 52% (see Fig. 5), whereas the real efficiency of the cycle does not exceed 43% (see Fig. 6). It should be also noted that the real efficiency of the cycle in which steam wetness degree has been taken into account does not exceed 39%, and that C-R cycle optimum pressure values amount to about 100 bar (see Fig. 7). The applied here notion of the taking into account of wetness degree means that work is done only by steam and that water does not provide any work [26].

Application of the interstage superheating is the next way to increase efficiency of the cycle with steam turbine. Its efficiency depends, apart from fresh steam parameters and condenser internal pressure, on superheating pressure

Tab. 2. List of chemical element composition of materials used for the power units of supercritical parameters [14]

| Name/Composition | C | Si | Mn | Ni | Cr | W | Co | V | Nb | N | Ta | Nd | Cu | Ti | B | Al | Mo | Fe | La |
|------------------|------|-----|------|------|------|------|------|------|------|------|------|------|-----|------|-------|------|-----|-----|------|
| SAVE12 | 0.01 | 0.3 | 0.20 | - | 11.0 | 3.0 | 3.0 | 0.20 | 0.07 | 0.04 | 0.07 | 0.04 | - | - | - | - | - | - | - |
| SUPER304H | 0.1 | 0.2 | 0.8 | 9.0 | 18.0 | - | - | - | 0.4 | 0.1 | - | - | 3.0 | - | - | - | - | - | - |
| HR6W | 0.08 | 0.4 | 1.2 | 43.0 | 23.0 | 6.0 | - | - | 0.08 | - | - | - | - | 0.08 | 0.003 | - | - | - | - |
| Haynes 230 | 0.07 | - | - | - | 22.0 | 14.0 | 12.5 | - | - | - | - | - | - | - | - | 1.0 | 9.0 | - | - |
| Inconel 617 | 0.1 | - | - | 55.0 | 22.0 | - | 5.0 | - | - | - | - | - | - | - | 0.015 | 0.35 | 2.0 | 3.0 | 0.02 |
| Inconel 740 | 0.03 | 0.5 | 0.03 | 48.3 | 25.0 | - | 20.0 | - | 2.0 | - | - | - | - | 1.8 | - | 0.9 | 0.5 | 0.7 | - |

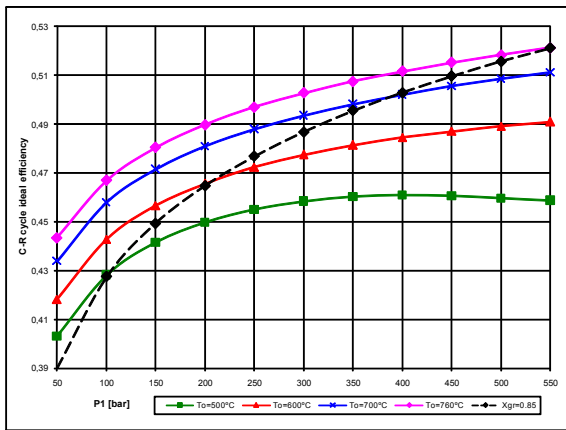

Fig. 5 Relation of ideal efficiency of Clausius-Rankine cycle in function of fresh steam pressure and temperature at condenser internal pressure kept constant (4kPa), and the wetness degree limit curve $x_{gr}=0.85$

value too. There is one optimum pressure value for which the cycle efficiency reaches its maximum. In steam power units various configurations of the system with single interstage superheating applied in the boiler are possible. The solution in which HP part and IP part are placed in a common casing, is often applied. The integrated HP/IP module is connected with LP part which can be of single or double jet. Such system is characteristic of compact structure and lower investment and operational costs. The units which operate with supercritical parameters and have that kind of structure can reach output power of over 600 MW. The system in which HP and IP turbine parts are placed in separate casings is only sporadically applied. In the units of a greater power the solution in which single-jet HP part and double-jet IP part are placed in separate casings and connected with double-jet LP part, is applied. The LP module is consisted of one, two or three casings, depending on the output power the unit has to develop. In practice, finds also application the system in which the first casing contains HP part and single-jet IP part of countercurrent flow, and in the other casing double-jet IP part connected with LP module consisted of two casings, is placed. Its alternative is to place HP and IP parts in separate casings [2], [6], [9], [15], [18], [19], [26], [32], [33], [35], [36].

The profits resulting from the application of double superheating became obvious as early as in 1960s. In optimizing the cycle with double secondary superheating attention should be paid to appropriate choice of the pressure for the first and second superheating.

In practice the 1st superheating pressure is selected depending on thermodynamic optimum, the 2nd superheating pressure is usually chosen depending on an assumed steam temperature at inlet to LP turbine. Maximum temperature of inlet steam to LP part is limited with respect to thermal strength of materials. Classical turbine-set consists of three separate modules designed for definite steam parameters, i.e.: HP, IP, and LP parts. Electric generator is directly connected with the last part, i.e. LP. The arrangement of steam turbine for supercritical parameters depends first of all on choice of a kind of secondary superheating, unit's operation range as well as special requirements as to regenerative preheating. To the arrangement with double superheating the solution in

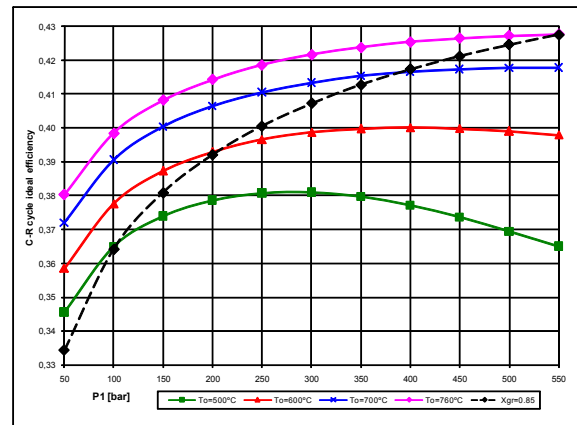

Fig. 6 Relation of real efficiency of Clausius-Rankine cycle in function of fresh steam pressure and temperature at condenser internal pressure kept constant (4kPa), and the wetness degree limit curve $x_{gr}=0.85$

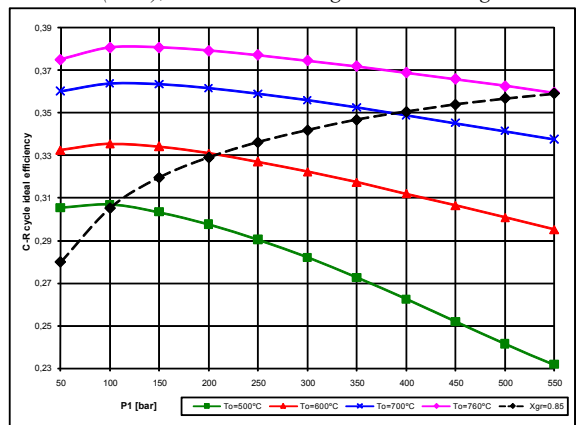

Fig. 7 Relation of Clausius-Rankine cycle efficiency (with steam wetness degree taken into account according to Bauman formula) in function of fresh steam pressure and temperature at condenser internal pressure kept constant (4kPa), and the wetness degree limit curve $x_{gr}=0.85$

which HP part is placed in a separate casing and connected with casing of double-jet IP part after 2nd superheating, is often applied. LP part is consisted of one or two casings. In order to obtain higher power values the solution in which HP parts and IP1 part after 1st superheating are placed in common casing, is used. The second casing is intended for IP2 double-jet part after 2nd superheating, connected with LP module consisted of one, two or three double-jet parts [2], [6], [9], [15], [18], [19], [26], [32], [33], [35], [36].

Increase of cycle efficiency to a large extent depends on an appropriate choice of number and kind of preheaters. Regenerative preheating is a very important element of the power unit and it influences the unit's main elements, i.e. boiler, turbine, condenser and feed pump. The increased jet of steam produced in boiler, resulting from regeneration, is associated with the necessity of fitting the unit with feed pumps of greater capacity. High feed water temperature makes it difficult to maintain low exhaust gas temperature on which to a large extent depends boiler efficiency. It should be also remembered that along with increasing number of exchangers degree of complexity of the entire system also increases, that consequently leads to increasing investment cost. The first step in optimizing the system is to select an appropriate number of regeneration stages. To high power units 6-10 stages of superheating are usually applied. When considering profits due to

application of regenerative superheating attention should be first of all paid to possible achieving higher efficiency of turbine stages. Drop of steam jet in LP part makes blade system forming easier and, on the other hand, absorption of steam from interstage space of the turbine makes its design more complex and results in generating flow losses within the turbine [6], [18], [19], [26].

In this work the analysis is performed of the cycles with single and double interstage superheating and, additionally, with the regenerative feed water preheating system fitted with six, seven, eight, nine and ten regenerative heat exchangers. Respective calculations were performed for various values of fresh steam temperature (500°C, 600°C, 700°C) and pressure (5÷65MPa), various pressure values of secondary superheating: $p_2=(0.24\div0.36)*p_0$, and $p_{2,1}=(0.06\div0.12)*p_0$, as well as with internal pressure value in condenser maintained constant (4kPa). The performed calculations indicate that the increase of efficiency of the steam cycle with double interstage superheating and extended regeneration, up to 51%, is possible.

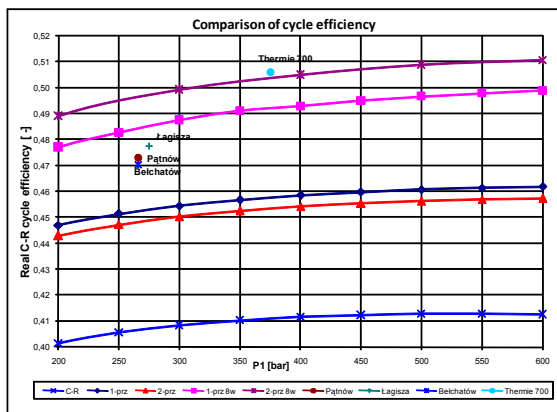

Fig. 8 Comparison of efficiency of steam turbine cycles of various configurations, including values for Polish electric power stations operating with supercritical parameters

Fig. 8 presents comparison of efficiency of the following cycles:

- Clausius-Rankine cycle (marked C-R);
- The steam cycle with single interstage superheating without regeneration (marked 1-prz);
- The steam cycle with single interstage superheating and 8 regenerative heat exchangers (marked 1-prz 8w);
- The steam cycle with double interstage superheating without regeneration (marked 2-prz);
- The steam cycle with double interstage superheating without regeneration and 8 regenerative heat exchangers (marked 2-prz 8w);
- The steam cycle with supercritical parameters operating in Pałnów electric power station (marked Pałnów);
- The steam cycle with supercritical parameters operating in Łagisza electric power station (marked Łagisza);
- The steam cycle with supercritical parameters

operating in Bełchatów electric power station (marked Bełchatów);

- The demonstrative cycle for supercritical parameters (marked Thermie 700).

Fig. 8 was prepared for optimum values of interstage superheating pressure, fresh steam temperature (of 700°C) and constant value of condenser internal pressure (of 4kPa) in function of fresh steam pressure (in the range of 20÷60MPa). From the diagram it can be concluded that the application of double interstage superheating increases the cycle efficiency by about 1.5 % as compared with that of the cycle with single superheating and by about 9 % as compared with the simple C-R cycle.

Summary

In Poland coal plays the most important role in the process of electric power production. With a view of its resources, gained experience and reliability of the coal-based technology of electric power production that fuel will be dominating for electric power generation in the years to come. Ecological and energy policy, both in Poland and EU, compels to apply low-emission technologies, e.g. clean coal-based technology. In Poland, because of its coal resources and its role for the state's energy balance, investments in clean coal technologies should be a natural phase of power industry development in this country. Other probable development directions of Polish power industry are a.o. the following: coal gasification integrated with high-temperature fuel cells, power systems with fuel cells combined with coal hydro-gasification, coal gasification and liquefaction, coal-nuclear synergy systems, pressurized coal combustion in fluid-bed boilers, combined production systems of electric power and hydrogen, or polygeneration. In the age of greater and greater electric power demand and stronger and stronger limitations imposed on emission of noxious compounds to the atmosphere, development of power production technologies based on supercritical and ultrasupercritical parameters, seems inevitable. The turbine power units fed with steam of supercritical parameters, which have been built so far, are characteristic of a higher efficiency and lower carbon dioxide emission, resulting from it.

Bibliography

1. Avrutskii G. D., Savenkova I. A., Lazarev M. V., Akulenko V. V., Shvarts A. L., Ivanov S. A.: Development of Engineering Solutions for Creation of Turbine Plant for Power Unit With Supercritical Steam Parameters. Power Technology and Engineering Vol. 39, No. 6, 2005;
2. Baumgartner R.: Advanced Coal Technology to Power the World. World Bank Energy Week, Siemens Power Generation, Germany, 2006;
3. Beer J. M.: High efficiency electric power generation: The environmental role. Progress in Energy and Combustion Science 33, 2007;
4. Boehm C., Starflinger J., Schulenberg T., Oeynhaus H.: Supercritical Steam Cycle for Lead Cooled Nuclear Systems. Paper No. 035, Proceedings of GLOBAL 2005, Tsukuba, Japan, Oct 9-13, 2005;
5. Bugge J., Kjaer S.: High-Efficiency Coal-Fired Power Plants Development and Perspectives. Elsam Engineering A/S, 2004;
6. Chmielniak T.: Power technologies (in Polish). Publishing House of Silesian University of Technology (Wydawnictwo Pol. Śląskiej), Gliwice, 2004;
7. Chmielniak T.: Development state and prospects of power units for electric power stations based on pulver technique (in Polish). Silesian Cluster for Clean Coal Technologies (Śląski Klastr Czystych

- Technologii Węglowych), Gliwice, 2007;
8. Coleman K., Viswanathan R., Shingledecker J., Sarver J., Stanko G., Mohn W., Borden M., Goodstine S.: Boiler Materials for Ultrasupercritical Coal Power Plants. USC Materials, Quarterly Report October, December 2003 -January 23, 2004;
 9. DTI Brochure: Advanced Power Plant Using High Efficiency Boiler/Turbine. Best Practice Brochure No. BPB010, Carbon Abatement, Technologies Programme, 2006;
 10. Goidich S. J., Wu S., Fan Z., Bose A. C.: Design Aspects of the Ultra-Supercritical CFB Boiler. International Pittsburgh Coal Conference, Pittsburgh, PA, Sept. 12-15, 2005;
 11. Goidich S. J., Fan Z., Sippu O., Bose A. C.: Integration of Ultra-Supercritical OTU and CFB Boiler Technologies. International Pittsburgh Coal Conference, Pittsburgh, PA, Sept. 12-15, 2005;
 12. Golec T. et al.: Scenarios of technological development of power production based on hard and brown coal versus energy supply safety of the state (in Polish). Instytut Energetyki, Zakład Procesów Ciepłych (CPC), Katowice, 2006;
 13. Golec T., Rakowski J., Świrski J.: Prospects of technical progress in electric power production based on hard coal, brown coal as well natural gas with taking into account effects to the environment (in Polish). *Elektroenergetyka*, Nr 1/2004 (48), 2004;
 14. Holcomb G. R., Alman D. E., Bullard S. B., Covino Jr. B. S., Cramer S. D., Ziomek-Moroz M.: Ultra-Supercritical Steam Corrosion. U. S. Department of Energy, Albany Research Center, 1450 Queen Avenue SW, Albany, OR 97321, 2003;
 15. Hurd P., Truckenmueller F., Thamm N., Pollak H., Neef M., Deckers M.: Modern Reaction HP/IP Turbine Technology Advances & Experiences. Proceedings of PWR2005-50085, ASME POWER, Chicago, Illinois, April 5-7, 2005;
 16. Kjaer S., Bugge J., Stolzenberger C.: Europeans still aiming for 700°C steam. MPS Review Supercritical PF Technology, Modern Power Systems - November 2004;
 17. Kolev N., Schaber K., Kolev D.: A new type of a gas-steam turbine cycle with increased efficiency. *Applied Thermal Engineering* 21, 2001;
 18. Kosowski K.: Ship Turbine Power Plants Fundamentals of Thermodynamical Cycles. Publishing House of Gdańsk University of Technology (Wydawnictwo Politechniki Gdańskiej), Gdańsk; 2005;
 19. Kosowski K. et al.: Steam and gas turbines with examples of Alstom technology. Alstom, France, Switzerland, United Kingdom, Poland, 2nd edition – three parts in one volume, ISBN 978-83-925959-3-9, 2007;
 20. Kretzschmar H.-J., Cooper J. R., Dittmann A., Friend D. G., Gallagher J. S., Harvey A. H., Knobloch K., Mareš R., Miyagawa K., Okita N., Stöcker I., Wagner W., Weber I.: Supplementary Backward Equations $T_p, h_{p, \dots}, v_p, h_{p, \dots}$, and $T_p, s_{p, \dots}, v_p, s_{p, \dots}$ for the Critical and Supercritical Regions. Region 3... of the Industrial Formulation IAPWS-IF97 for Water and Steam. *Journal of Engineering for Gas Turbines and Power*, Vol. 129, January 2007;
 21. Leizerovich A. S.: Steam Turbines for Modern Fossil-fuel Power Plants. ISBN:0881735485, Inc NetLibrary, 2007;
 22. Masuyama F.: History of Power Plants and Progress in Heat Resistant Steels. *ISIJ International*, Vol. 41, No. 6, 2001;
 23. Nowak W.: Development state and prospects of power units of electric power stations based on fluid technique (in Polish). Silesian Cluster for Clean Coal Technologies (Śląski Klaster Czystych Technologii Węglowych), Gliwice, 2007;
 24. Oakey J. E., Pinder L. W., Vanstone R., Henderson M., Osgerby S.: Review of Status of Advanced Materials for Power Generation. Report No. COAL R224, DTI/Pub URN 02/1509, 2003;
 25. Paul I.: Supercritical coal fired power plants. A Technology Successfully Deployed in Developing Countries. Siemens Power Generation, 2002;
 26. Perycz S.: Steam and gas turbines (in Polish). Publishing House of Gdańsk University of Technology (Wydawnictwo Politechniki Gdańskiej), Gdańsk; 1988;
 27. Pitsinki J.: An example of novel energy technologies for power production – OTSC CFB boiler. International Conference on Early Stage Energy Technologies and Tool Training Seminar for Assessment of their Market Potential, 31th May, 2005;
 28. Radenco V., Vasilescu E. E., Popescu G., Apostol V.: New approach to thermal power plants operation regimes: maximum power versus maximum efficiency. *International Journal of Thermal Sciences* 46, 2007;
 29. Rakowski J., Pinko L., Świrski J.: Ecological aspects of electric power production by domestic thermal electric power stations (in Polish). Int. Conf. on Ecological Aspects of Electric Power Production (Międzynarodowa Konferencja Ekologiczne Aspekty Wytwarzania Energii Elektrycznej), Warsaw, 14-16 November 2001;
 30. Rao A. D., Samuelsen G. S., Robson F. L., Geisbrecht R. A.: Coal-Based Power Plant System Configurations for the 21st century. GT2003-38942, Proceedings of ASME Turbo Expo 2003, Atlanta, Georgia, USA, June 16-19, 2003;
 31. Rao A. D., Samuelsen G. S., Robson F. L., Geisbrecht R. A.: Coal-Based Power Plant System Configurations for the 21st century. GT2004-53105, Proceedings of ASME Turbo Expo 2004, Vienna, Austria, June 14-17, 2004;
 32. Retzlaff K. M., Ruegger W. A.: Steam Turbines for Ultra-Supercritical Power Plants. GER-3945A, GE Power Generation, 1996;
 33. Riordan T.: New Generation Strategy of Ultra-Supercritical Technology. *New Generation Design & Eng.*, APP Site, 2006;
 34. Romanosky R. R., Rawls P. A., Purgert R. M., Viswanathan V. R.: Steam Turbine Materials for Ultra Supercritical Coal Power Plants. *Advanced Research, National Energy Technology Laboratory*, 08/2007;
 35. Rosenkranz J., Wichtmann A.: Balancing economics and environmental friendliness -the challenge for supercritical coal-fired power plants with highest steam parameters in the future. Siemens Power Generation, Germany, 2005;
 36. Susta M. R., Peter P.: Supercritical Steam Power Plants -an Attractive Option for Malaysia. Kuala Lumpur 28-29 April 2003, Malaysia Power 2003;
 37. Susta M. R., Seong K. B.: Supercritical and Ultra-Supercritical Power Plants – SEA’s Vision or Reality?. *POWERGEN ASIA 2004*;
 38. Tulkki V.: Supercritical Water Reactors. A Survey on International State of Research in 2006, Otaniemi, November 6, 2006;
 39. Turek M.: Scenarios of technological development of coal-based power industry (in Polish). Instytut Energetyki, Zakład Procesów Ciepłych (CPC), Katowice, 2006;
 40. Venäläinen I., Psik R.: 460 MWe Supercritical CFB Boiler Design for Lagisza Power Plant. PowerGen, Barcelona, Spain, 2004;
 41. Viswanathan R., Henry J.F., Tanzosh J., Stanko G., Shingledecker J., Vitalis B., Purgert R.: U.S. Program on Materials Technology for Ultra-Supercritical Coal Power Plants. *Journal of Materials Engineering and Performance*, Volume 14 (3), June 2005;
 42. Viswanathan R., Coleman K., Rao U.: Materials for ultra-supercritical coal-fired power plant boilers. *International Journal of Pressure Vessels and Piping*, 83, 2006;
 43. Wagner W., Kretzschmar H.-J.: International Steam Tables Properties of Water and Steam Based on the Industrial Formulation IAPWS-IF97 Tables, Algorithms, Diagrams, and CD-ROM Electronic Steam Tables. Springer-Verlag, Berlin, Heidelberg, 2008;
 44. Watanabe S., Tani T., Takahashi M., Fujii H.: 495-MW Capacity Genesee Power Generating Station Phase 3: First Supercritical Pressure Coal-fired Power Plant in Canada., Hitachi, Ltd. and Babcock-Hitachi, 2001;
 45. Wibberley L., Cottrell A., Palfreyman D., Scaife P., Brown P.: Techno-Economic Assessment of Power Generation Options for Australia. *Technology Assessment Report* 52, 2006;
 46. Wright I.G., Maziasz P.J., Ellis F.V., Gibbons T.B., Woodford D.A.: Materials Issues For Turbines For Operation In Ultra-Supercritical Steam. Research sponsored by the U.S. Department of Energy, Office of Fossil Energy, Advanced Research Materials Program, under Contract DE-AC05-00OR22725 with UT-Battelle, LLC., 2004;
 47. Yi Y-S., Watanabe Y., Kondo T., Kimura H., Sato M.: Oxidation Rate of Advanced Heat-Resistant Steels for Ultra-Supercritical Boilers in Pressurized Superheated Steam. *Journal of Pressure Vessel Technology*, Vol. 123, 2001;
 48. Zaporowski B.: Economic effectiveness analysis of electric power production by the system’s electric power stations and combined thermal-electric power production by small thermal-electric power plants (in Polish). Proceedings of 3rd Scientific Technical Conference on Electric Power Plants and Thermal-Electric Power Gas and Steam-Gas Fed Plants (Materiały III Konferencji Naukowo-Technicznej: Elektrownie i elektrociepłownie gazowe i gazowo-parowe), Poznań-Kiekrz, 2005;
 49. Zaporowski B.: Economic effectiveness analysis of gas-fired thermal-electric power plants after introduction of origin certificates of highly efficient co-generation (in Polish). *Rynek Energii* nr 6 (73), 2007;
 50. Ziębik A.: Future EU Energy MIX -Will Coal Play an Important Role?. Silesian Cluster for Clean Coal Technologies (Śląski Klaster Czystych Technologii Węglowych), Gliwice, 2007.