

Investigations of influence of screw propeller operation on water flow around stern part of ship hull

Tadeusz Koronowicz
Zbigniew Krzemianowski
 Institute of Fluid-Flow Machinery,
 Polish Academy of Sciences
 in Gdańsk

ABSTRACT

This paper presents results of measurements of velocity field in before- the - propeller flow in presence of a ship model hull of two configurations, as well as comparative calculations of velocity field on a full-scale ship. Analysis of the research results showed that input data to Biot-Savart formula should be modified in the case of calculations of propeller-induced velocities on ship hull surface.

Keywords : ship hydromechanics, propeller-induced velocities, Biot-Savart equation.

INTRODUCTION

In the 1990s in Ship Propeller Division, Institute of Fluid-Flow Machinery, Polish Academy of Sciences (IMP PAN), the computer model basin PANSHIP was elaborated. It has been aimed at simulation of ship hull model tests in ship model basin as well as relevant calculations for full-scale ship hull.

The computer model basin is a computer software system consisted of a dozen or so mutually cooperating programs [1÷6]. Crucial elements of the system are the programs capable of taking into account the influence of screw propeller operation on flow around ship hull. The software contains the programs with the use of which a change of hull resistance resulting from propeller suction action can be determined, and those by which the influence of propeller operation on velocity field in behind-the-hull flow can be taken into account.

The initial calculations performed by using the PANSHIP software have yielded generally correct results with the exception of one element : changes of hull resistance resulting from propeller operation. In ship theory such change is expressed in the form of the so-called thrust deduction t :

$$t = (R_T - R_0)/T = (T - R_0)/T$$

where :

- R_0 – resistance of hull without propeller
- T – propeller thrust
- R_T – resistance of hull with operating propeller (identified with propeller thrust)

The quantity t is usually determined during every ship model propulsion tests in model basin.

As such tests have been performed every year for many ship models, a very rich collection of experimental data in this

domain has been gathered. Basing on them one can unambiguously state : the more full form of a ship the greater value of its thrust deduction t .

In the preliminary version of the computer model basin in question, for hulls of more full forms, greater and greater differences between calculated values of thrust deduction and those experimentally determined for the same hulls, were obtained (Fig.1). Due to prior research on flow around propeller it was possible to diagnose that **the velocities induced by whirls representing the propeller, determined by means of the Biot-Savart formula, obtained erroneous values on the hull surface**. In Fig.2 it can be observed that the more full form of a hull the smaller values of the induced velocities calculated from the original Biot-Savart formula, therefore the calculated pressures (under-pressures) on the hull surface take also smaller values.

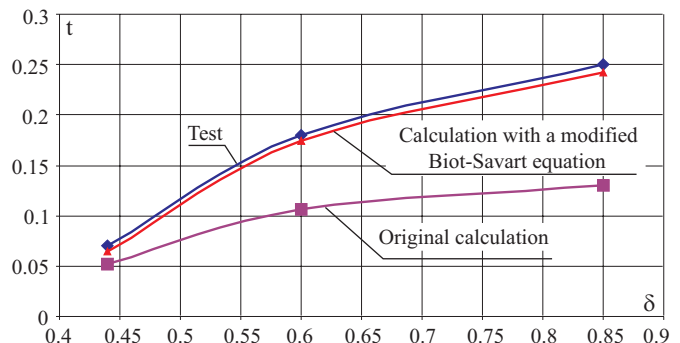

Fig. 1. A simplified diagram of the relation between the thrust deduction and hull block coefficient (in reality the relation is more complex as it depends first of all on fullness of stern part of hull) .

By analyzing the diagrams presented in Fig.2 and 3 it can be explained why such results have been obtained.

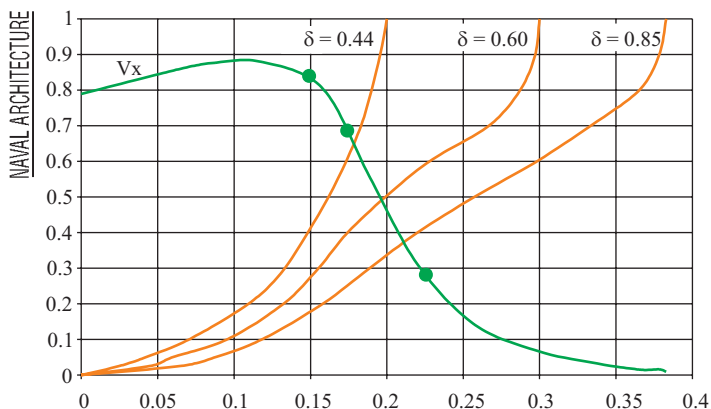

Fig. 2. Distribution of axial component of velocity in before-the-propeller flow, obtained from the original Biot-Savart formula, shown on the background of frame sections of hulls having various block coefficients.

If the velocities induced by the whirl system which represents propeller blades and propeller race, are calculated from the original Biot-Savart formula then the velocity distribution starts at the hull plane of symmetry (the point C' in Fig.3). The similar velocity distribution is presented in Fig.2, where simultaneously the frame sections of 3 ship hulls of different values of the block coefficient δ are shown. It can be observed that the greater fullness of the hull the smaller obtained values of velocities induced on its surface.

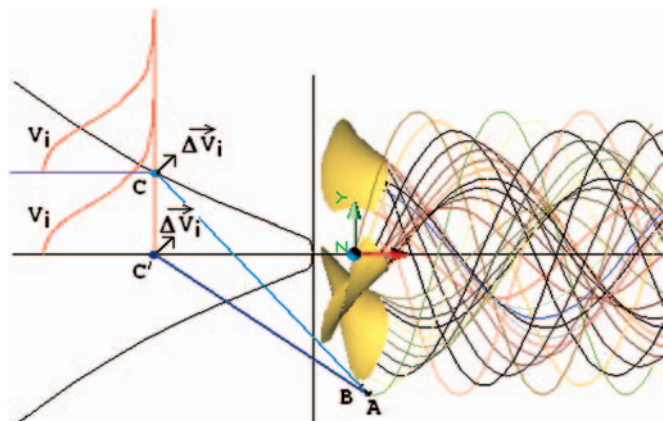

Fig. 3. Schematic presentation of the modification of data input to the Biot-Savart formula.

In the up-to-date version of the PANSHIP, was implemented a new method of calculation of induced velocities by means of Biot-Savart formula, (called the engineering method). The propeller-induced velocities were calculated in the point C' (Fig.3), but they were considered as the velocities calculated on the hull (the point C on the hull). It means that zero-value of the coordinate perpendicular to the hull plane of symmetry was put in the Biot-Savart formula. The calculation results appeared significantly better. Values of the thrust deduction obtained from calculations and those from experiments became more and more similar to each other. Obviously the described method of determination of induced velocities is only approximate, however, as revealed from practice, it yielded satisfactory results in engineering applications without any special modifications of the software.

For many years the so-modified computer software PANSHIP has been in use, and the hypothesis associated with the modification of input data for Biot-Savart formula was confirmed by comparing calculation results with experimental ones. However it was necessary to test the hypothesis by means of direct measurements of the field of the propeller - induced velocities around the hull. Such a verification is the subject of the presented work.

The model tests were performed at the Ship Hydromechanics Centre of CTO [10]. They consisted in measuring the velocity field around stern part of ship both without any propeller and with operating propeller.

The investigations were conducted on the ship model having its main particulars as follows :

| | | |
|-------------|---|----------------|
| Length b.p. | – | 6.515 m |
| Breadth | – | 0.977 m |
| Draught | – | 0.376 m |
| Model scale | – | $\lambda = 33$ |

The hull frame sections are shown in Fig.4.

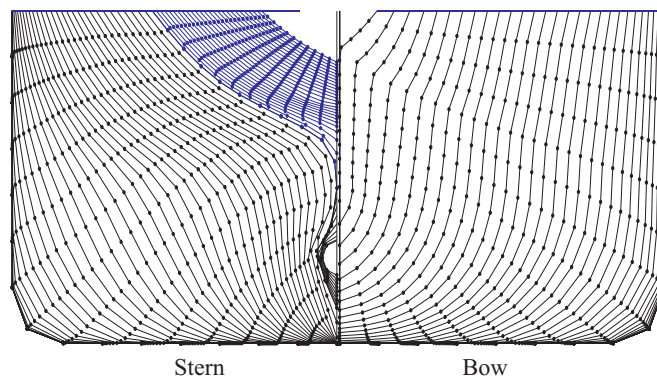

Fig. 4. Image of the panels projected on the model frame sections.

The applied measuring instrument (the measuring sounder fitted with the single five-hole spherical head PKN(5+4)/8/1) made it possible to measure the velocity components V_x , V_y , V_z in the hull-fixed rectangular coordinate frame :

- x – component : along ship axis of symmetry and hull motion direction
- y – component : perpendicular to the hull plane of symmetry
- z – component : perpendicular to the hull water plane.

The measurement space was located at the port side of the hull.

Distance of propeller working plane from aft perpendicular – $X_p = 124$ mm

Distance of propeller axis from plane of symmetry – $Y_p = 0.0$ mm

Distance of propeller axis from base plane – $Z_p = 109.1$ mm.

The measurement plane was located $\Delta X = 157$ mm fore from the propeller working plane.

EXPERIMENTAL TESTS

The measurements were performed at one value of the ship model velocity $V_M = 1.75$ m/s and four values of rotational speed of the propeller model. The first value of rotational speed was determined for zero-value of propeller thrust. It was assumed that this was the rotational speed at which propeller-induced velocities on the hull were of negligibly small values, hence the velocity measurements could be considered equivalent to the tests on the hull without propeller. The value of $n_0 = 7.3$ rps resulted from the tests (during the tests values of both propeller - induced thrust and torque as well as hull resistance were measured).

The next three values of rotational speed were so selected as to obtain only significantly large values of propeller - model-induced velocities. With taking into consideration the working

range of the measuring dynamometer the following three values of rotational speed were selected :

$$n_1 = 25 \text{ 1/s} ; n_2 = 30 \text{ 1/s} \\ n_3 = 35 \text{ 1/s}.$$

At the obtained values of rotational speeds the values of propeller thrust were many times greater than that of hull resistance at the speed $V_M = 1.75 \text{ m/s}$.

The measurements were conducted along two measurement lines perpendicular to the longitudinal plane of symmetry of the hull, **XZ**, placed by $\Delta X = 157 \text{ mm}$ apart from the propeller working plane. **The first line is placed at the height of propeller rotation axis, the other - 50 mm above the mentioned axis.**

The first measurement point was selected as close to the hull surface as possible, and the successive points were placed at every **20 mm** up to the distance assumed negligible from the point of view of propeller – induced velocities.

The selected measurement results are presented in Fig. 5÷8 whereas the complete set of them - in CTO's report [10], and their graphical representation - in the IMP PAN report [11]. Values of the velocity components V_x , V_y , V_z and of the total velocity V_c can be found there. During all the tests the ship model speed V_M was kept equal to 1.75 m/s .

In Fig.5 are presented the measurement results at the rotational speed $n = 7.3 \text{ 1/s}$ corresponding with zero-value of propeller model thrust. Hence it can be assumed that the velocities shown in Fig. 5 correspond with those around the hull without propeller. They have been taken as the reference point for determining the velocities induced by working propeller model.

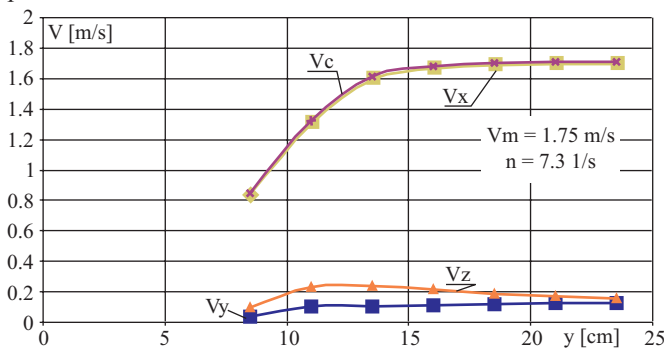

Fig. 5. Velocity components along the measurement line located at the height of the propeller axis, for $n = 7.3 \text{ 1/s}$ (thrust of zero-value) .

In Fig. 6, 7 and 8 are presented results of the measurements at higher rotational speeds of propeller model, for which induced velocities should already show significant values. In Fig.9 it can be observed in which way values of the axial component (marked x) change along with rotational speed changing.

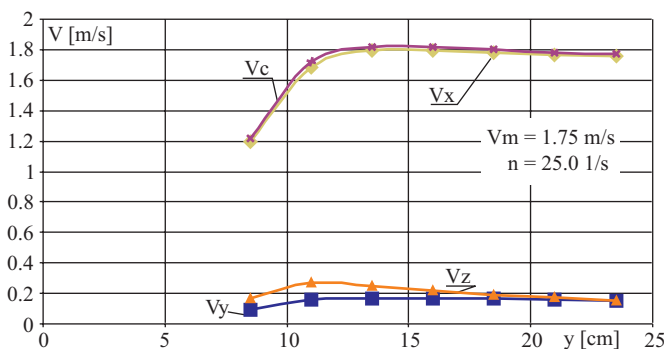

Fig. 6. Velocity components along the measurement line located at the height of the propeller axis, for $n = 25 \text{ 1/s}$.

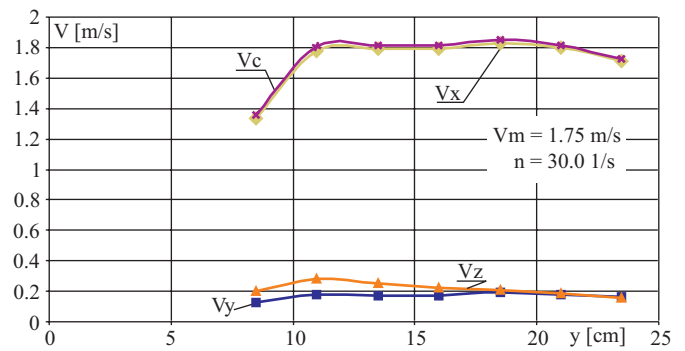

Fig. 7. Velocity components along the measurement line located at the height of the propeller axis, for $n = 30 \text{ 1/s}$.

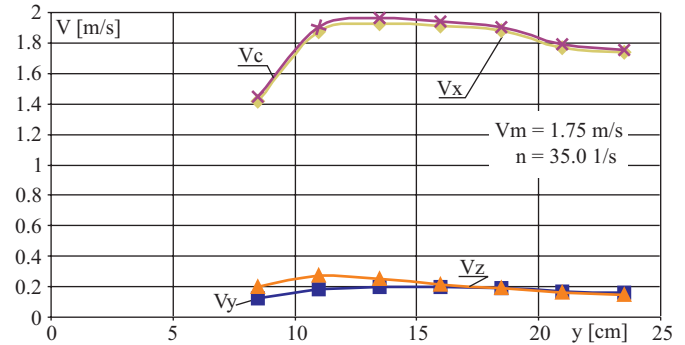

Fig. 8. Velocity components along the measurement line located at the height of the propeller axis, for $n = 35 \text{ 1/s}$.

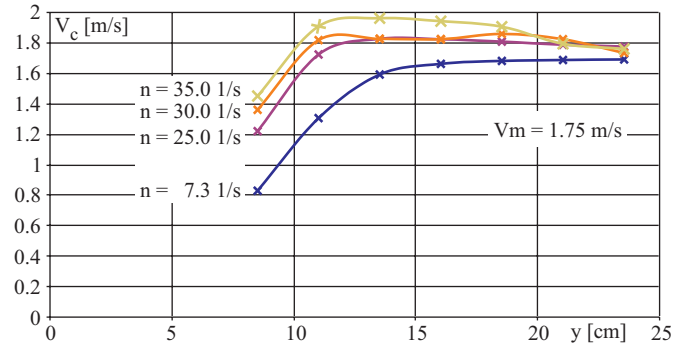

Fig. 9. Modules of velocities along the measurement line located at the height of the propeller axis, for various values of propeller rotational speed .

In Fig.10 are presented the differences between the velocities obtained at high values of rotational speed and the velocity corresponding with the thrust of zero-value. They should correspond with the propeller-induced velocities but the character of the changes indicates that the influence of viscosity on the velocity distribution is significant (induced velocities make velocity distribution in the boundary layer changing).

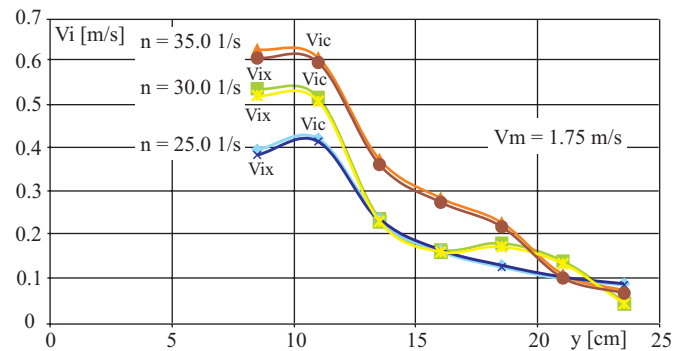

Fig. 10. Axial component and module of propeller-induced velocity along the measurement line located at the height of the propeller shaft axis .

Similar measurements were performed at the measurement line located in the same plane but at the height above the propeller rotation axis by 50 mm. For the measurements only the final diagram of the propeller induced velocities is presented.

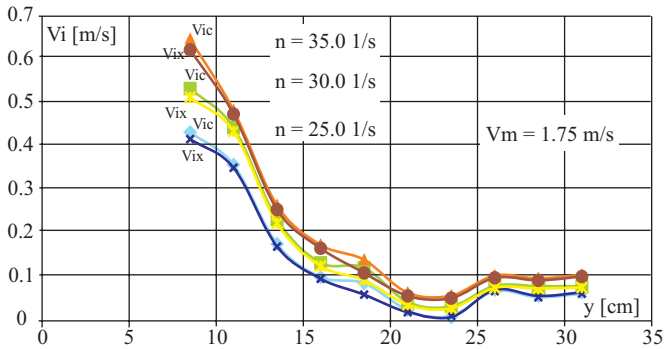

Fig. 11. Axial component and module of propeller-induced velocity along the measurement line located at the height above the propeller shaft axis by 50 mm .

Analyzing the above presented results of the investigations, especially those of Fig. 10 and 11, one can state that the share of propeller-induced velocities in the total velocity is significant (intentionally the values of propeller rotational speed considerably exceeded the own propulsion point of the model, which, for the velocity $V=1.75$ m/s, approximately corresponded with the rotational speed of 13 rps).

To confirm hull influence on calculation results of propeller-induced velocities it should be necessary to perform measurements in two frame cross-sections located nearby to each other but having significantly different transverse offsets (breadth). Unfortunately, for many years the ship models designed and tested have been characterized by slender stern forms. For this reason the second cross-section was chosen beyond the stern. In order to maintain the distance between the working plane and measurement cross-section the way of fastening the propeller shaft was changed. The stern part of the hull was modified by extending the stern tube in such a way as to get the measurement cross-section placed beyond the stern and the propeller model placed at the same distance as in the case of basic tests (Fig. 12). The tests on such hull version were called the tests on the Ship 2.

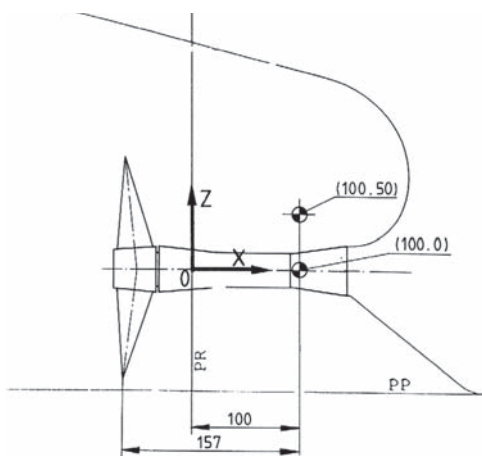

Fig. 12. Location of measurement lines on the ship model with the modified stern. PP - Base plane, PR - Aft perpendicular .

The measurements were performed at the same ship model speed $V_M = 1.75$ m/s and four values of rotational speed of propeller model, in the same way as in the first cycle of investigations. Their results for the sounder located at the height of the shaft axis are presented in Fig. 13. (The comprehensive set

of the results from the measurements and calculations can be found in the CTO report [10] and IMP PAN report [11]).

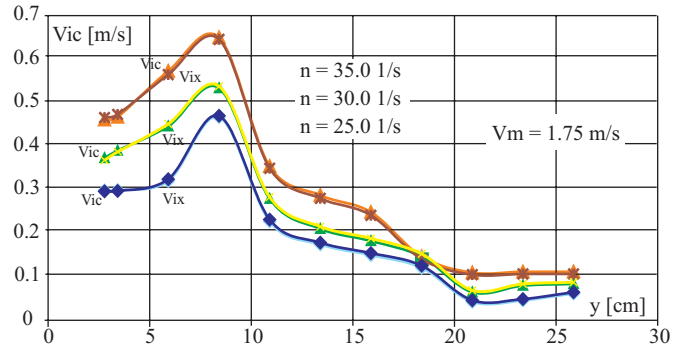

Fig. 13. Axial component and module of propeller-induced velocity measured at the height of the propeller shaft axis of the ship model with the modified stern, at the distance of 157 mm before the propeller .

Comparing, with each other, the measurement results for both versions of propeller fastening (Fig. 14) one can state that the curves are mutually shifted. The difference is approximately equal to the difference of hull breadth and propeller shaft in the places where the measurements have been performed in both versions of the tests.

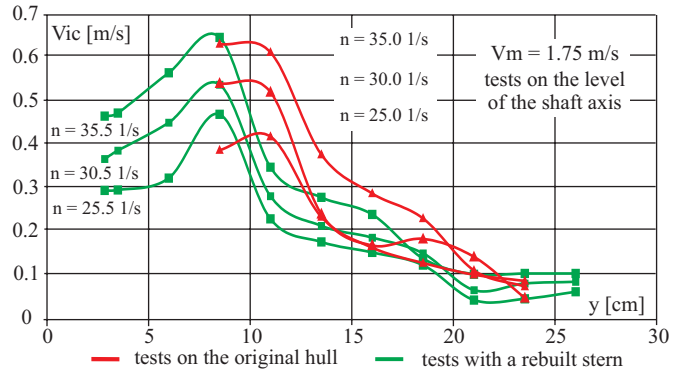

Fig. 14. Comparison of induced velocities obtained from the tests on the models with the original stern and modified one .

Therefore the experimental tests fully confirmed the put hypothesis as follows :

Calculations of the velocities around ship hull, induced by whirl systems representing the propeller itself and propeller race, make it necessary to modify input data to Biot-Savart formula, and as a result of the tests in question the proposed modification of the input data has been proved correct.

TESTS ON FULL-SCALE SHIP

The scientific aim of the presented investigations is to improve the algorithm applied in the software for calculating 3D velocity field in the stern part of full-scale ship with taking into account propeller operation [7]. Therefore an important element of the investigations is to verify such field on a full-scale ship.

It is very hard to achieve reliable results from full-scale measurements of such field. In the subject-matter literature are known results of the measurements performed, both in model - and full-scale, on the hull of HSVA tanker ship, realized under the auspices of the model basin in Hamburg.

The measurements of the velocity field before the propeller working on the full-scale ship were carried out through a window panel fitted in the stern part of the hull. They were conducted with the use of a laser anemometer but only respective to the axial component of total velocity (i.e. with taking into account propeller-induced velocities) The measurement

results are presented in the form of diagrams of isotachs, and only in the range covered by laser beam (Fig.15). The measurements were performed at the distance $X = 0.21D$ from aft perpendicular. The broken line denotes the propeller circle of the diameter $D = 6.1$ m.

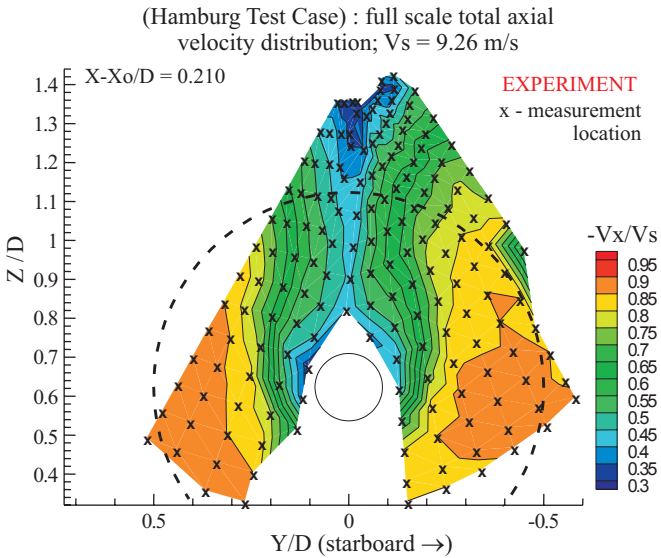

Fig.15. Results of the measurements of axial velocity component, performed on the ship with operating propeller .

And, in Fig.16 are presented the calculation results obtained from the modified PANSHIP software, also concerning only the axial component of velocity in the same cross-section before the propeller.

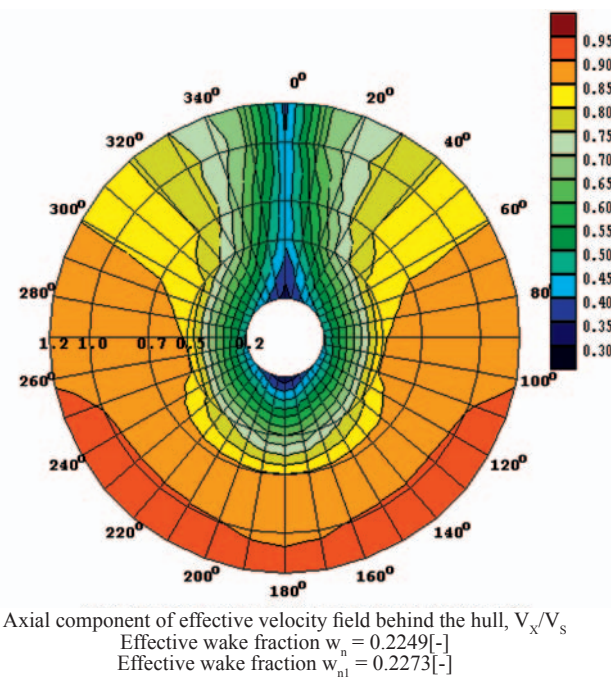

Fig. 16. Results of the measurements of axial velocity component, performed on the ship with operating propeller .

On the basis of analysis of the achieved results of calculations, performed on the background of measurement results (compare Fig.15 and Fig.16), a qualitative similarity of both fields can be stated. Quantitative comparison can be more clearly presented in another form. In Fig.17, 18 and 19 the same results are shown in the form of diagrams of velocity at a given radius. To this end three radiuses : $r/R = 1.0$, 0.7 and 0.5 were selected.

If only accuracy of the measurements on the full-scale ship are taken into consideration (the curves presented in the figures should be symmetrical respective to the ship plane of symmetry) then the so-presented results are found astonishingly similar for the radiuses $r/R = 1.0$, and especially $r/R = 0.7$). It means that the PANSHIP software correctly determines the velocity field in the behind- the- hull flow and correctly expresses the velocity field induced by the propeller. In the diagrams are presented total velocity values which are formed along a considerable length of hull stern part at a significant share of propeller-induced velocities. It confirms that the PANSHIP can be successfully applied to the scaling of velocity fields on full-scale ship [7].

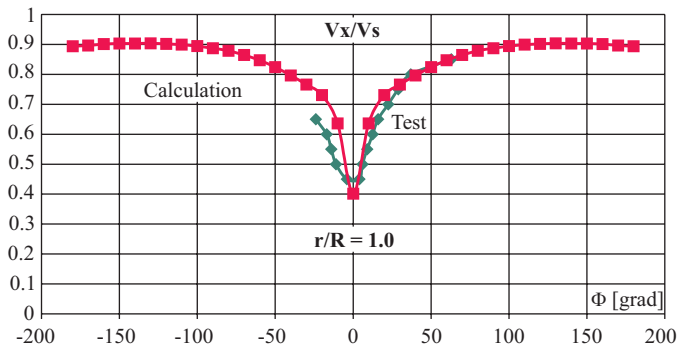

Fig. 17. Comparison of the axial component of before-the-propeller velocity at the radius $r/R = 1.0$, obtained from measurements and calculations for the full-scale ship, respectively .

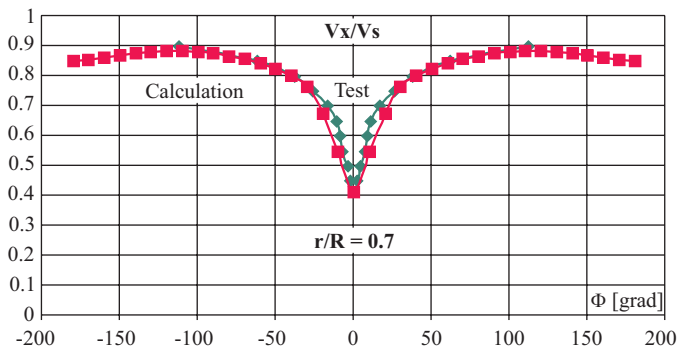

Fig. 18. Comparison of the axial component of before-the-propeller velocity at the radius $r/R = 0.7$, obtained from measurements and calculations for the full-scale ship, respectively .

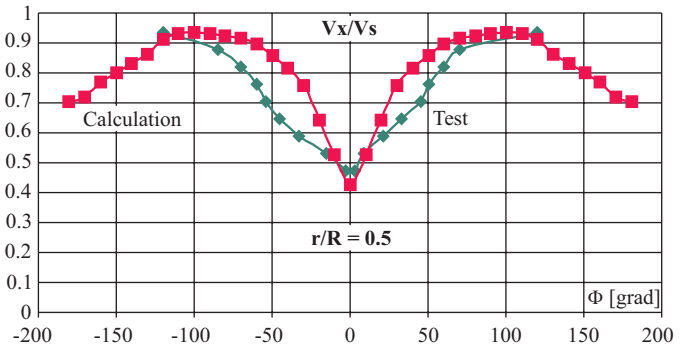

Fig. 19. Comparison of the axial component of before-the-propeller velocity at the radius $r/R = 0.5$, obtained from measurements and calculations for the full-scale ship, respectively .

FINAL REMARKS

- It can be concluded that the obtained experimental tests fully confirmed the proposed hypothesis : **Calculations of velocities around the ship, induced by whirl systems representing the propeller itself and propeller race require input data to Biot-Savart formula to be modified.**

- The proved hypothesis can be considered as a kind of discovery in fluid mechanics (in handbooks on hydromechanics and subject-matter literature no mention on that theme can be found)
- However further theoretical research aimed at building a correct form of Biot-Savart formula in multiply connected space, is necessary
- The proposed modification of the way of calculations of velocities induced around ship hull can be tentatively implemented in engineering practice as an effective approximation.

NOMENCLATURE

- B – hull breadth
 D – propeller diameter
 L – hull length
 n – number of propeller revolutions per second
 r – radius of cylindrical cross-section around propeller axis
 R – propeller radius
 R_0 – hull resistance
 R_T – resistance of hull with operating propeller
 t – thrust deduction
 T – propeller thrust, also hull draught
 V_M – model speed
 V_S – ship speed
 V_c – total velocity $\sqrt{(V_M + V_x)^2 + V_y^2 + V_z^2}$
 V_i – induced velocity
 V_{ic} – total induced velocity $\sqrt{V_x^2 + V_y^2 + V_z^2}$
 V_x, V_y, V_z – velocity components
 X_p, y_p, z_p – coordinates of propeller axis location
 y – distance of measurement points from hull plane of symmetry
 δ – hull block coefficient
 Δ – hull buoyancy
 ΔV_i – velocity induced by whirl filament's element
 λ – model scale

BIBLIOGRAPHY

1. Bugalski T., Koronowicz T., Szantyr J., Waberska G.: *Computer software for determining flow around the ship together with wave system* (in Polish). Proceedings of 10th Symposium on ship hydromechanics, Gdańsk. 1993
2. Bugalski T., Koronowicz T., Szantyr J., Waberska G.: *Computer system for calculation of flow, resistance and propulsion of a ship*; Paper presented at CADMO'94. Southampton UK, 1994
3. Bugalski T., Koronowicz T., Szantyr J., Waberska G.: *A method for calculation of flow around the hull of a ship moving in calm water with constant velocity*; Marine Technology Transactions, vol. 5. 1994
4. Koronowicz T., Tuskowska T., Bugalski T., Grabowska K.: *The influence of propeller operation on the pressure field on the hull and around it*; Proceedings of 12th International Conference on Hydrodynamics in Ship Design, HYDRONAV'97, Szklarska Poręba, September 1997
5. Koronowicz T., Szantyr J., Bugalski T.: *Theoretical model for determining the pressure field resulting from hull flow and operation of the marine propeller*; Polish Maritime Research, September 1997
6. Koronowicz T., Tuskowska T., Waberska G.: *Computer software system for determining the pressure field resulting from hull flow and operation of the marine propeller*; Polish Maritime Research, December 1997
7. Koronowicz T.: *A computer method for prediction of the velocity field behind a full-scale ship hull*, Polish Maritime Research No 1/2003, vol. 10
8. Koronowicz T., Tuskowska T., Waberska G.: *Modernization of the calculation model applied to the computer software PANSHIP* (in Polish). IMP PAN Report
9. Koronowicz T., Tuskowska T., Waberska G., Kaniecki M., Krzemianowski Z.: *Analysis of preliminary results of tests* (in Polish). Report no. 4643/04. IMP PAN
10. Jaworski S.: *Results of measurements of velocity field before the propeller which operates on ship model and axially symmetrical bodies* (in Polish). Technical report no. RH-2004/T-149, Ship Design & Research Centre
11. Koronowicz T., Tuskowska T., Waberska G., Kaniecki M., Krzemianowski Z.: *Analysis of results of velocity field tests on the model 1* (in Polish). Report no. 4864/04, IMP PAN (Institute of Fluid-Flow Machinery, Polish Academy of Sciences in Gdańsk)
12. Koronowicz T., Koronowicz J., Niewiadomski J., Bunikowski J., Huk G.: *Measurements of propeller-induced velocity field around an axially symmetrical body in cavitation tunnel* (in Polish). Report no. 5065/05, IMP PAN
13. Koronowicz T., Tuskowska T., Waberska G., Kaniecki M., Krzemianowski Z., Koronowicz J., Chaja P., Bednarek A.: *Analysis of results of tests of an axially symmetrical body in model basin* (in Polish). Report no. 5104/05, IMP PAN
14. Koronowicz T., Bugalski T.: *Analysis of results of tests of a ship* (in Polish), Report no. 5220/05, IMP PAN
15. Koronowicz T., Krzemianowski Z.: *Experimental research on propeller influence on flow around ship hull* (in Polish). Materials of MWK-2005, vol. III, Waplewo 17-20 May 2005
16. Koronowicz T., Krzemianowski Z.: *The numerical and experimental tests of the work of a screw propeller on the flow around the hull on a ship*, Materials of the International Conference HYDRONAV'05, Gdańsk-Ostróda

CONTACT WITH THE AUTHORS

Prof. Tadeusz Koronowicz
 Zbigniew Krzemianowski, D.Sc., Eng.
 Institute of Fluid-Flow Machinery,
 Polish Academy of Sciences
 Fiszera 14
 80-952 Gdańsk, POLAND
 e-mail : ttk@interecho.com

C onference

REGIONAL GROUP of the Section on Exploitation Foundations

On 25 May 2006 the Regional Group of the Section on Exploitation Foundations, Machine Building Committee, Polish Academy of Sciences (PAS), held its successive scientific seminar organized by Faculty of Engineering Sciences, Warmia - Mazury University in Olsztyn.

Scientific workers of the Faculty presented the following papers :

- *A method for improving operation processes of track engine* – by B. Kolator
- *Application of Exsys Covrid to maintenance of machines* – by K. Ligier and A. Rychlik
- *A system for maintaining the machines in tero-technological approach* – by P. Mikołajczak

After discussion and replies from the side of the authors to questions directed to them, the organizers presented scientific laboratories of the Faculty.