

Information and Navigation System for Person with Visual Impairment

Jaroslav Cechak

Abstract—The paper deals with the area of the technical solution of the information and navigation system intended for persons with visual impairment. The first part is focused on the transfer of information concerned using the conductivity properties of the human body as a transmission channel. This principle is referred to as Personal Area Network (PAN). The principle used of data transmission through the human body can be implemented in several specific applications.

The second part of the paper addresses the area of navigation for persons with visual impairment to ensure their easier orientation in an unknown terrain. This part is focused on the navigation of the visually impaired, for their easier orientation in unknown areas. The technical navigation system, whose hardware is integrated into the standard stick for the blind, is based on the principle of a digital analysis of a signal from the magnetometer. The analyzed signal occurs by moving the stick over surface-distributed neodymium magnets, which, with their distribution and orientation of magnetic poles, creates basic orientation pictograms.

The conclusion of the paper describes the design of an information and navigation system that the authors have practically implemented and tested.

Keywords—Visual impairment, remote guidance, personal area network.

I. INTRODUCTION

A LONG with the development of electronic systems, the field of information and guidance systems for visually impaired people has been developing in recent decades. Although we may not know it, there are almost 200,000 people living with this handicap in the Czech Republic. The free service of the SONS navigation centre has been introduced in the Czech Republic and it is based on GPS – GSM technology. The blind person sends his or her position to the control station by mobile phone and GPS receiver, and a trained staff member gives him/her advice by phone as to the most convenient way of getting to a destination. TYFLOSET® – an electronic orientation and information system for the blind and people with heavy visual impairment, has spread widely. TYFLOSET is made up of a set of technical portable, mobile and stationary means, which serve for the transmission of acoustic and voice information and easier orientation of the blind in built-up areas, mass urban transportation means, suburban and rail transport, and at crossroads, in underpasses, in the underground, around offices and hospitals, etc.

Strategic Studies and Analysis Subdivision, URC – Systems, Prazakova 49, 65 619 00 Brno, Czech Republic (e-mail: jaroslav.cechak@urc.systems.cz).

The presented article was made with support of the Ministry of Industry and Trade within the solution of project TIP-MNO FR-TI1-056.

II. INFORMATION SYSTEM BASED ON THE PAN PRINCIPLE

Use of the properties of the human body for signal or data transmission was proposed in 1995. The PAN concept is based on the fact that the contemporary electronic equipment used by users consists, in principle, of a microcontroller, a display, a keyboard, a microphone input and headset output, a battery and many other common hardware circuits. These circuits are rather redundant and jointly consume considerable amounts of battery power. Nowadays, separately carried equipment usually communicates over a metallic line, infrared, WiFi, ZigBee or Bluetooth ports. The data or signals are transmitted at a distance of several tens of centimetres or units of metres. Therefore, an experiment was conducted to provide one person with all electronic equipment as part of a PAN and to have simultaneously one system consisting of, for example, one common keyboard, one microcontroller, one headset, one display, etc. The electric properties of the human body can be used for data transmission among such devices, so that the body itself functions as a transmission channel [1]–[8].

In fact, the transmitting/receiving electrodes or pairs of transmitter/receiver electrodes need not be conductively-connected to the surface of the body: the capacitance coupling is often sufficient. Capacitance – electrostatic coupling ensures that the signal or data are transmitted between the transmitter and the receiver – assuming that a suitable capacitance coupling is available to provide earthing between the input and output circuits. Many conference papers describe experiments made regarding PAN, the vast majority of which have focused on the principle of electrostatic coupling. The main protagonists in this field include various electronics companies that have participated in the development of PAN type equipment designed to transmit an audio signal from a music platform to wireless headsets.

However, research has been suspended, primarily because of signal losses or interference in the transmission path encountered in situations where people held hands or came into bodily contact during equipment use, or where the concentration of people was high, e.g. on public transporting means of mass transportation, etc. However, there are applications where the above negative property of the equipment does not matter and is indeed often beneficial. This, for example, relates to persons with vision impairment. In this case, it is required to obtain information content easily or information content in another language for foreign visitors.

The use of the PAN principle for a person with vision impairment has led to the design of equipment that can be relatively easily implemented in various information boards

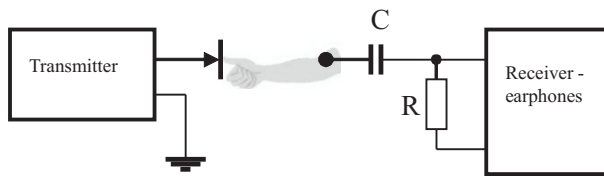

Fig. 1. Information system communication principle – capacitance coupling.

or other information systems permanently installed in state administration buildings, galleries, zoological or botanical gardens, etc.

For a block diagram of the information system refer to Fig. 1. The information system is divided into two basic, independently operating parts, i.e. into the transmitter and receiver of the information system. In order to transmit data using the conductivity properties of the human body, an appropriate frequency band, as already discussed in several sources – shall fall within the range of the values 100 kHz – 5 MHz.

The frequency band defined in such a way shall have the following properties:

- signal attenuation between the touch area of the transmitter and receiver due to conductivity characteristics of human body is less than 50dB,
- in the given frequency band, a relatively high quantity of computer switch-mode power sources and other sources are in operation which might cause a severe interference,
- the touch area size is many times smaller than the wavelength of carrier frequency, and thus any unnecessary radiation of the HF signal to the environment does not occur.

For the transmission in the given frequency band, the modulation of both amplitude and frequency type can be used. At first, verifications were made to determine whether the SP-DIF interface properties can be used, because many PC sound cards are equipped with the aforementioned interface, and several, already introduced, integrated circuits exist that serve as a D/A converter. In addition, the rate of serial data transmission via the SP-DIF interface is within the band below 3MHz. Using a battery oscilloscope, the measurements of signal characteristics were made when the operator touched the outlet terminals of the SP-DIF converter with one hand, and the inlet probe was placed on the arm of the other hand.

For the recorded curves of various values of load resistor, please refer to Fig. 2. The curve in Fig. 2a shows an obvious distortion of pulse leading and descending edges at the application of the 1 kOhm load resistor. On the other hand, the curve in Fig. 2b shows a relatively negligible distortion of pulse leading and descending edges at the application of the 1 Mohm load resistor, but with a superimposed heavy alternating 50 Hz component due to the available mains that is greater than the useful signal. For the practical use of the SP-DIF interface, it is necessary to firstly remove the undesirable 50 Hz superimposed component using a high-pass type filter, and restore the shape of the leading and descending edges. For this purpose, a Schmitt toggle circuit or a limiting amplifier to enable the shaping of the output circuits can be used.

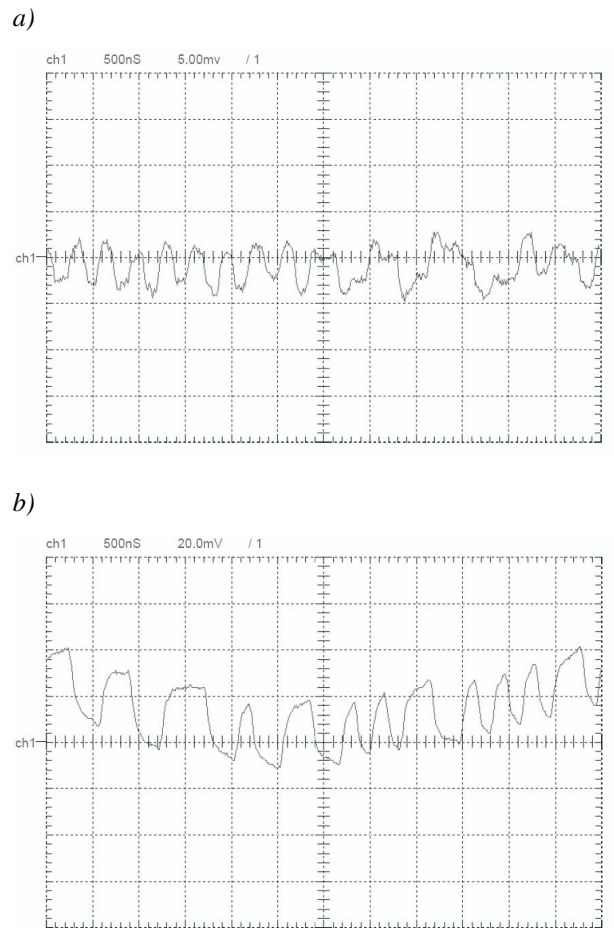

Fig. 2. Curve of the SP-DIF signal, a) without the C element, R=1 kΩ, b) without the C element, R=1 MΩ.

Nevertheless, practical experience obtained during laboratory testing has shown that the proper functioning of the D/A converter with the SP-DIF serial interface is very susceptible to short-term data failures accompanied with synchronization disintegration, which results in an unpleasant click at reproduction. In many cases it was even necessary to turn the equipment off and on again to reset the initialization and restore the synchronization.

For the above reasons, we have attempted to find a solution which will not require the proper functioning that the synchronization pulses be restored to ensure the proper timing of the D/A converter. A possible solution consists in the application of amplifiers, class D.

III. SIGNAL TRANSMISSION VIA A D-CLASS AMPLIFIER

Class D amplifiers work by generating a square wave of which the low-frequency portion of the spectrum is essentially the wanted output signal, and of which the high-frequency portion serves no purpose other than to make the wave-form binary so it can be amplified by switching the power devices. The binary waveform is derived using pulse width modulation – PWM. The most basic way of creating the PWM signal is to use a high speed comparator that compares a high frequency triangular wave with the audio input. This generates a series of pulses of which the duty cycle is directly proportional with

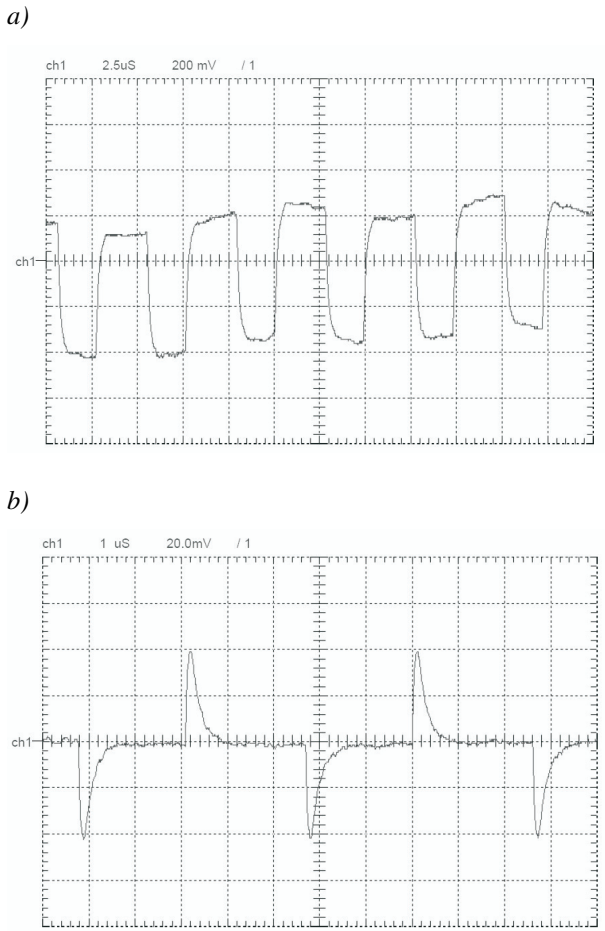

Fig. 3. Curve of the PWM signal, a) without the RC element b) RC element C=82 pF, R=1 kΩ.

the instantaneous value of the audio signal. The comparator then drives a MOS gate driver which in turn drives a pair of high-power switches. This produces an amplified replica of the comparator's PWM signal. The output filter removes the high-frequency switching components of the PWM signal and recovers the audio information that the speaker can use.

Fig. 3a shows the curve of the signal without inlet RC element, while Fig. 3b illustrates the curve of the signal with connected inlet RC element. The signal was generated by means of a D-class amplifier, type TPA2001D1, with PWM signal frequency set to 204.8 kHz. Fig. 3a shows a clear penetration of the signal with a frequency of 50Hz.

Yet if we consider that the modulation voice information is contained in each pulse length, it will be possible to make an easy derivation of inlet pulses using the derivative RC element that simultaneously functions as an efficient high-pass filter – see Fig. 3b. In this way, the disturbing component at 50Hz frequency is removed, and the information system receiver has only to restore the pulses using the received positive (pulse start) and negative derivative peaks (pulse ends). Fig. 4 shows a block diagram of the PAN receiver wiring using PWM modulation.

The inlet flat spot is connected to the RC derivative circuit inlet. The outlet is led to a pair of comparators; one comparator detects the positive derivative peaks, while the other detects

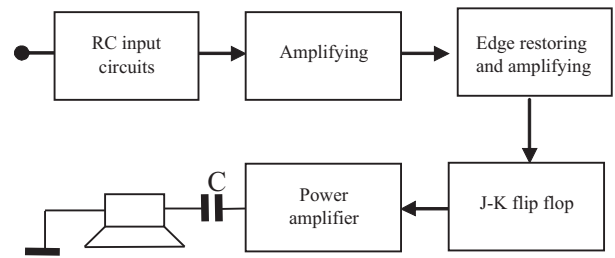

Fig. 4. Block diagram of PAN receiver wiring.

negative ones. Using appropriately selected reference thresholds, it is possible to set the required receiver's sensitivity. The comparators outputs are led to RS inlets of the toggle circuit that restores the pulse lengths and, in terms of impedance, adapts the related power stage through which the passive low-pass filter energizes the power of the loudspeaker inside the earphone. The entire receiver of the information system is supplied by two NiMh batteries equipped with circuits for charging.

The information content of data is saved via a USB interface in an acoustic module in WAV format. Sampling frequency is 16 kHz, and the data feature a 16-bit resolution. The acoustic module converts the saved data to an audio signal using a D/A converter and a class D amplifier. In the HF modulator input are a low-pass filter to limit the frequency band of the audio signal above 7 kHz, and a modulator to create a modulated carrier frequency of 204.8 kHz through the audio signal.

A touch on the area will result in a slight decrease in the output signal magnitude. The touch detector evaluates this change and generates a starting signal to the acoustic module. This ensures that the information content from the acoustic module will be generated from its beginning, i.e. from the moment the area is touched. The entire information system transmitter is supplied by a galvanically separated 12 V power source.

A person with vision impairment analyses the 3D scene by touch and obtains a comprehensive representation of the layout of objects. Their subsequent orientation in the environment will thus be easier and more comfortable. The recording of data onto acoustic modules in another language is very easy, and the model can be used by foreign visitors to assist their orientation in the given environment.

Fig. 5. shows a photograph of the receiver with standard earphone and an auricle clip. To enable orientation in an unknown environment, it is not necessary to create a 3D relief model. The information system receiver can, for example, be installed in a door. The contact area is then located on the door handle. Having touched the door handle, the person equipped with the information system receiver receives information as to what authority, member of staff or departmental office is situated behind the given door. It is easy to install such information system on e.g. handrails, at stopping points on public transport systems, entrance doors of buildings or on exhibits.



Fig. 5. Photograph of the information system.

IV. NAVIGATION VIA MAGNETIC PICTOGRAMS

There are now numerous possibilities for guiding people with visual impairment [9]–[16]. The concept of the Dinasy's guidance system was based on creating guidance and warning lines – pictograms, made of neodymium permanent magnets. This situation is shown in Fig. 6.

This design solution is advantageous for several reasons:

- easy integration into the existing infrastructure,
- no power supply required,
- function is guaranteed even if pictograms are snowed-in or under a layer of ice,
- several basic warning or guidance pictograms can be created by a combination of magnetic poles.

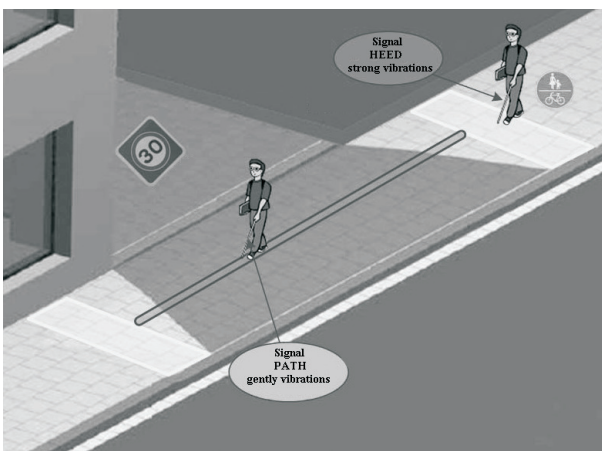
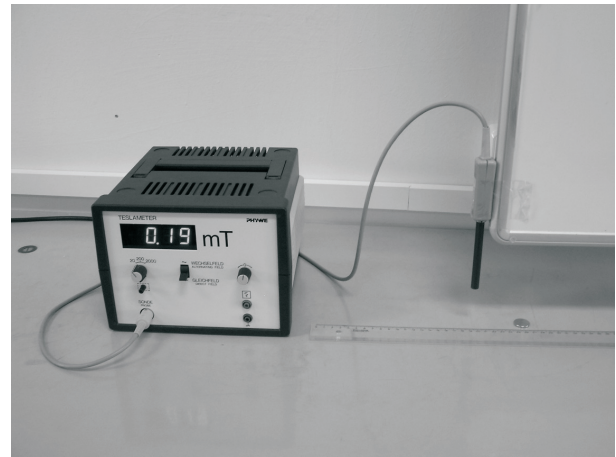

Fig. 6. Use of magnetic pictograms for orientation and guidance.

a)



b)

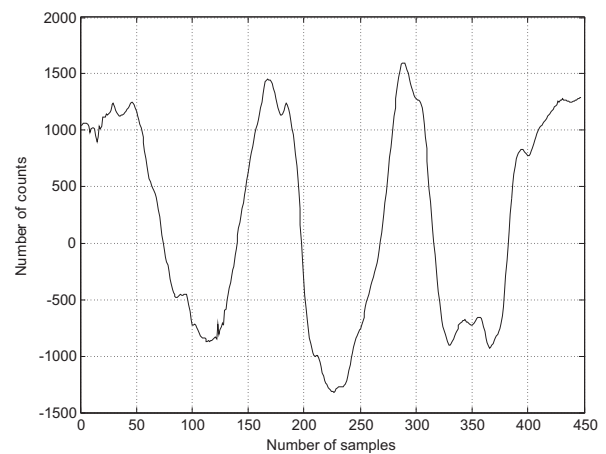

Fig. 7. Measurement of the magnetic induction of a permanent magnet (a) typical characteristics of values measured by the magnetometer (b).

However, the relatively easy creation of magnetic pictograms is counterbalanced by difficulties with the detection and analysis of the signal type. The basic difficulty consists in the fact that orientation sticks are used by people with visual impairment for both swinging and sliding techniques. In other words, the orientation stick may be inclined from 0° up to 45° and the movement around the pictogram may be both longitudinal and transversal.

First, magnetic induction values were measured by a Tesla-meter for different types of neodymium magnets and for different vertical and horizontal distances, as shown in Fig. 7a. The magnetic induction values ranged from 30 μT to 250 mT depending on the distance of the magnetometer from the magnet. The lowest values of magnetic induction are almost equal to the amount of the Earth's magnetic field. The typical characteristics of values measured by the magnetometer, located at the end of the orientation stick, are shown in Fig. 7a.

It is apparent from the characteristics in Fig. 7b. that the measurement of magnetic induction values of permanent magnets located on the ground is largely influenced by the Earth's magnetic field. Also, it is apparent that the magnetic induction amount is influenced by both the stick's orientation

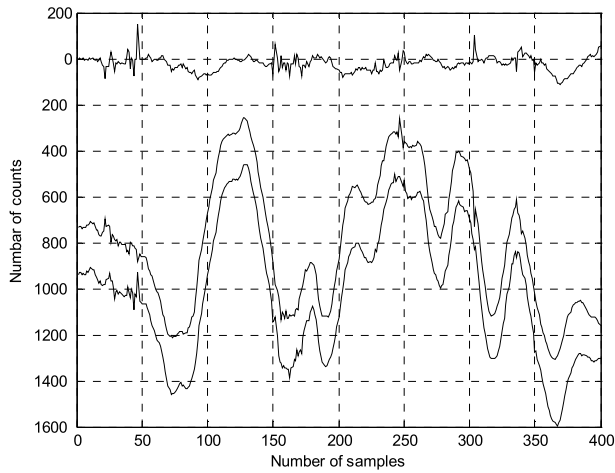

Fig. 8. Typical curve of measured values of the compensated magnetometer.

towards the Earth’s magnetic field and the stick’s inclination towards the surface.

To eliminate the undesirable values of magnetic induction that depends on the orientation of the cane to the magnetic pole of the Earth, especially when the toggle device is used, the application of two independent, spatially separated magnetometers has proved to be an efficient solution. One magnetometer shall be placed at the end of the orientation cane, while the other shall be displaced by a distance of 43 cm. The measured values of magnetic induction shall be deducted one from the other. The resulting values of measured magnetic induction will, only to a very small extent, depend on both the orientation of the cane to the Earth’s magnetic pole and the incline to the Earth’s surface. Fig. 8 illustrates the curve of the magnetometer’s values for the rotation of the orientation cane 0-360°, with a cane incline of 0°-45°.

For the necessary detection and recognition of the orientation of the placed permanent magnet, the cane inline has proved to be a more serious problem.

With respect to its small mechanical dimensions, the magnetic field sensor is sensitive to the orientation cane incline. At the application of a toggle device, the practical values of incline equal approx. 45°; when a sliding device is used, they are less than 15°. The magnetometer’s sensitivity to the orientation cane incline is documented by measurements the results of which are shown below. Fig. 9a shows a curve of magnetometer’s values for one permanent magnet (north) and a cane incline of 0°, while Fig. 9b shows the values for a cane incline of 45°, with the same magnet orientation.

Fig. 10a shows a curve of the magnetometer’s values for one permanent magnet (south) and a cane incline of 30°, while Fig. 10b illustrates a cane incline of 45° with the same magnet orientation.

Referring to the measured curves of magnetic induction as shown in Fig. 9 through 10, it is clear that the detection of a permanent magnet presence at an orientation cane incline of 0° is trouble-free, but at a cane incline greater than 30° a transient opposite value almost equalling 30% of the maximum value occurs at passage.

Since it is necessary that the detection distance between the

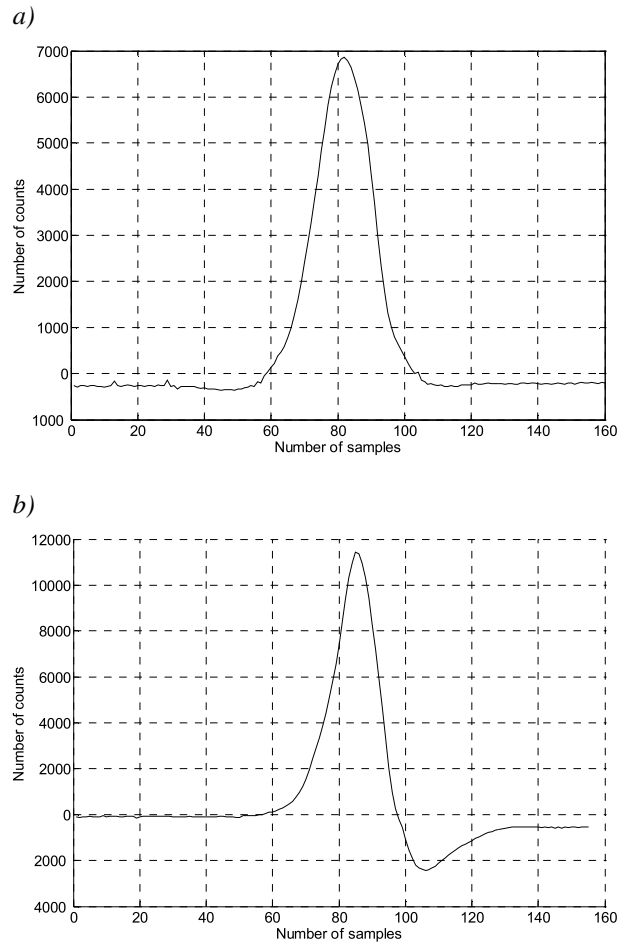

Fig. 9. Typical curve of measured magnetometer values, north, at a cane incline of 0° (a) and 45° (b).

placed permanent magnets and the orientation cane tip be at least 15cm (6 inches), the detection algorithm shall adaptively change the detection thresholds of both values of magnetic induction in accordance with the instantaneous incline of the orientation cane.

Based on the practical measurements, an analysis of disturbing influences, and the practical experience of users with visual impairment, the block diagram of the orientation cane electronic wiring has been prepared – see Fig. 11.

The detection element designed was a module of a sensitive dual-axis digital magneto-inductive magnetometer with an PNI-ASIX control circuit and a control microcontroller that performs the digital measurement of magnetic induction, detection and identification of the type of pictogram, and generating the control signal for the small vibration motor. The type of vibration generated warns the user of a possible collision on his/her route. The adaptive algorithm of detection and identification of the type of magnetic pictogram efficiently suppresses the influence of magnetic field changes on the orientation stick and, at the same time, adaptively sets the amount of the decision threshold depending on the stick inclination.

Another problem to have arisen from the practical experience of the cane users with visual impairment consists in the principle of switching the orientation cane electronics.

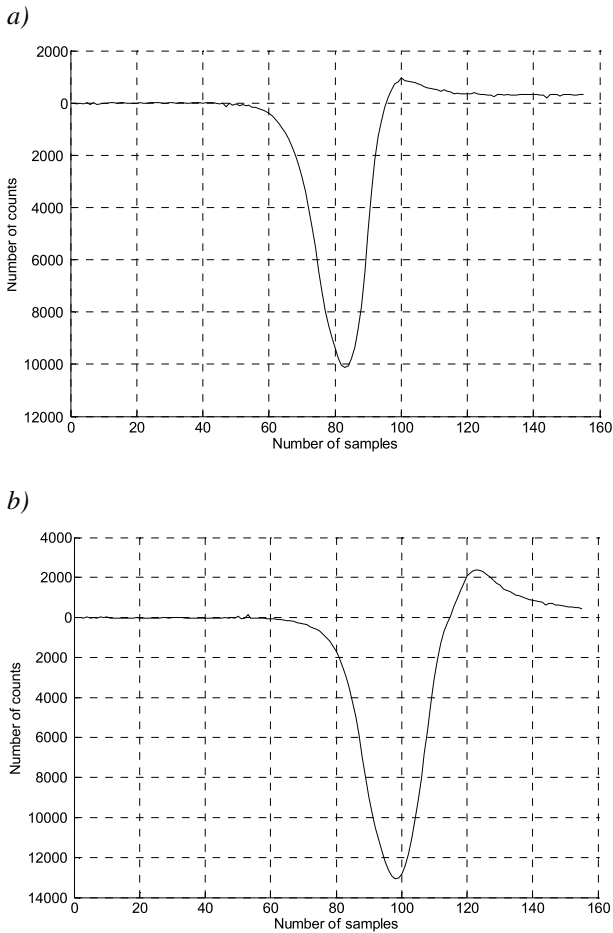

Fig. 10. Typical curve of measured magnetometer values, south, at a can incline of 30° (a) and 45° (b).

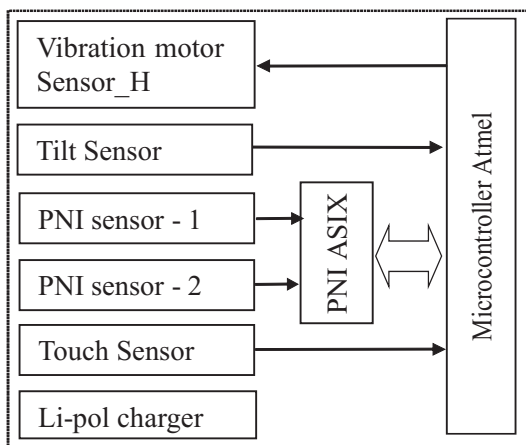

Fig. 11. Block diagram of the orientation cane electronic wiring.

It would happen that the user either switched off the cane inadvertently, or let it switched-on for a period of several days so that upon application the battery was already discharged. Therefore, a module of capacitance touch sensor has been integrated into the orientation cane electronics to ensure that the cane electronics are automatically switched on upon the cane being grasped by hand. This solution has facilitated and simplified users' handling of the orientation cane.



Fig. 12. Two-axis digital magnetometer module.

In the handle of the orientation stick there is a small vibration motor and a Li-Ion battery with an automatic charging system. All electronic equipment is designed and made in such a way that it can be inserted and mechanically fixed in the standard orientation stick with an inner diameter of 8.2 mm.

A photograph of the magnetometer module, including all auxiliary circuits, is shown in Fig. 12.

V. CONCLUSION

The paper has shown that the PAN principle can further be developed and that there are several possibilities for its practical application. In the period to come, it is necessary to focus on the complete digitalization of the entire system, and thus to ensure, in particular, the easy selection of the language for the information content. Future results achieved in this area will be disclosed on a regular basis.

Next the article describes the principle of a possible guidance system for people with visual impairment using magnetic pictograms. This guidance system works in cooperation with

the Dinasy information system. The concept of the guidance system shown in Fig. 6 is protected by the Industrial Property Office.

REFERENCES

- [1] T. G. Zimmerman, "Personal Area Networks (PAN): Near-Field Intra-body Communication," Master's thesis, MIT Media Laboratory, 1995.
- [2] United States Patent Application Publication, *Method and Apparatus for Transmitting Power and Data Using the Human Body*. Microsoft Corporation, US 6,754,472, 2004.
- [3] K. Hachisuka, "Development and Performance Analysis of an Intra-Body Communication Device," in *Proceedings of 12th International Conference on Solid State Sensors, Actuators and Microsystems*, Boston, June 2003, pp. 1722–1725.
- [4] M. Wegmueller, "Measurement System for the Characterization of the Human Body as a Communication Channel at Low Frequency," in *27th Annual International Conference of the Engineering in Medicine and Biology Society*, 2005, pp. 3502–3505.
- [5] K. Fujii, "Study on the Transmission Mechanism for Wearable Device Using the Human Body as a Transmission Channel," *Institute of Electronics, Information and Communication Engineers Transactions on Communications*, vol. E88-B, no. 6, pp. 2401–2410, June 2005.
- [6] M. Sun, "How to Pass Information and Deliver Energy to a Network of Implantable Devices within the Human Body," in *Proceedings of the 29th Annual International Conference of the IEEE EMBS Cité Internationale*, Lyon, France, August 23–26 2007, pp. 5286–5289.
- [7] T. Nagatsuma and M. Shinagawa, "Photonic Measurement Technologies for High-Frequency Electronics," *NTT Technical Review*, vol. 14, no. 6, pp. 12–24, 2002.
- [8] M. Shinagawa, "Development of Electro-Optic Sensors for Intra-Body Communication," *NTT Technical Review*, vol. 2, no. 2, pp. 6–11, 2004.
- [9] A. D. Heyes, M. Durinck, and A. Beaton, "The Sonic Pathfinder: Developments and Preliminary Field Trial Results," in *Orientation and Mobility of the Visually Impaired*, Neustadt-Noy and Schiff, Eds. Jerusalem: Helliger Publishing Co., 1988.
- [10] S. Helal, F. Moore, and B. Ramachandran, "An Integrated Navigation System for Visually Impaired and Disabled," in *Proceedings of the 5th International Symposium on Wearable Computer (ISWC'01)*, ETH, Zurich, Switzerland, October 2001.
- [11] M. Carter, H. Jin, M. Saunders, and Y. Ye, "Spaseloc: an Adaptive Sub-problem Algorithm for Scalable Wireless Sensor Network Localization," *SIAM Journal on Optimization*, vol. 17, no. 4, pp. 1102–1128, 2006.
- [12] N. Bulusu, J. Heidemann, and D. Estrin, "Gps-less Low-cost Outdoor Localization for Very Small Devices," *IEEE Personal Communications Magazine*, vol. 7, no. 5, pp. 28–34, 2000.
- [13] T. Grundmann, R. Eidenberger, R. D. Zoellner, X. Zhixing, S. Ruehl, J. M. Zoellner, R. Dillmann, J. Kuehne, and A. Verl, "Integration of 6D Object Localization and Obstacle Detection for Collision Free Robotic Manipulation," in *IEEE/SICE International Symposium on System Integration*, 2008.
- [14] J. Nicholson, V. Kulyukin, and D. Coster, "ShopTalk: Independent Blind Shopping Through Verbal Route Directions and Barcode Scans," *The Open Rehabilitation Journal*, vol. 2, pp. 11–23, 2009.
- [15] J. Ishikawa and Y. Hyodo, "Hopefulness and Problems of Accessible GPS System for the Blind Walkers," *IEICE*, vol. 104, no. 637, 2005.
- [16] *A Guidance System for Persons with Vision Impairment, 2009-21101, reg. No.:19729*. Prague, Czech Republic: B-support, s.r.o., Industrial Property Office, 2009.