

Multi-Channel System for Sound Creation in Open Areas

Andrzej GOŁAŚ, Katarzyna SUDER-DEBSKA

AGH University of Science and Technology

al. A. Mickiewicza 30, 30-059 Kraków, Poland; e-mail: suder@agh.edu.pl

(received March 31, 2011; accepted July 2, 2012)

There are typically two systems in use for sound reinforcement in open areas: the central, “wall of sound” system with speakers localized at the sides of the stage, and the zone system, in which additional speakers are introduced to obtain a uniform sound pressure level throughout the area of listening. In the past two decades the line array systems gained great popularity. The main purpose of their use is to obtain a uniformly distributed sound level throughout the listening area in order to achieve good speech intelligibility. The present paper aims to present an alternative and original method of sound reinforcement in open areas which is in contrast to the above solutions. This new method allows achieving a uniformly distributed sound pressure and good speech intelligibility in the area of interest, and also allows to gain spatial sound impression that accompanies sound reproduction in concert halls. Another advantage of the proposed system is the reduction of the sound level outside the area of interest, i.e. reduction of the noise level outside the area of listening.

Keywords: sound creation system, open area, spatial impression, noise, geometrical method, inverse image source method.

1. Introduction

During the sound reinforcement in open areas with so called “wall of sound”, there are two ways to create the acoustic field: in small areas, by using high power loudspeaker sets localized centrally (on the stage) and, for large areas, by using the zone sound system (HOJAN, 2003; ISHIZAWA *et al.*, 1998; TOOLE, 2008]. An alternative method is the use of line array systems which, compared to the “wall of sound”, provide a more uniform distribution of the acoustic field across the entire area of listening (URED, 2001). The main purpose of their use is to obtain a uniformly distributed sound level throughout the listening area in order to achieve good speech intelligibility but other parameters describing the properties of the acoustic field in the object are ignored.

In the case of listening in concert halls and opera houses, many authors (ANDO, 1985; BERANEK, 1996; BRADLEY, 1991; BRADLEY *et al.*, 2000; HIDAKA *et al.*, 2000; KULOWSKI, 2007; KUTTRUFF, 2009; LONG, 2006; MARSHALL, BARRON, 2001) draw attention to a number of parameters, such as the “Clarity” group parameters, the parameters relating to speech intelligibility on the analysed object, or the “Lateral Sound” group parameters, very important when listening to music.

Unfortunately, in the case of outdoor concerts, because of the dominance of the direct sound from the sound sources, particularly the spatial sound impressions are considerably limited (MEYER, 2009). It is this factor that has led the authors to propose a sound system for open areas that would allow obtaining simultaneously a uniform sound reinforcement in the area of interest, good speech intelligibility, and spatial sound impression similar to that achieved in concert halls.

It should also be noted that in the case of sound reinforcement in open areas, a high noise level is emitted outside the area of listening. It is usually very inconvenient to the outsiders. The proposed system for sound reinforcement in open areas allows a considerable reduce of that noise.

Formulating the objective of the research

The objectives of the present paper were (Fig. 1):

- 1) to build a multi-channel sound creation system in open area;
- 2) to reduce noise level emitted outside the open area of sound reinforcement.

The object of interest are squares and market places in cities (limited slightly by the surrounding buildings)

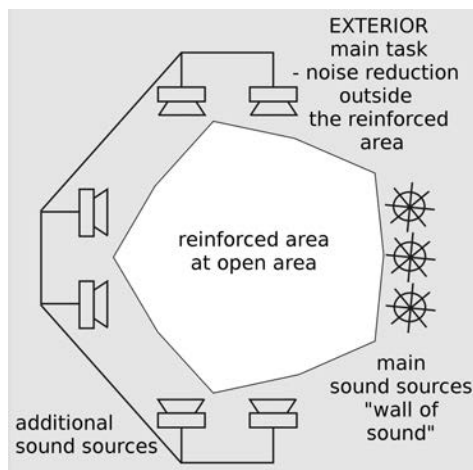

Fig. 1. Schematic diagram of a multi-channel sound creation system in an open area.

in which various artistic events are organised, concert shells in parks, etc., further referred to as open areas. The idea behind the concept was to create, in an open area, the acoustic field with properties similar to the ones of the acoustic field in a good concert hall. The created acoustic field was supposed to meet the following quality criteria (MECHEL, 2008):

1. SPL (Sound Pressure Level) [dB];
2. D Definition [%] – parameter characterizing speech intelligibility;
3. C_{50} Clarity [dB] – parameter characterizing speech intelligibility;
4. C_{80} Clarity [dB] – parameter characterizing music reproduction clarity;
5. LF Lateral Energy Fraction [%] – parameter characterizing spatial sound impression;
6. LFC Lateral Energy Fraction Coefficient [%] – parameter characterizing spatial sound impression;
7. STI Speech Transmission Index – parameter characterizing speech intelligibility;
8. AL_{Cons} Articulation Loss of Consonants [%] – parameter characterizing speech intelligibility, referring to the loss of consonant intelligibility.

The above-mentioned quality criteria on the analysed object should have the following values (based on e.g. (KULOWSKI, 2007):

1. SPL – assuming that for the open area, the background noise level may reach ca. 50 [dB], whereas the sound pressure level in the area of listening should be at least 75 [dB], and distribution of this parameter should be even enough for the difference between the highest and lowest SPL value not exceed 6 [dB];
2. Definition – above 70 [%], C_{50} – $\geq +3$ [dB], STI – at least 0.6, AL_{Cons} – maximum 10 [%], for the speech reception to be at least good;

3. C_{80} from the range -5 [dB] \div $+9$ [dB], or slightly above $+9$ [dB], for the clarity of music to be at least of a medium quality;
4. LF and LFC – in the range 10 [%] \div 25 [%].

Sound system description

To generate an acoustic field with the properties described above, a multi-channel sound system was utilised. This system consists of the main and additional sound sources. The sound emitted by instruments without any amplification, as well as loudspeaker sets on the stage as the main and central sound sources can be used. Additional sound sources are extra loudspeakers which simulate the sound reflected from walls, as it occurs indoors.

The system should ensure in the examined area the sound quality equivalent to that achieved in closed rooms with good acoustic properties. It should ensure values of the sound parameters equally good to ones in good concert halls, and minimise the noise outside the area of listening. The image source method was used in an inverse order (GOŁAŚ, SUDER-DEBSKA, 2010) to synthesise the structure of the sound sources distribution in the open area, further referred to as the inverse image source method. In general, the method is to assume the desired properties of the acoustic field on the object, and the distribution and parameters of the sound sources ensuring the effect which is as close to the expectation as possible.

Inverse Image Source Method

The image source method is one of the geometrical methods which, for a specific area with determined geometry and acoustic parameters, and for a predefined localization of the sound sources, allows to determine the parameters of the acoustic field. The idea of the Inverse Image Source Method is presented in Fig. 2. The Inverse Image Source Method involves an innovative use of the conventional image source method to solve the inverse problem. It means that, on the examined object (open area), the type of the desired

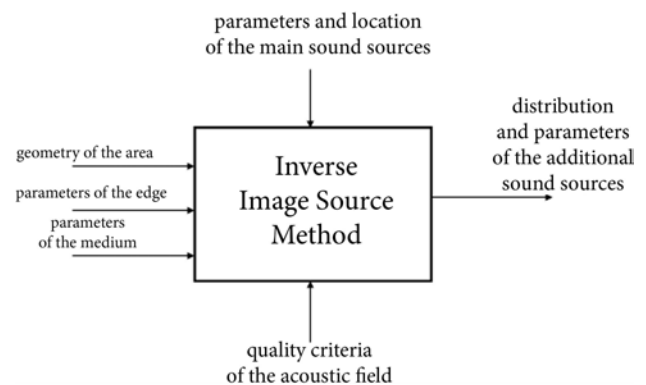

Fig. 2. Idea of the Inverse Image Source Method.

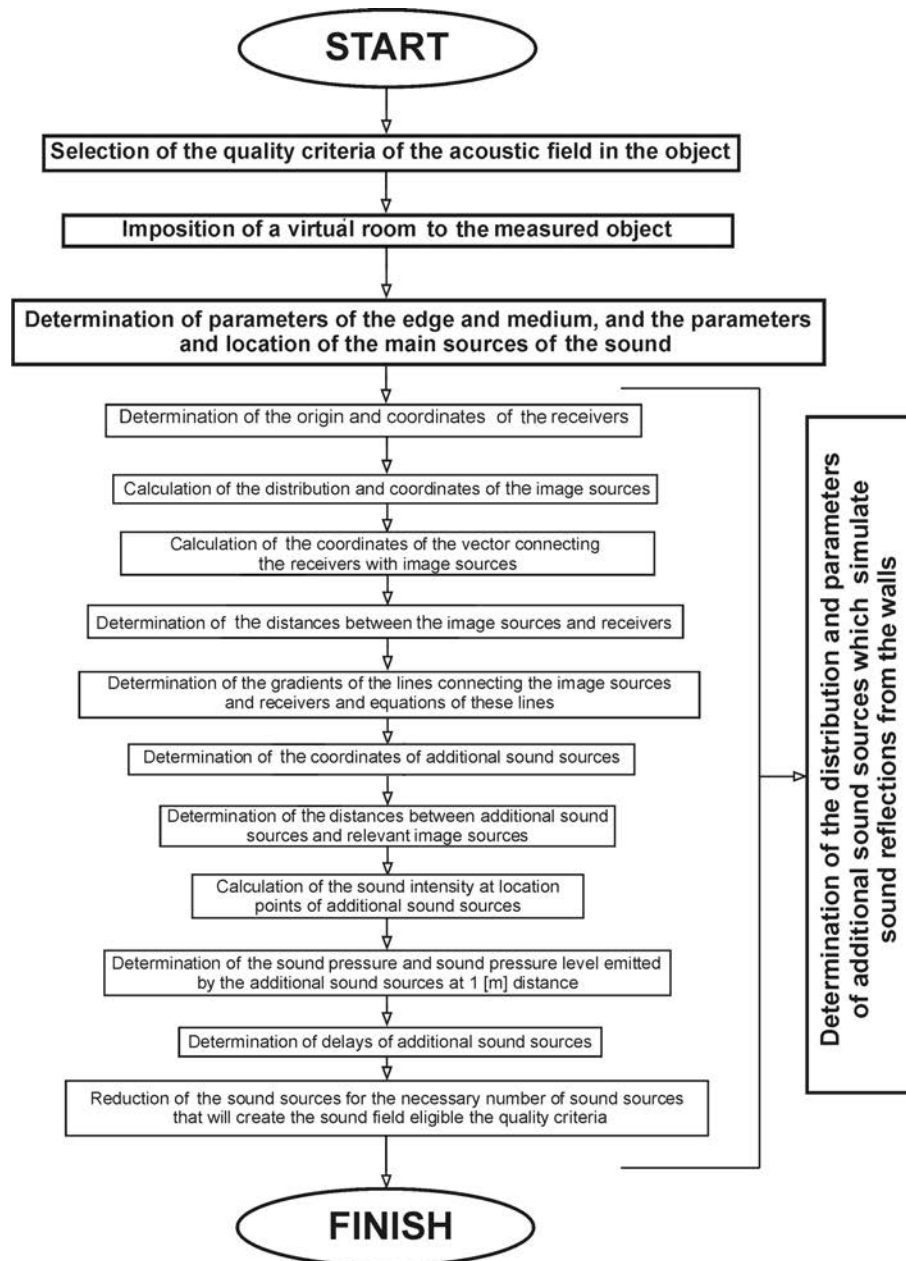

Fig. 3. Algorithm of the Inverse Image Source Method.

acoustic field, its acoustic parameters, is initially assumed, and then, based on the inverse image source method, the distribution of additional sound sources which surround the reinforced area, their power, and delays are determined in such a way that the acoustic field with the assumed properties is created. These additional sound sources imitate sound reflections from the wall. The algorithm of the inverse image source method (Fig. 3) can be briefly described as follows:

- 1) determining the desired values of acoustic parameters;
- 2) determining acoustic parameter distribution on the examined object for a conventional sound system type;
- 3) determining, based on the inverse image source method, the distribution and parameters of additional sound sources creating the acoustic field on the object with the properties as close to the predefined quality criteria as possible.

2. Analysing the central system

Numerical simulations of various types of the central sound system were performed based on the EASE software.

An open area dimensioned 24 [m] × 32 [m] was assumed as the analysed object. For the examined area, asphalt surface, air temperature 20 [°C], and humidity

60 [%] were assumed. Simulation tests were performed for the conventional central system with loudspeakers localized at the sides of the stage. Figure 4 shows the model of the analysed object.

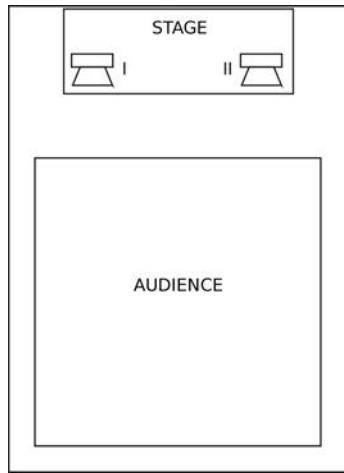

Fig. 4. Numerical model of the open area for the central sound system

The conventional central sound system was analysed in 15 configurations: 12 times for various types of loudspeakers placed individually at the sides of the stage, and 3 times for 4 loudspeakers of various types placed at the sides of the stage, with the speakers operating at the sound power level at the level about 100 [dB] ÷ 115 [dB] in all the cases (there are mean *SPL* values obtained during concerts and events). Simulation results, such as mean values of the acoustic parameters are given in Table 1.

Figure 5 shows the distribution of the *SPL* parameter for two Community WET315–94 speaker sets localized at the sides of the stage. Figure 6 shows the distribution of the *LF* parameter for the system as above.



Fig. 5. *SPL* parameter distribution for the Community central sound system.

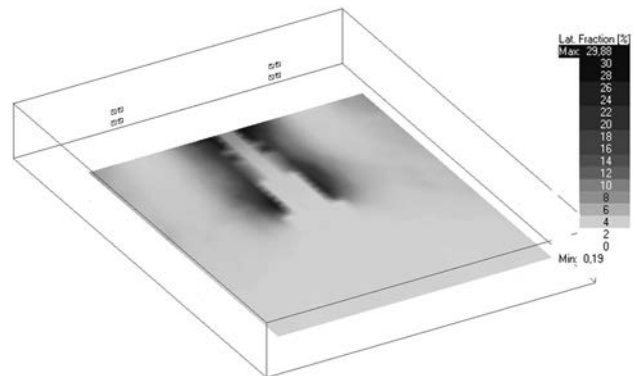

Fig. 6. *LF* parameter distribution for the Community central sound system.

Table 1. Simulation results for the reinforced area.

System	<i>SPL</i> [dB]	Definition [%]	C_{50} [dB]	C_{80} [dB]	<i>LF</i> [%]	<i>LFC</i> [%]	AL_{Cons} [%]	<i>STI</i>
2 x EAW KF750F	115.4	99.9	40.4	50.1	2.3	3.2	1.0	0.99
2 x Community WET315–94	98.8	99.9	40.9	51.9	2.9	4.1	1.0	0.99
2 x Dynacord VariLine VL262	98.6	99.9	40.2	51.9	5.6	8.0	1.0	0.98
2 x HK Audio VT115X	100.6	99.9	40.4	52.6	3.8	5.5	1.0	0.99
2 x JBL PRO AM4215/64P	103.0	99.9	40.9	56.8	3.5	5.1	1.0	0.99
2 x MERIDIAN DSP5500	94.9	99.9	40.4	51.9	7.7	10.8	1.0	0.98
2 x Meyer Sound UPA-2P	111.2	99.9	40.2	53.3	4.2	5.8	1.0	0.99
2 x Peavey IMP652S	94.4	99.9	40.6	47.0	7.1	10.0	1.0	0.98
2 x Proel NEXT15HP	104.9	99.9	40.9	50.2	4.1	5.9	1.0	0.99
2 x Renkus – Heinz STX4–94	109.4	99.9	40.6	52.5	4.4	6.5	1.0	0.99
2 x Tannoy T300	105.3	99.9	40.7	54.7	4.4	6.4	1.0	0.99
2 x Yamaha F15	99.0	99.9	40.5	54.2	4.1	6.0	1.0	0.98
8 x Community WET315-94	104.8	99.9	40.0	56.0	3.2	4.6	1.0	0.99
8 x JBL PRO AM4215/64P	108.9	99.9	39.5	51.5	3.8	5.7	1.0	0.99
8 x Renkus – Heinz STX4–94	115.3	99.9	39.4	50.9	4.8	7.2	1.0	0.99

According to the simulation results, in all configuration cases the speech intelligibility is excellent, which is not surprising with the direct sound from the main sources at the sides of the stage dominating on the object. Yet, the clarity parameter in music perception is exceeded (high C_{80} values). Spatial impressions are very poor as well, as indicated by the LF and LFC values of the order of a few percent. The difference is noticeable only in the case of the SPL parameters, it is, however, dependent on the parameters of individual loudspeakers. Consequently, from the analysed configurations, the highest SPL values can be achieved using EAW loudspeakers, and the lowest from Peavey loudspeakers.

3. Multi-channel sound creation system in the open area

Numerical simulations of a multi-channel sound creation system were performed based on the EASE software.

An open area dimensioned 24 [m]×32 [m] was assumed as the analysed object. For the examined area, asphalt surface, air temperature 20 [°C], and humidity 60 [%] were assumed. So, it was an object identical to that analysed for the central sound systems. The difference is that the new sound system was used in the case of the multi-channel sound creation system, composed of the main sources on the stage and additional, delayed, sources of sound surrounding the auditorium, and their sound power levels reduced adequately in relation to the sound power levels of the main sound sources. The main sound sources are two loudspeakers placed at the sides of the stage, with 102 [dB] sound power level each, and the parameters of the additional sound sources are given in Table 2. A schematic distribution of the sound sources is given in Fig. 7, where I and II are the main sound sources. The multi-channel sound creation system described was built based on the inverse image source method.

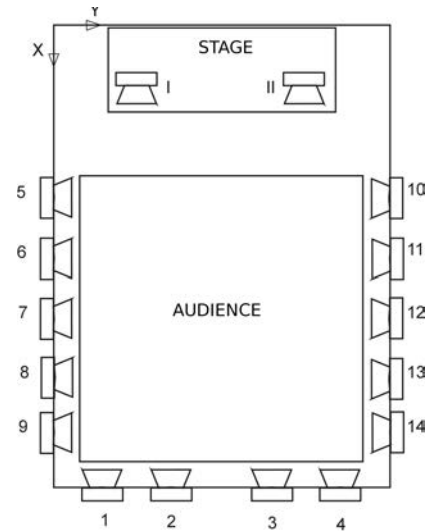

Fig. 7. Schematic diagram of the sound sources distribution for the multi-channel system for sound creation in open areas (based on the Inverse Image Source Method).

For the object described above in the EASE 4.3 software, the acoustic field was simulated using geometrical methods with taking into account the interference between individual loudspeakers (“All source contributions are added first in a complex manner and then the resulting complex sum squared. This retains all the phase effects such as cancellations and additions” (EASE, 2009)).

Mean values of the acoustic parameters described in the introduction obtained in the area of interest with the proposed multi-channel sound creation system are given in Table 3.

Table 2. Additional sound sources parameters which simulate the sound reflected from the walls.

source number	coordinates [m]	sound power level [dB]	delay [ms]
1	(32.00; 5.20; 1.55)	84.5	88
2	(32.00; 9.05; 1.55)	83.5	104
3	(32.00; 14.95; 1.55)	83.5	104
4	(32.00; 18.80; 1.55)	84.5	88
5	(9.05; 0.00; 1.55)	91.3	40
6	(13.05; 0.00; 1.65)	82.5	110
7	(17.00; 0.00; 1.55)	88.5	55
8	(21.10; 0.00; 1.55)	82.0	118
9	(23.00; 0.00; 1.50)	86.5	70
10	(9.05; 24.00; 1.55)	91.3	40
11	(13.05; 24.00; 1.65)	82.5	110
12	(17.00; 24.00; 1.55)	88.5	55
13	(21.10; 24.00; 1.55)	82.0	118
14	(23.00; 24.00; 1.5)	86.5	70

Table 3. Mean values of the acoustic parameters achieved in the reinforced area with the multi-channel sound creation system (with Visaton BG17 speakers).

system	SPL [dB]	D [%]	C_{50} [dB]	C_{80} [dB]	LF [%]	LFC [%]	AL_{Cons} [%]	STI
multi-channel sound creation system	76.9	88.3	10.5	15.9	13.1	17.8	1.9	0.83

Figure 8 and Fig. 9 present, respectively, the distribution of SPL and LF parameters in the reinforced area for the multi-channel system for sound creation in open areas.

According to the performed simulations, the sound pressure level in the area of interest is relatively uniform – in almost 90 [%] of the area, the SPL differences are below 6 [dB], speech intelligibility is at a very good/excellent level, as indicated by the values of Def-



Fig. 8. Distribution of the *SPL* parameter in the reinforced area for the multi-channel system for sound creation in open areas.

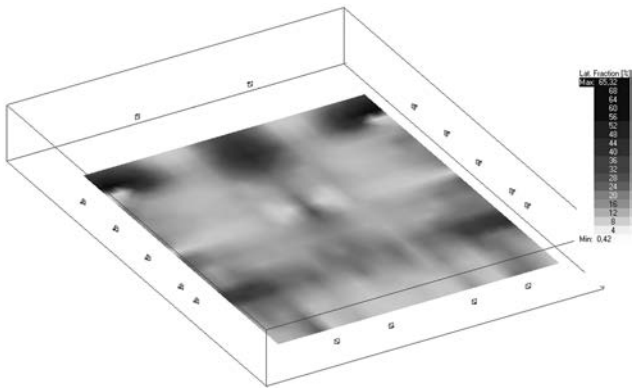

Fig. 9. Distribution of the *LF* parameter in the reinforced area for the multi-channel system for sound creation in open areas.

inition – over 85 [%], C_{50} – over 10 [dB], STI – over 0.8, AL_{Cons} – less than 2 [%]. Clarity in music perception is also at a satisfactory level, as indicated by the C_{80} parameter, and much better than that in the case of the central sound system. The proposed solution allowed to achieve spatial impression as in rooms, which is indicated by the LF and LFC values, where over 80 [%] of the area exhibits values of the desired range.

4. Noise outside the reinforced area

As already mentioned, in the case of concerts taking place in market places, squares etc., the problem of sound emitted outside the reinforced area emerges. Particularly, in the case of events lasting several days, the noise may be very strenuous to persons staying nearby. Therefore, according to the authors, it is essential to reinforce the sound in open areas in such a manner so that the sound emitted outside was as quiet as possible. Therefore, the area dimensioned 84 [m] × 92 [m] in the centre of which the open area of interest is located (the sound level was analysed in the area surrounding the object, in the radius exceed-

ing 40 metres) was also analysed. The analysis was performed for two sound reinforcement configurations, the central sound system for EAW KF750F loudspeakers, due to the fact that they emitted the highest noise level within the reinforced area, and for Peavey IMP652S loudspeakers, since they emitted the lowest noise level, and the third configuration was the proposed multi-channel system for sound creation in open areas. Table 4 presents the simulation results.

Table 4. Differences between the mean values of *SPL* parameter inside and outside the reinforced area for the three analysed configurations of sound system.

system	ΔSPL [dB]
2 x EAW KF750F	11
2 x Peavey IMP652S	10
multi-channel sound creation system	14

Figure 10 presents the distribution of the *SPL* parameter outside the reinforced area for the multi-channel system for sound creation in open areas.

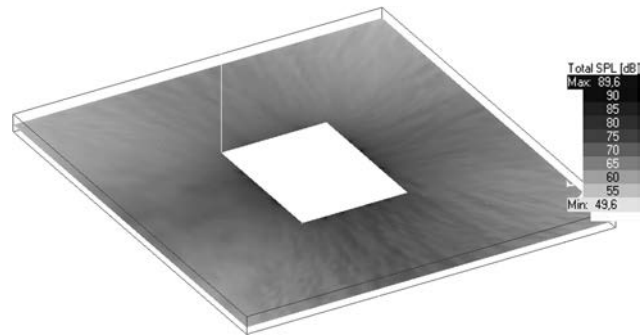

Fig. 10. Distribution of the *SPL* parameter outside the reinforced area for the multi-channel system for sound creation in open areas.

Noticeably, the highest differences between the mean values of the *SPL* parameter inside and outside the reinforced area can be achieved while using the multi-channel system for sound creation in open areas. While using the central loudspeakers configuration, the noise level outside the area is very high and clearly depends on the power output of the installed speakers. The differences between the values of noise level from the multi-channel system for sound creation in open areas and the noise level from the central systems are of the order of some over twenty decibels with the advantage of the multi-channel system. Furthermore, it has to be stressed that for the multi-channel system for sound creation in open areas the noise level emitted in the distance of around 40 metres from the reinforced area is close to the background noise, whereas for the central system the noise level is from 69 [dB] to even above 80 [dB].

5. Summary and conclusions

As the analysis carried out indicates, the proposed multi-channel system for sound creation in open areas allows to achieve a relatively uniform sound pressure level across the area of interest and good/satisfactory clarity of sound for both music and speech with a good/very good mark. A considerable improvement of spatial impressions is noticeable after utilising the multi-channel sound system – when used, the *LF* and *LFC* parameters are within the range recommended for concert halls. Without the system, the *LF* and *LFC* parameters are of several percent values, which means they are too low. As it could have been expected, after introducing additional loudspeaker sets surrounding the listener, the intelligibility of speech decreased, but the *STI* and *AL*_{Cons} parameters prove that it still remains at a good/very good level.

As a result of analysis performed outside the area, it can be stated that the use of the proposed multi-channel system for sound creation in open areas may allow reduction of the noise emitted outside the area. In the least favourable case, the reduction is around 20 [dB], whereas in the best case, the reduction may be even above 35 [dB]. It is of essential importance, especially considering the fact that for the proposed system, only within 40 metres from the reinforced area, the noise level achieved is below 50 [dB], so its value is close to the background noise level.

To sum up, it should be concluded that the multi-channel system for sound creation in open areas may fulfil the objectives assumed, namely, it can create, within the area of interest, an acoustic field with the properties close to that of rooms (closed spaces) and, at the same time, allow to reduce the noise outside the reinforced area.

The proposed system exists only as a computer model at the moment. Using some components of the multi-channel system (CIESIELKA, 2009) (e.g. loudspeakers, amplifiers, signal processors), an attempt was made to build a true multi-channel system for sound creation in open areas based on the inverse image source method. First preliminary studies of this system in a measured object and results of the measurements confirm the results obtained through the simulations (GOŁAŚ *et al.*, 2011).

References

1. ANDO Y. (1985), *Concert Hall Acoustics*, Springer-Verlag.
2. BERANEK L. L. (1996), *Acoustics and musical qualities*, The Journal of the Acoustical Society of America, **99**, 5, 2647–2652.
3. BRADLEY J. S. (1991), *A comparison of three classical concert halls*, The Journal of the Acoustical Society of America, **89**, 3, 1176–1192.
4. BRADLEY J. S., REICH R. D., NORCROSS S. G. (2000), *On the combined effect of early- and late-arriving sound on spatial impression in concert halls*, The Journal of the Acoustical Society of America, **108**, 2, 651–661.
5. CIESIELKA W. (2009), *A multi-channel system for sound control in the open space*, Archives of Acoustics, **34**, 4, 559–577.
6. EASE 4.3 User's Guide and Tutorial (2009), Acoustic Design Ahnert, Germany.
7. GOŁAŚ A., SUDER-DĘBSKA K. (2010) *Acoustic field synthesis based on inverse image source method*, Proceedings of The 17th International Congress on Sound and Vibration, Cairo, Egypt.
8. GOŁAŚ A., SUDER-DĘBSKA K., CIESIELKA W., FILIPEK R. (2011), *Verification of inverse image source method applied for acoustic field creation in open area*, Acta Physica Polonica A, **119**, 6-A, 966–971.
9. HIDAKA T., BERANEK L. L., MASUDA S., NISHIHARA N., OKANO T. (2000), *Acoustical design of the Tokyo Opera City (TOC) concert hall, Japan*, The Journal of the Acoustical Society of America, **107**, 1, 340–354.
10. HOJAN E. (2003), *Principles of amplify the room and open area*, [in Polish: *Zasady nagłaśniania pomieszczeń i przestrzeni otwartej*], Wydawnictwo Naukowe UAM.
11. ISHIZAWA M., MAFUNE Y., ENDO H., RIKO Y. (1998), *A manufacturer's review of the progress of large scale electro-acoustic systems in auditoria*, Acta Acustica united with Acustica, **84**, 311–319.
12. KUŁOWSKI A. (2007), *Room Acoustics*, [in Polish: *Akustyka sal*], Wydawnictwo Politechniki Gdańskiej.
13. KUTTRUFF H. (2009), *Room Acoustics*, Spon Press.
14. LONG M. (2006), *Architectural Acoustics*, Elsevier.
15. MARSHALL A. H., BARRON M. (2001), *Spatial responsiveness in concert halls and the origins of spatial impression*, Applied Acoustics, **62**, 91–108.
16. MECHEL F. P. (2008), *Formulas of Acoustics*, Springer-Verlag.
17. MEYER J. (2009), *Acoustics and the Performance of Music*, Springer Science+Business Media, LCC.
18. TOOLE F. E. (2008), *Sound Reproduction. Loudspeakers and rooms*, Focal Press.
19. UREDA M. S. (2001), *Line arrays: Theory and applications*, The 110th Convention of Audio Engineering Society.