



PREDICTION OF THE SLOPE MOVEMENTS ON THE BASE OF INCLINOMETRIC MEASUREMENTS AND NUMERICAL CALCULATIONS

Lesław ZABUSKI¹

Abstract. The slope movement has been examined in 4 boreholes located on it, on the base of systematic inclinometer measurements performed during two years. The movement was equal to few millimetres or even centimetres per year, depending on the borehole. Current deformation activity observed on the slope means that application of any static model for stability calculations would be incorrect. Thus, the mass was modelled as creeping material and calculations of the movement have been carried out using Burger’s creep model and finite difference method. The results of inclinometric measurements allowed both for choosing parameters of the model and for verification of calculation results. The measured deformations occurred in shallow range, up to 6 m. Calculations proved that although the soil is nearly homogeneous from a lithological point of view, it has different mechanical parameters with values increasing with depth. Only differentiation of the parameter values depending on the depth allow for confinement of the movement to shallow depth range. The final results show satisfactory agreement between measured and calculated results which developed in two years. The elaborated numerical model could serve as a tool for prediction of further slope deformations.

Key words: inclinometer measurements, creep, numerical simulation, forecasting, landslide.

Abstrakt. Na podstawie dwuletnich pomiarów inklinometrycznych w czterech otworach rozmieszczonych na zboczu przeprowadzono badania ruchu osuwiskowego zbocza. Prędkość przemieszczeń wynosiła od kilku milimetrów do kilku centymetrów rocznie. Aktualne deformacje zbocza wskazują, iż zastosowanie do analizy stateczności jakiegokolwiek modelu statycznego jest niewłaściwe. W związku z tym, masyw zbocza modelowano jako materiał wykazujący właściwości reologiczne (pełzanie) oraz wykonano obliczenia procesu deformacji metodą różnic skończonych, stosując model pełzania Burgersa. Wyniki pomiarów inklinometrycznych umożliwiły zarówno dobór wartości parametrów modelu, jak i weryfikację wyników. Mierzone deformacje występowały w strefie płytkiej, na głębokości do 6 metrów. Obliczenia dowiodły, że chociaż masyw jest jednorodny litologicznie, to wartość jego parametrów mechanicznych rośnie wraz z głębokością. Tylko wprowadzenie takiego zróżnicowania do modelu numerycznego pozwala na ograniczenie przemieszczeń do płytkiej strefy. Rezultaty końcowe wskazują na zgodność między wynikami dwuletnich pomiarów i obliczeń. Opracowany model może służyć do prognozowania przemieszczeń zbocza.

Słowa kluczowe: pomiary inklinometryczne, pełzanie, symulacja numeryczna, prognozowanie, osuwisko.

INTRODUCTION

Slope stability calculations are one of the most important tasks in geo-engineering. They are typically based on few assumptions. More advanced methods use elasto-plastic models of rock and soil medium. The results of such calculations usu-

ally show the final shape of the slope after failure, in which it reaches new equilibrium state, i.e. further deformation does not occur. However, active landslide slopes exhibit continuous deformations and equilibrium is usually not observed. Such mov-

¹ Polish Academy of Sciences, Institute of Hydro-Engineering1, Kościarska 7, 80-953 Gdańsk; e-mail lechu@ibwpan.gda.pl

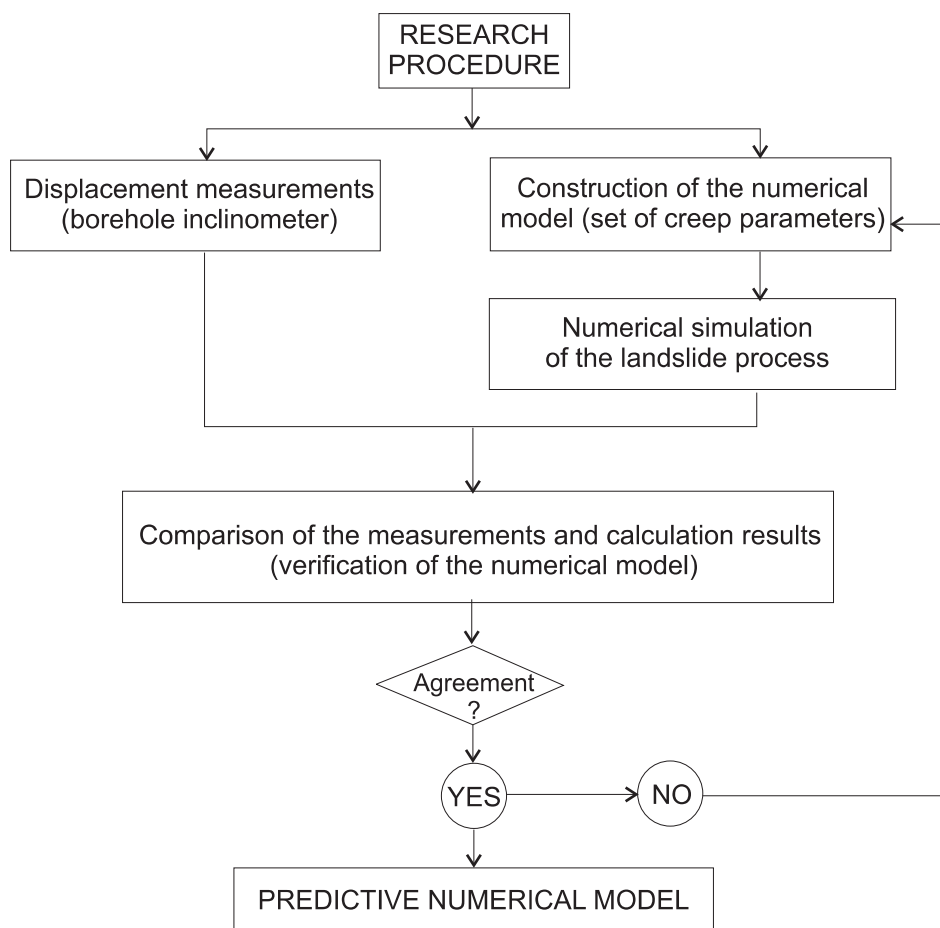

Fig. 1. Research procedure

ing slope “Kawiory” in Beskid Niski Mts. (Low Beskid) has been investigated in details (Zabuski *et al.*, 2004)². It is generally built of flysch, containing cohesive soils and weak clayey rock. The research comprised numerous investigations, in which different methods both geological and geotechnical were applied.

The slope movement has been examined in boreholes located on the slope, on the base of systematic inclinometer measurements. Then, the numerical analysis of the deformation process has been carried out. The measurement results allowed both for choosing parameters of the numerical model and for verification of calculation results. The medium was modelled

as creeping material and simulation of the movement has been carried out using Burger’s creep model and finite difference method. The validated numerical model could be used as prediction tool, allowing for calculation of future slope deformations, under the assumption that any unexpected phenomena do not occur.

The above mentioned studies are described in the paper. At first, research procedure is explained. Then the inclinometric and numerical results are analysed and comparison of the results from these two kinds of methods is presented. The predictive possibilities of the numerical model are finally considered.

RESEARCH PROCEDURE

The procedure is schematically shown in Figure 1. After the first results of the measurements are obtained, it is possible to establish preliminary geomechanical model of the moving

slope. The most important task here is to determine the values of the model parameters, as it allows for the beginning of the numerical simulation. When the first trial of the calcula-

² Research has been performed in frames of 5th EC Programme, Project “ALARM” (Assessment of Landslide Risk in Mountain Areas) and in frames of the Polish Committee for Scientific Research (KBN) project (Investigations of the representative landslide process in Carpathian Flysch — experimental landslide in Beskid Niski Mts.).

tions is performed, it is possible to make a comparison between measurement and calculation results. If they agree, the model is reckoned as accurate. Next results of the measurements could confirm (or not) its correctness. In the positive case,

the model can be used for prediction of the future behaviour of the slope. It is rather exception; usually, at least few or more trials have to be done to reach sufficiently good agreement.

INCLINOMETRIC MEASUREMENTS

In the first stage of investigations three boreholes (K1, K2, K3) were drilled. Two of them are located approximately along the line, which agrees with the direction of the slope movement (Fig. 2). Some time later, the fourth borehole (K4) was additionally carried out. The depth of the boreholes was chosen with taking into account probable depth of the currently active slip surface.

Boreholes were then equipped with specially designed casing. It made possible to insert the inclinometer probe (Fig. 3) and to execute the measurement of the borehole shape in direc-

tion which is known, as the probe moves along specially, oriented grooves (Fig. 4).

Individual readings determine the inclination of the probe to the vertical. The readings are taken every 50 or 100 cm, beginning from the bottom of the borehole up to its top. Displacement of any borehole section could be calculated by comparison between the results from j-th and from initial (so called "reference") series. Following formula is used for calculation of the displacement increment of i-th section:

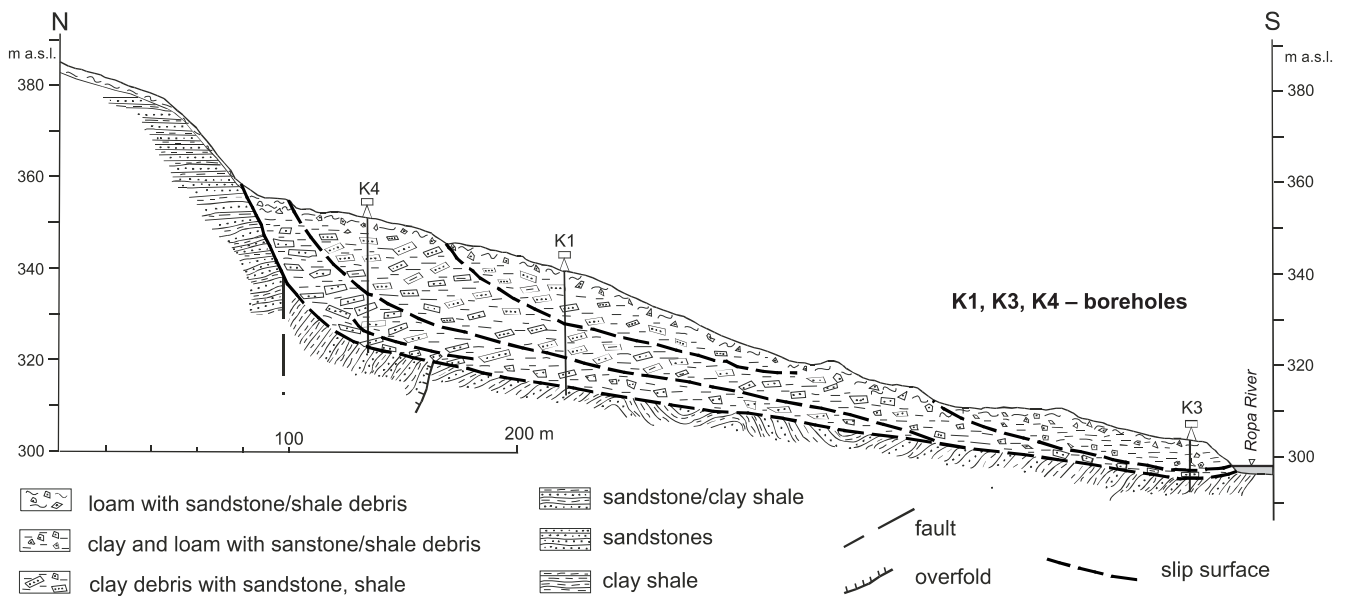

Fig. 2. Longitudinal section of the landslide (after A. Wójcik in: Zabuski *et al.*, 2004)



Fig. 3. Apparatus for inclinometer measurements (photograph from the User's Guide of the manufacturer "Geotechnical instruments")

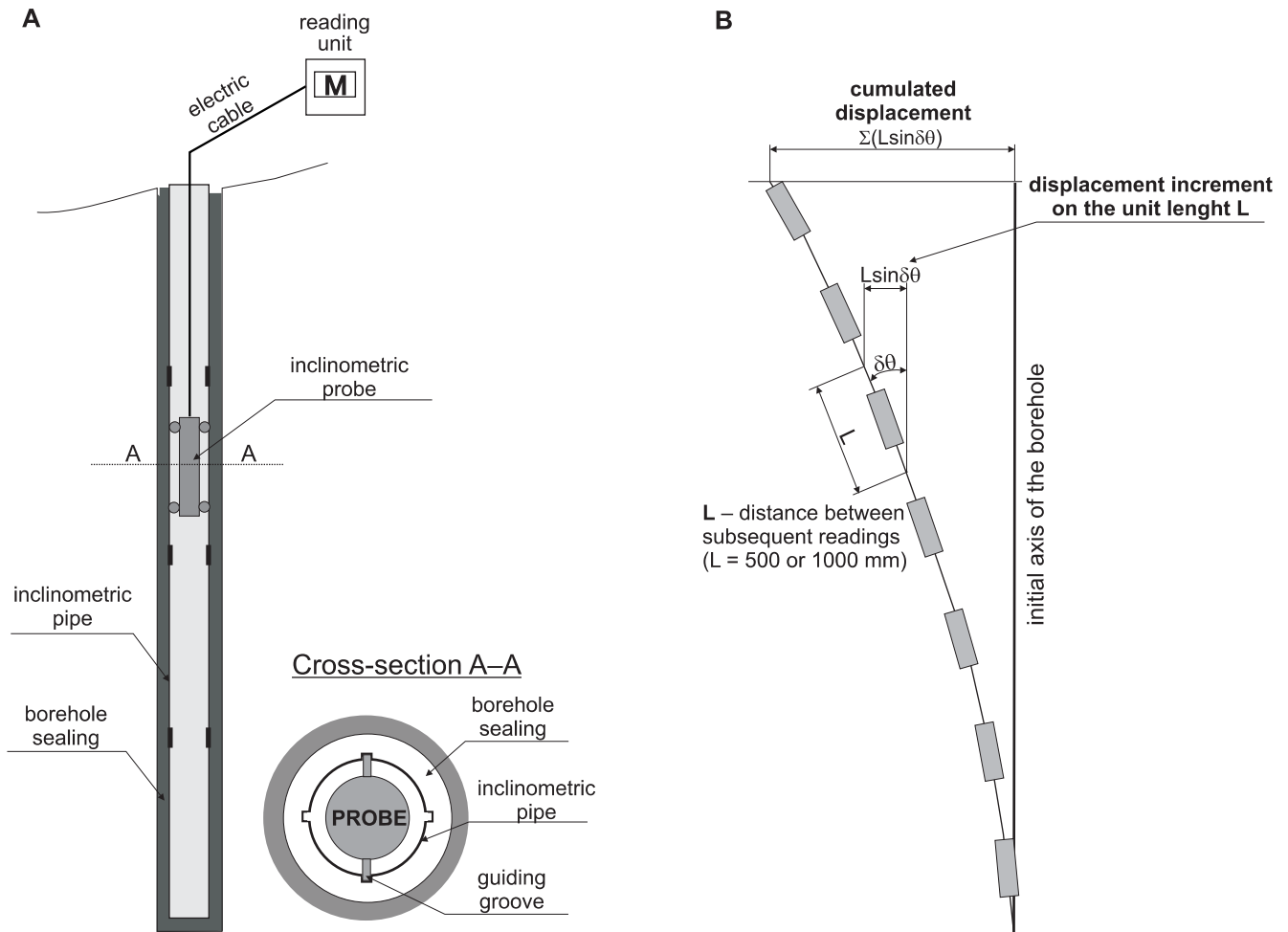

Fig. 4. Principles of inclinometric measurements

A — borehole with moving probe; B — calculations of borehole displacements

$$\Delta u_{ij} = L \times [\sin(\delta \theta_{ij}) - \sin(\delta \theta_{io})]$$

where:

$\delta \theta_{ij}$ — angle of the probe inclination in i -th section in j -th series,

$\delta \theta_{io}$ — angle of the probe inclination in i -th section in reference series.

Cumulated displacement of the borehole is a sum of all above increments — from its bottom to the top. The following formula is used:

$$\Sigma \Delta u_{ij} = \Sigma \{L \times [\sin(\delta \theta_{ij}) - \sin(\delta \theta_{io})]\}$$

The series of measurements were carried out with average frequency 1 series/month. It allowed for relative good estimation of displacement processes.

The exemplary curves are presented in [Figures 5 and 6](#), for borehole K1 and K3 respectively. On the left side of the figure, cumulated displacement curves are drawn, whereas the curves of increments of individual sections are shown on its right side. It could be seen that in some cases the curves of displacement increments allow for more precise determination of the slide surface depth than the cumulative ones.

Very shallow movement is observed in K1 borehole. Some signs of the movement are also visible at the depth of about 10.5 m, but they are problematic due to the small values of the displacement. More deep slide surface, located at the depth of about 6 m, could be clearly seen in K3 borehole. Less significant movement appears at the depth of 1.5–2.0 m. The results prove that only few metres deep zone is currently active, especially in the lowest part of the slope.

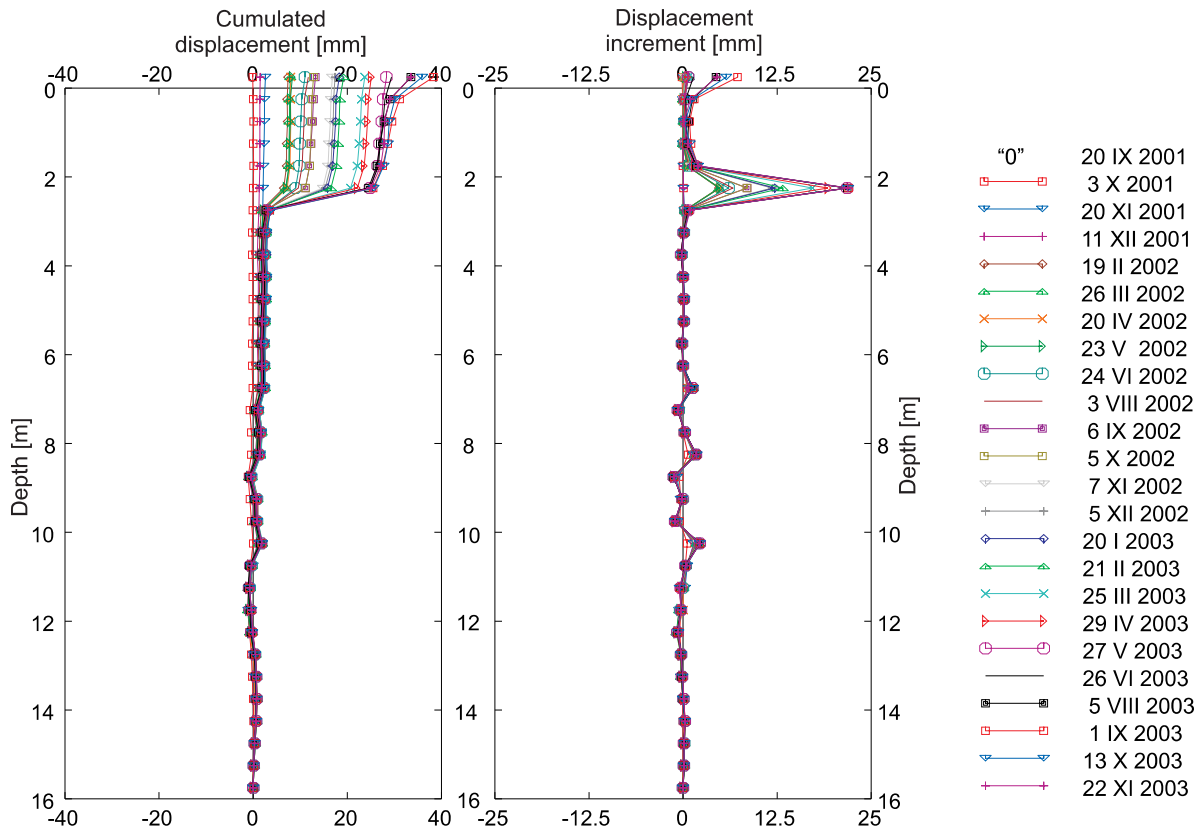

Fig. 5. Displacement curves of K1 borehole

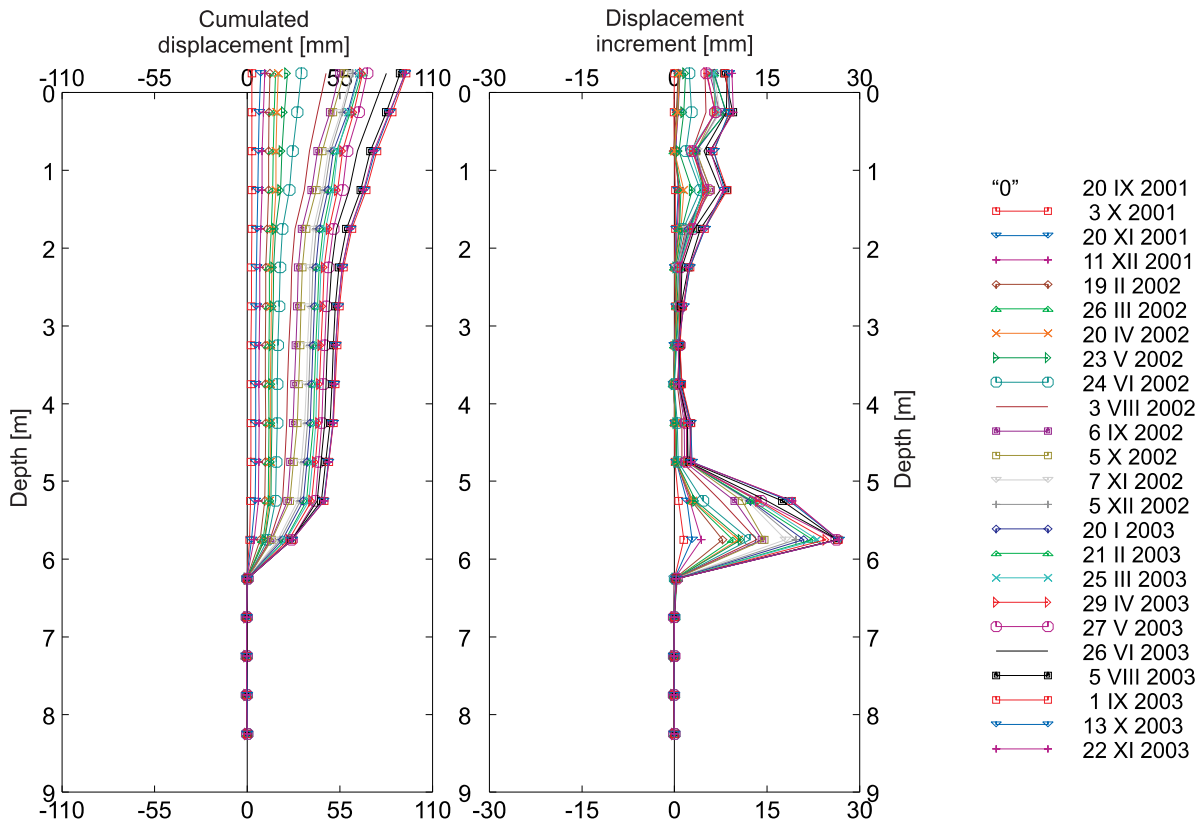

Fig. 6. Displacement curves of K3 borehole

NUMERICAL SIMULATION OF THE DEFORMATION PROCESS

GEOMECHANICAL MODEL

It could be generally noticed that the slope can not be considered as a stable, if it moves. Thus, the elasto-plastic model, usually employed in cases of stability analysis could not give appropriate results, as it can only simulate ideally stable state (without further displacement) or the state, in which the system

can not reach stability conditions, and displacements grow without any limits. It must to be pointed out that the elasto-plastic models do not take into account time variable.

The model which allows to generate the development of the deformations in real time should take into account rheological properties of the medium. The soil with clay particles exhibits creep behaviour, and relation deformation-time could be established. However, parameters of such model have to be pro-

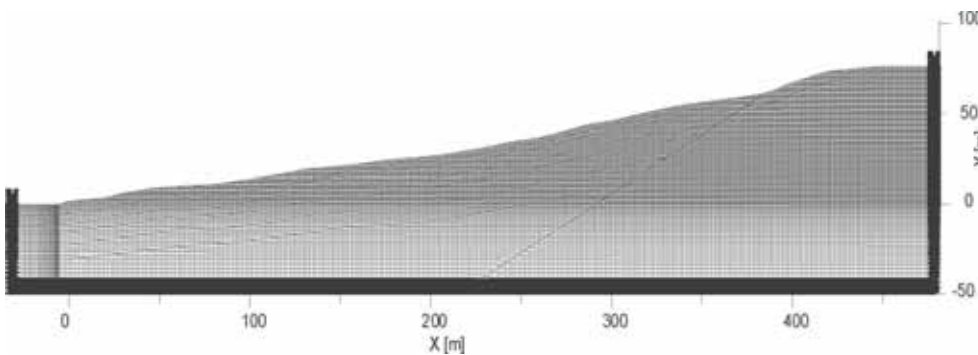

Fig. 7. Kawiry landslide — finite difference grid

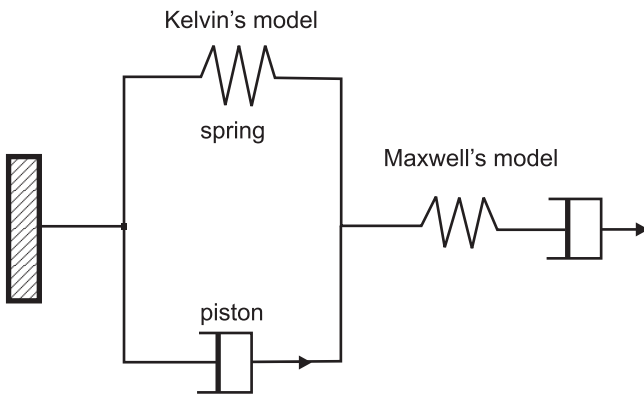

Fig. 8. Scheme of Burger's model

vided, describing especially viscosity properties.

Due to complexity of the tests, it was impossible to determine a priori any viscosity coefficients. Thus, the procedure used in the described analysis is based on the trial and error method. It means that some trial coefficients are taken, when the model is elaborated. Then the creep deformation process is simulated by means of numerical calculations and the results are compared with these obtained from the measurements (see Fig. 1). In case of disagreement, next trials with new coefficient values are carried out until assumed agreement is reached.

The slope cross-section shown in Figure 2 is chosen and calculations are performed in plane strain state, using computer code FLAC 4.0 (FLAC, 2000), based on the finite differ-

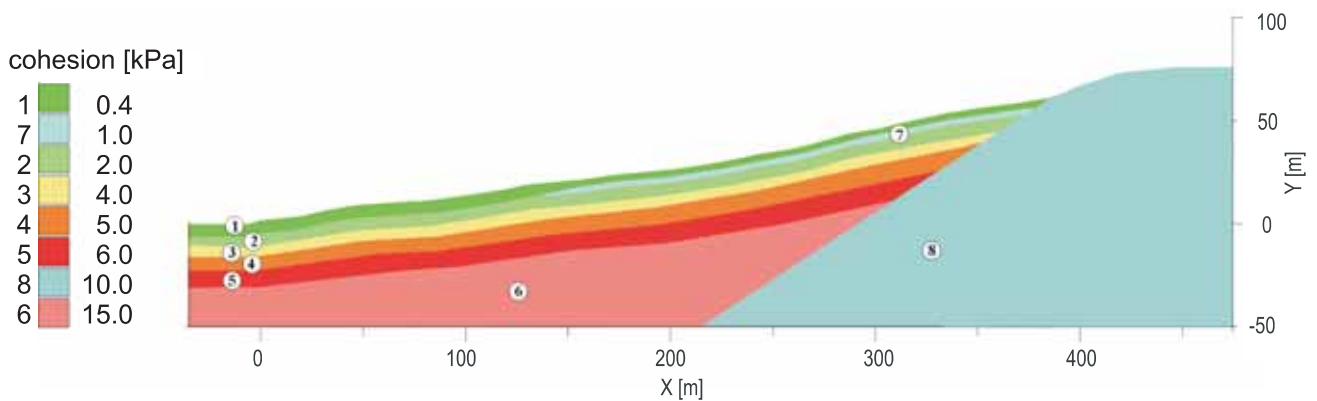

Fig. 9. Cohesion of geomechanical zones (layers) in the slope

Table 1

Geomechanical parameters of the model

Zone (layer)	Cohesion [kPa]	Friction angle [°]	Tension strength [kPa]	Maxwell shear modulus [kPa]	Kelvin shear modulus [kPa]	Maxwell viscosity coefficient [kPa s]	Kelvin viscosity coefficient [kPa s]
1	0.4	9	0.2	7.7	5.0	4E+7	4E+7
2	2.0	15	1.0	65.4	1E+3	1E+14	1E+12
3	4.0	20	2.0	65.4	1E+3	5E+14	5E+12
4	5.0	25	2.5	65.4	1E+4	1E+15	1E+13
5	6.0	30	3.0	65.4	5E+4	5E+15	5E+13
6	15.0	35	7.5	65.4	1E+6	1E+27	1E+27
7	1.0	10	0.5	65.4	1E+3	5E+13	5E+11
8	10.0	32	5.0	65.4	1E+6	1E+22	1E+22

Zones 6 and 8 — bedrock

ence method. The slope body is divided into finite difference zones (Fig. 7). Elasto-viscoplastic behaviour of the medium is assumed, according to the Burger's creep law, whereas modified Coulomb-Mohr criterion is taken into account for the description of the plastic behaviour (Zabuski, 2001). Burger's model is composed of Kelvin's and Maxwell's parts (Fig. 8). Both comprise the spring (elasticity) and the piston (viscosity) members. Burger's model is described by the relations between strain, strain rate, stress and stress rate (FLAC, 2000). There are four coefficients in the model equations, namely Kelvin and Maxwell viscosity coefficients (pistons) and shear moduli of elasticity (springs).

Geomechanical model of the slope is divided into zones, and the mechanical properties of the medium change with depth. Figure 9 shows an example of the distribution of the cohesion. All parameters are set in Table 1.

There are difficulties connected with the determination of the trial values of the viscosity coefficients. The data in the literature are not numerous. Sun and Zhou (Sun, Zhou, 1983) report the values for clay shale; the range of viscosity coefficients is equal to $2.9E+14 \div 1.2E+15$ kPa s. It is only one information which was found, regarding the material similar to the soil, which builds the slope under consideration.

RESULTS OF CREEP SIMULATION AND COMPARISON OF CALCULATION AND MEASUREMENT RESULTS

The results have twofold character. The process of the two-years creep is simulated and the results show the distribution of the displacements in the slope. Figure 10 presents the field of

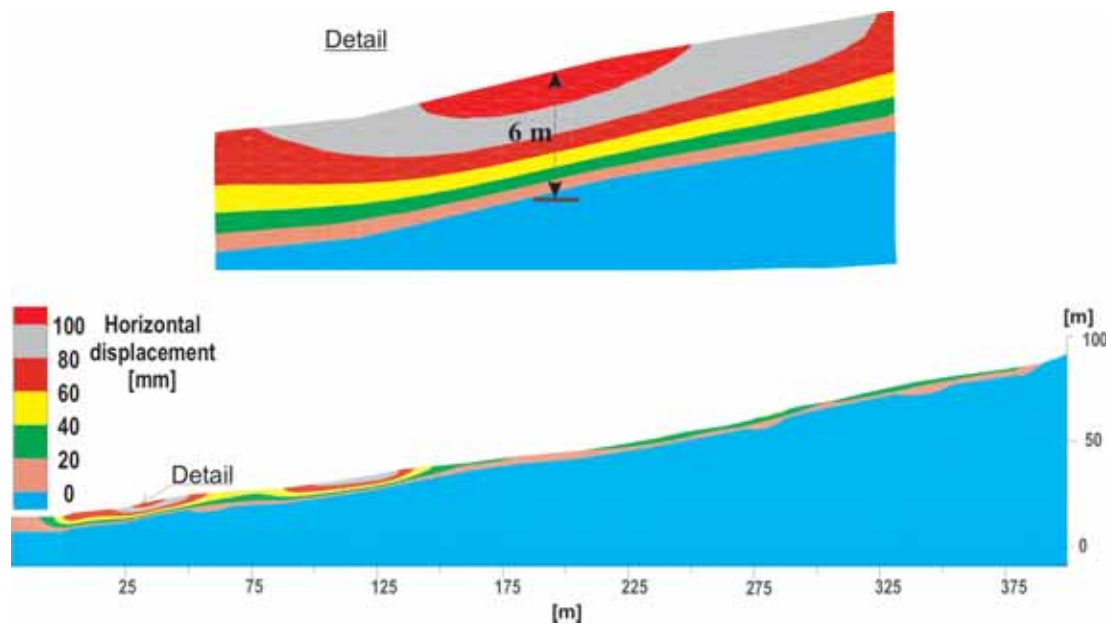

Fig. 10. Horizontal displacement of the slope, as an effect of two-years creep

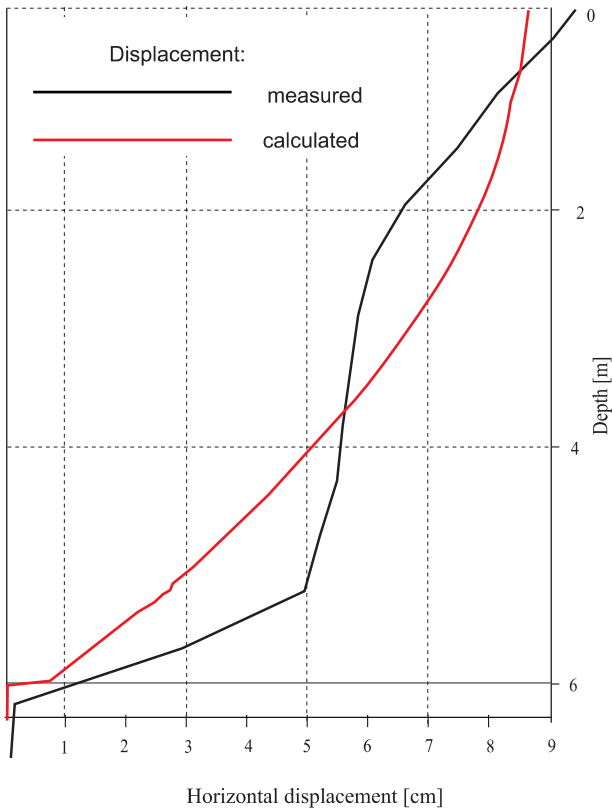

Fig. 11. Two-years horizontal displacement measured and calculated in K3 borehole

horizontal displacements. It is clearly seen that the displacement in the lower part of the slope dominates, and the range of its depth is greatest here.

Verification of the model suitability is made by comparison of the results obtained with those from measurements. Figure 11 shows the displacement curves. Despite of some differences the agreement is sufficiently good and the model can be accepted.

The model elaborated, with the parameters verified, could be used as a predictive tool, allowing for the determination of the slope behaviour in any assumed time. As an example, five-years displacement field and process is considered here. The distribution of horizontal displacement in the lower portion of the slope is shown on Figure 12, whereas Figure 13 presents the curves of the displacement of P1 and P2 points in function of time. It is clearly seen, that the curves are almost identical. Some very small curvature of the lines is visible; it means that the complete stabilisation of the system would probably take place after much more than 5 years.

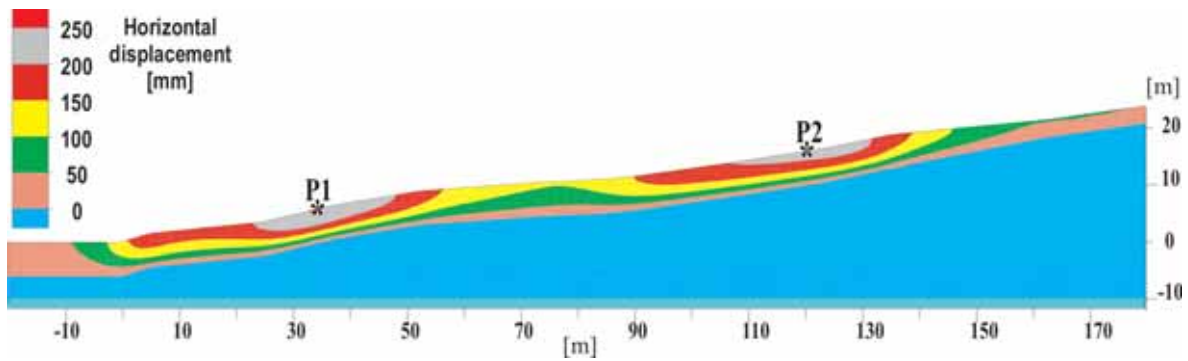

Fig. 12. Predicted five-years horizontal displacement of the slope

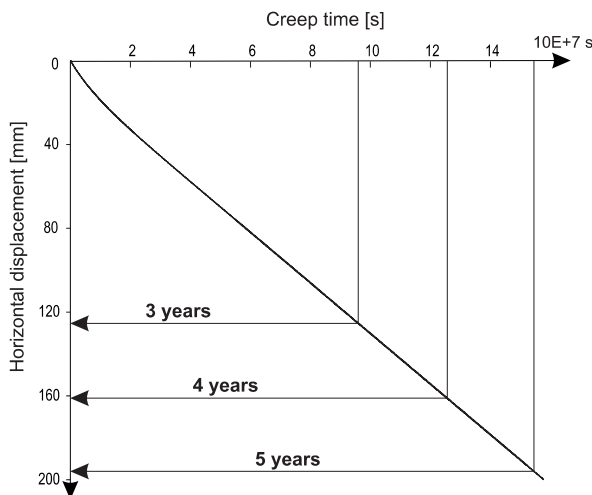

Fig. 13. Curves of horizontal displacement of P1 and P2 points versus creep time

SUMMARY AND CONCLUSIONS

The results presented in the paper prove that the modelling of the creep phenomena of the landslide slope is possible with the sufficient accuracy, even if the coefficients of viscosity are not known. However, it is necessary to verify the model in such cases. In fact, it is difficult to perform the creep tests and in the literature the data regarding the viscosity coefficients are reported very rare. Thus, the measurements have to be performed to obtain the information about the real deformation processes.

Basing on the final results of the trial and error procedure, it is possible to determine at least the range of creep coefficient values for shale flysch (see [Table 1](#)):

Maxwell coefficient = $5E+13 \div 5E+15$ kPa s

Kelvin coefficient = $5E+11 \div 5E+13$ kPa s

It should be mentioned that the values of the coefficients are dependent on the clay content in the mass. The higher it is, the lower the values.

The predictive power of the model is limited to the soil and rock masses having the geologic properties similar to the properties of the mass building analysed slope. It should be also pointed out that the slope structure has to be carefully modelled, as the mass is geomechanically heterogeneous and its quality changes (increases) mainly with depth. It creates additional difficulties and complicates the numerical model. In any case, it is always possible to find the proper model if some elements (e.g. displacements) are at disposal enabling the verification of the appropriateness of the calculation results.

REFERENCES

- FLAC 4.0 User's Manual, Itasca Consulting Group Inc. Minneapolis, 2000.
- SUN G., ZHOU R., 1983 — The structural effect in the mechanical behaviour of clay shale. Proc. 5th Int. Congress Rock Mech., Melbourne, 1, A153-A155
- ZABUSKI L., 2001 — Stress and deformation distribution in the tunnel lining and in the rock mass surrounding the tunnel) [in Polish]. IBW PAN Gdańsk (unpublished).
- ZABUSKI L., GIL E., RĄCZKOWSKI W., WÓJCIK A., 2004 — Investigations of the representative landslide process in Carpathian Flysch — experimental landslide slope in Beskid Niski Mts.) [in Polish]. IBW PAN Gdańsk, KBN Project, final raport (unpublished).