

EMISSION INVENTORY OF EXHAUST GASES FROM OIL-FIRED SHIP BOILERS

Jarosław Myśków, Tadeusz Borkowski

Maritime University of Szczecin
Wały Chrobrego Street 1/2, 70-500 Szczecin, Poland
tel.: +48 91 4809400, fax: +48 91 4809575
e-mail: j.myskow@am.szczecin.pl, t.borkowski@am.szczecin.pl

Abstract

Regulations concerning the limitation of harmful compounds emission contained in exhaust gases become more restrictive. This is observed within regulations regarding land-based installations and also rules applied to ships of global trade fleet. Other restrictions of vessels emissions, enclosed in rules set out in Annex IV of Marpol Convention 73/78 are gradually implemented and establish emission limits for ship engines. The boiler delivers the heat energy required for fuel preparation for main and auxiliary engines – and also by consuming fuel in its combustion chamber becomes and emitter. This article describes the anticipated methodology of the boiler steam efficiency, depending on the main engine installed. Additionally, fuel oil consumption analysis in various steam capacity range performed using the histograms. The histograms were produced on the basis of service reports of similar units, and combining fuel oil consumption with exhaust emission during operation. A vessel engine report includes monthly machinery abstract and is compiled for a ship-owner on the basis of the log book records. Quantified exhaust emission from auxiliary oil fired boiler contributes determination the overall emissions from a ship.

Keywords: *Ship, oil-fired boiler, marine diesel engine, exhausts emission*

1. Introduction

Legal regulations regarding limiting the emission of harmful compounds contained in exhaust gases become more restrictive. The restrictions of vessels emissions, enclosed in rules set out in Annex IV of Marpol Convention 73/78 are gradually implemented and establish emission limits for ship engines. They are known as Tier I (obligatory since 2000), Tier II (in use since 2011) and Tier III (applicable from 2016). These rules define in a detailed way the emission values for main and auxiliary internal combustion engines installed on ships. Tier III concerns special areas which include: the Baltic Sea, the North Sea and the coast of the United States of America. The aforementioned regulations aim at restraining of emissions of harmful substances contained in exhaust gases, especially in these zones where pollution deposition is on inhabited areas. Engine manufacturers, ship owners and scientists seek various possibilities of enabling meeting the requirements outlined in regulations. In order to prepare a full inventory of ship emissions, all emitters found on the ship should be taken into account. Thus apart from internal combustion engines considered in the regulations as sources of emissions, there are also auxiliary oil-fired boilers.

2. Ship steam systems overview

The main task of an auxiliary steam boiler is to provide service properties of heating fluid generated by a system designed for it, either steam-, thermal oil- or water-based. The property of the auxiliary steam boiler operation results from the need for heat energy which is indispensable to keep certain parameters of operational engine room systems that includes: fuel oil and lubricating

oil temperature in storage and service tanks, piping, filters, valves; cooling water temperature of the main propulsion and auxiliary engines during the start-up period.

The need for heat energy is dependent on:

- ambient - external air and water temperature, formed by climatic region and ship's operation area,
- amount of fuel oil in storage tanks and required viscosity in systems,
- vessel type and operation mode.

The major components of the steam system are:

- steam boilers (oil-fired boiler and exhaust gas boiler),
- steam consumers,
- feed water tank and pumps,
- valves/controllers.

Usually, the composite boiler contains an exhaust gas section for seagoing operation and oil fired section for port operations. Both means of boilers may be used simultaneously or individually. The auxiliary boiler capacity is approximately 1.5-3.0 t/h at 7.0 bar of working pressure. The oil-fired section is maintained by single fully automatic oil burner. The fuel oil is supplied from the DO/HFO (Diesel Oil or Heavy Fuel Oil) service tank. A PID pressure controller modulating the fuel flow and the air flow to the burner effectively maintains the steam pressure. Finally, the burner can be automatically started and stopped. To control the steam pressure when the oil-fired section is off, a separate steam pressure controller is in operation. Then, it sets the exhaust damper position, accordingly. When the steam flow rate is low, more exhaust gas is by-passed and vice versa.

Water to the boiler is supplied from a feed water tank by means of two feed water pumps, which one is normally running. Accurate water level in boiler's drum is controlled through the feed water valve and PID level controller. Steam boiler is equipped with safety system that consists of high-high water level arrangement to protect against the "water strike". The boiler's safety system also includes a safety valve to avoid high steam pressure. Additionally, vent valve for use during start up heating and water drain valve is built in. The outlet condensated steam, flowing from steam consumers is collected in feed water tank. The example of the typical steam system is presented on Fig. 1.

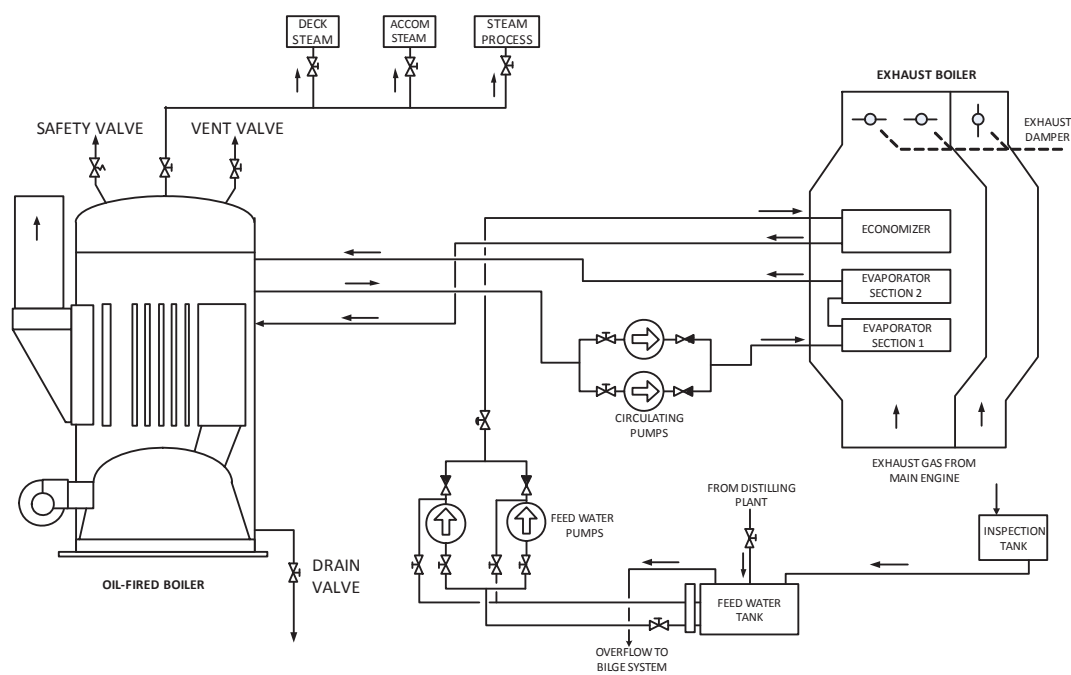

Fig. 1. The example of the steam system

The exhaust gas boiler consists of two ducts through which the exhaust gases from the main engine pass. One of the ducts contains the banks of heat exchanger, and the other one is plain to bypass the heat exchangers. The dampers position are regulating by the PID controller. The role of the top bank of tubes is the economizer section. The next two banks are the evaporation section. The water from the oil fired boiler water drum is pumped by the circulation pump and enters to the evaporation sections. The steam/water emulsion leaves exhaust boiler via the upper section and returns to the steam drum of the oil fired boiler.

3. Steam plant operation mode

With reference to cargo vessels, in the time structure of operating conditions, two of them can be distinguished: usability and non-usability. Non-usability of a vessel means its damage and a periodical exclusion due to repairs whereas usability means berthing (during load-unload cargo periods), anchor (waiting for the call, for the pilot or making room at the quay), manoeuvres (call-departure) and steaming (cruising for or with a cargo – a ballast condition). Basic ships operational layout shows Fig. 2.

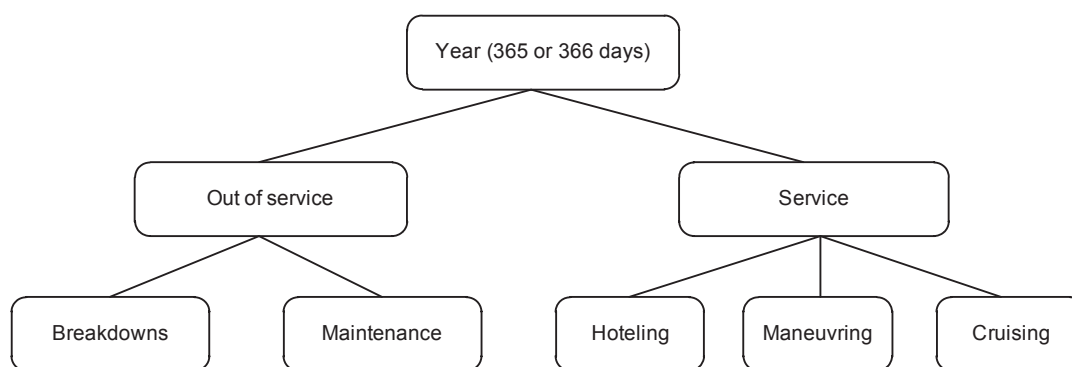

Fig. 2. Ships' operation time layout

With regard to immense differences in the distance covered by vessels between ports and to the recurrence of the climatic conditions, a longer period of observation, usually a calendar year becomes a more comfortable reporting period than a single cruise. Therefore, it is one year which became the basis for the time structure analysis of ships' operating conditions. The load characteristics of the auxiliary steam boiler operation might be presented in the form of a service capacity histogram. The diagram is based on collected ships' service data which contains: engine reports and log-book abstracts. The operation analysis of auxiliary steam boiler required:

- forming a sample set number,
- selecting similar ships and collecting source documents, mostly engine reports in order to draw steam capacity histogram.

A vessel engine report includes monthly machinery abstract and is compiled for a ship-owner on the basis of the log book records. The log book contains the information on the operational engine room factors, service life, fuel consumption of given devices as well as on the storage fuel oil consumption and the storage lubricating oil in tanks. The most frequently used time interval with reference to the exhaust emission sources is the calendar year for standards and legal regulations on the exhaust gas emission into the atmosphere set the allowed emission by means of it [1, 2, 4].

Below, as an example – Fig. 3, a method for establishing the load histogram of the auxiliary steam boiler is presented for a container carrier, with deadweight of 11 998 BRT equipped with a large bore, slow speed and two stroke engine with nominal brake power of 7950 kW. The water-steam heating system with the boiler nominal capacity of 1.6 t/h is installed on the vessel. The boiler is equipped with a rotary burner with the maximum fuel oil consumption of 130 kg/h.

To unify and compare different heating systems independently of the type of the boiler, kind of the burner, power supply system and heating fluid, the following absolute values were assumed:

- boiler nominal capacity $D_{nom} = 100\% = 1$,
- boiler relative load D/D_{nom} ,
- nominal fuel oil consumption $B_{nom} = 100\% = 1$,
- relative fuel oil consumption B/B_{nom} .

The observation lasted one year of the vessel operation and was divided into two six-month periods. Considering the recorded ambient temperatures, the first period of observation referred to the external conditions corresponding to operation in the tropics, the second period to ISO standards.

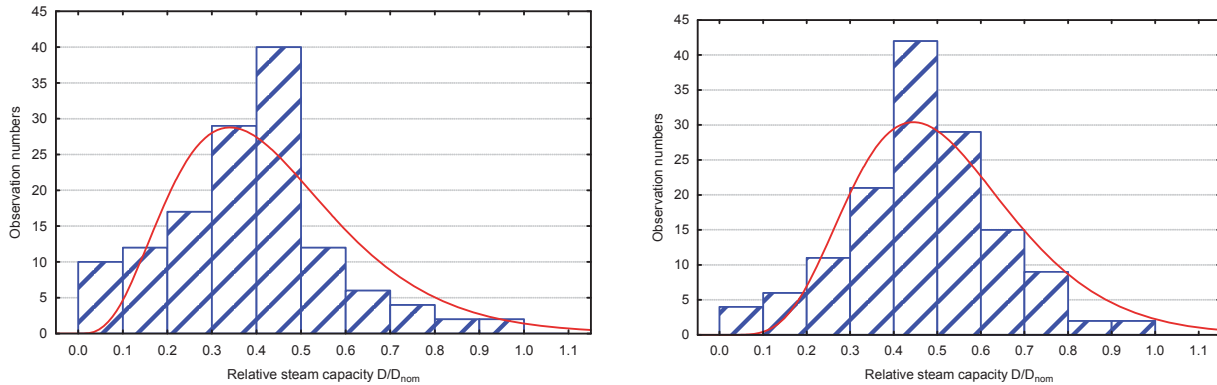

Fig. 3. The histograms of boiler load during the observation period (climatic zone – tropics-left, ISO standard-right)

The histogram (Fig. 3 - left) analysis shows most frequent boiler load that appeared within 0.4-0.5 of the boiler nominal load. During the six-month observation period amounting to 182 days, the auxiliary steam boiler operated for 132 days, where 125 days were in the port, during anchor – a roadstead and manoeuvres, while 7 days at sea with the main engine load reduction – an exhaust boiler assist. It results from the specific vessel operation (a container carrier – frequent mooring, manoeuvres, anchor – roadstead), vessel size (number of carried containers) and operating zone (mooring – load – unload). The histogram (Fig. 3 - right) analysis enables to assume that the most frequent boiler load for ISO standards was the same as for tropics and appeared within 0.4-0.5 of the boiler nominal load.

Table 1 presents the numbers and frequency of boiler load for container carriers, necessary to draw universal load histogram for this type of vessels in the series.

Tab.1 Summary of numbers for boiler load.

No.	Relative Steam Capacity	Hotelling, anchoring, manoeuvring		Cruising		All observation time	
		Observation numbers	Frequency	Observation numbers	Frequency	Observation numbers	Frequency
1.	0.0-0.1	25	0.057	0	0	25	0.052
2.	0.1-0.2	28	0.064	5	0.114	33	0.069
3.	0.2-0.3	34	0.078	15	0.341	49	0.102
4.	0.3-0.4	59	0.135	21	0.477	80	0.166
5.	0.4-0.5	129	0.295	3	0.068	132	0.274
6.	0.5-0.6	84	0.192	0	0	84	0.175
7.	0.6-0.7	41	0.094	0	0	41	0.085
8.	0.7-0.8	21	0.048	0	0	21	0.043
9.	0.8-0.9	9	0.021	0	0	9	0.019
10.	0.9-1.0	7	0.016	0	0	7	0.015
Total	-	437	1.000	44	1.000	481	1.000

Based on the table data, load histogram was drawn and presented in Fig. 4 for container carriers.

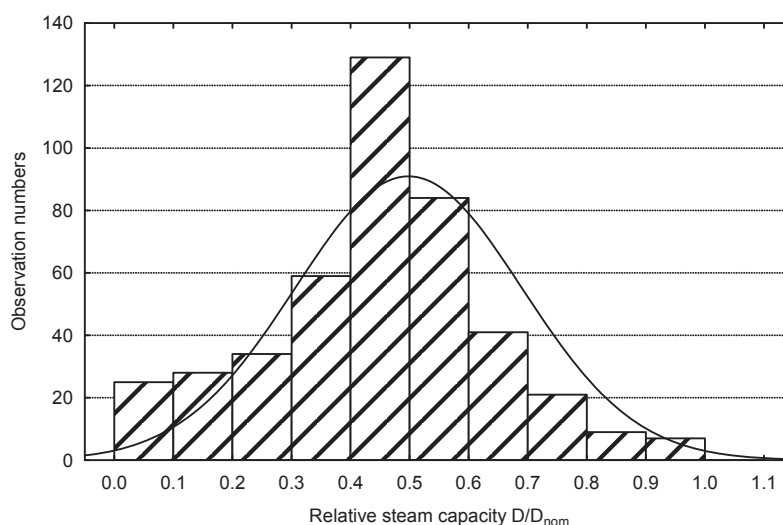

Fig. 4. An aggregated histogram of boiler load for container carriers

Drawing on engine report, the average boiler operation time was calculated for 24 hours – burner operation (only emission of exhaust gases is noticed). The boiler operates in parallel with the engine room holding the steam pressure in the steam system. The average burner operation time amounts to 15 hours per 24 hours. On the basis of the analyzed load distributions established on the basis of histograms might be assumed that:

- there are similarities as for the character of load for auxiliary steam boilers on the analyzed vessels,
- three characteristic points of operation could be identified:
 - 0.25 D/D_{nom} – minimum steam boiler load assuring a stable operation of the whole saturated steam system,
 - 0.50 D/D_{nom} – the most frequent boiler load,
 - 0.75 D/D_{nom} – boiler load with a higher demand for heating fluid (heating more fuel tanks e.g. after fuel oil bunkering).

Characteristic points of the load distribution for auxiliary steam boilers may be used to estimate the values of the weight coefficients - W_f , vital to conduct a test of auxiliary like it is done for main and auxiliary engines.

4. Stem boiler service performance

The aim standing behind the research on steam boilers was to calculate the substances in exhaust gases leaving the boiler combustion chamber in different load distributions. The vessel engine report data were used to calculate the rates required to establish the participation of a given load during the whole observation period. The load was established for the nominal boiler load on the basis of the fuel oil consumption. The form of the relative fuel oil consumption presented in figure and depending on the boiler relative load is characterized by a linear dependence, following the data of boiler manufacturers and is shown in the Fig. 5.

The formula may be present by the linear equation:

$$B/B_{nom} = 0.0244 + 1.0412 \cdot D/D_{nom}$$

According to the above formula the actual boiler load (or actual fuel consumption) may be easily calculated and used to total emission calculation from the ship. The next section describes results of the emission measurements.

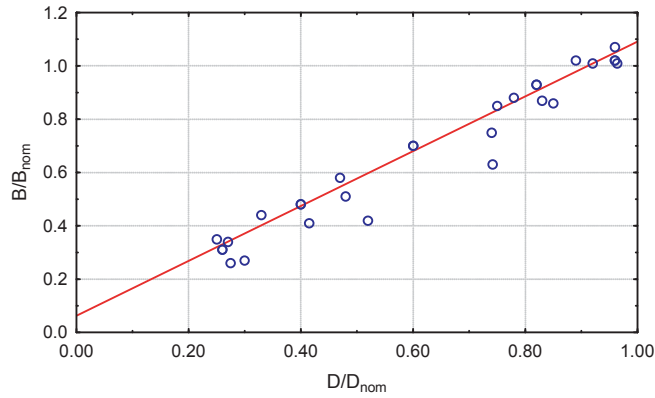

Fig. 5. Relative fuel consumption dependence on relative steam capacity

5. Results and discussion

The research on the auxiliary steam boiler was conducted in order to calculate steam capacity and estimate exhaust gas emission for a given boiler load. The research was performed at sea trials. The exhaust gas emission was calculated by means of portable, computer exhaust-gas analyzer. Considering the operation character – boiler load, the exhaust gas composition was calculated in parallel with analyzing boiler steam capacity. In this manner the amount of gases emitted into the atmosphere by the boiler with different load was estimated.

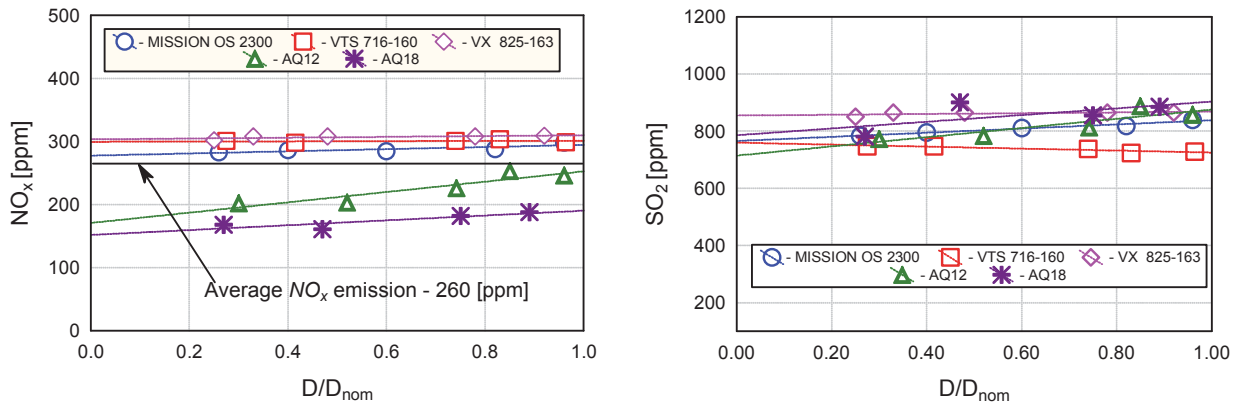

Fig. 7. Exhaust gas emission - NO_x and SO_2 during the sea trials

NO_x represents the sum of nitrogen dioxide - NO_2 and nitrogen monoxide - NO . NO_x emission increases with temperature and oxygen content in furnace. Unevenly distributed air/fuel creates high local temperature zones in combustion zone and gives higher, overall NO_x concentration [3, 5]. The average NO_x emission, presented in Fig. 7 (left), for relative boiler capacity was observed as constant value of 260 ppm, approximately.

The Fig. 7 (right) presents SO_2 concentration which depends on the sulphur content in fuel oil. The slight increase in SO_2 concentration at high excess air is due to the fact that more SO_2 is formed at high oxygen concentrations [3, 5]. The most efficient practical way of reducing sulphur emission in maritime applications seems to be removing sulphur from fuel oil in refinery by chemical processing.

The content of carbon monoxide CO in flue gas increases while excess air decreasing that shows Fig. 8 (left). When air-fuel ratio approaches stoichiometric value, CO emission increases intensely. Oil-fired ship's boilers allow operation at a lower air-fuel ratio without excessive CO , HC and smoke, giving high boiler efficiency and reduced NO_x values [3, 5]. Fig. 8 (right) shows typical CO_2 concentration trend, related to boiler's steam capacity.

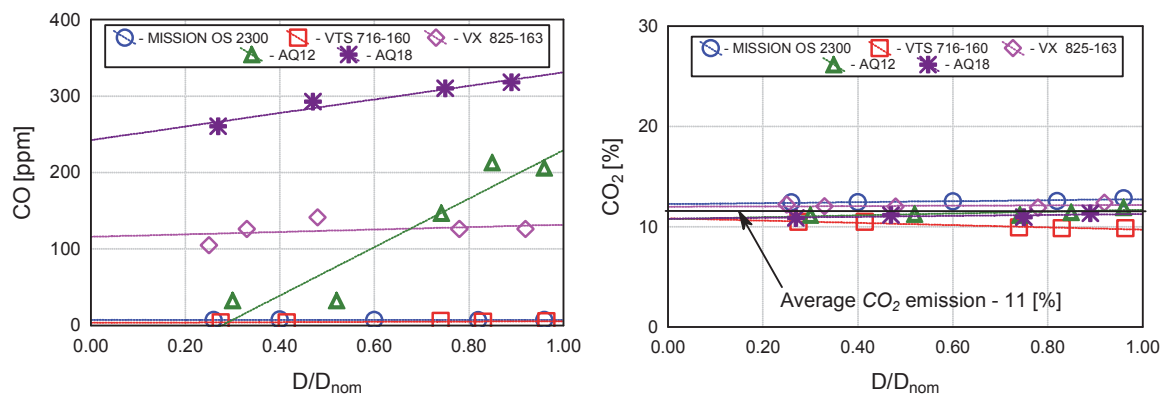

Fig. 8. Exhaust gas emission - CO and CO₂, during the sea trials

6. Conclusions

The complete ships' emission inventory should include oil fired boilers emission. The standard heating or steam boiler mostly operates during anchoring, hoteling and manoeuvring, when partial load of main engine occurs and steam flow rate is not sufficient. With main engine load increase, auxiliary exhaust boiler is taking growing part. Usually, when main engine load approaches of approximately 50% of nominal range, oil-fired boiler is switched off which is presented in Fig. 9, accordingly.

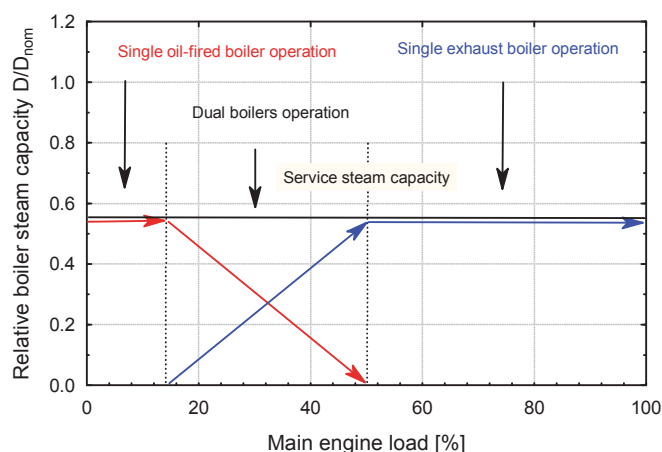

Fig. 9. Dependence between oil fired boiler load and main engine load

On the basis of the elaborated method, the emission into the atmosphere of toxic substances contained in exhaust gases is likely to be estimated. The attained results show emission of NO_x , CO and SO_2 emitted into the atmosphere. The combined approach with main and auxiliary engines emission utilized in presented method might determine the total emission from vessel. In summary, the comprehensive data might be included in total exhaust emission in shore side and port vicinity.

References

- [1] Dyrektywa Unii Europejskiej 96/61/EC - 1996, WHO 1987 European series No. 23.
- [2] Balcerski, A., *Studium projektowania układów energetycznych trawlerów łowczo-przetwórczych*, Zeszyty Naukowe Politechniki Gdańskiej – Budownictwo Okrętowe, Nr 58, Gdańsk 1991.
- [3] *Boiler Emission Reference Guide* – Cleaver Books Milwaukee, USA 1994.

- [4] Myśków, J., *A method of predicting the emission of toxic compounds from the exhaust gases of oil-fired auxiliary ship's boilers*, Obsługiwanie Maszyn I Urządzeń Okrętowych OMiUO, Maritime University of Szczecin, pp. 393-402, 2005.
- [5] Oland, C. B., *Guide to low emission boiler and combustion equipment selection*, Oak Ridge National Laboratory – Department of Energy, USA 2002.