

# MODERNIZATION OF THE KNI 140070 VIADUCT AND ITS INFLUENCE ON DYNAMIC RESPONSE UNDER SELECTED HIGH SPEED TRAIN

Piotr Szurgott, Damian Kozera

Military University of Technology  
Department of Mechanics and Applied Computer Science  
Gen. Sylwestra Kaliskiego Street 2, 00-908 Warsaw, Poland  
tel.: +48 22 6839941, fax: +48 22 6839355  
e-mail: pszurgott@wat.edu.pl

## Abstract

The paper develops a methodology of FE modelling and simulation of the bridge – track – moving train (BTT) system using LS-DYNA computer code. The KNI 140070 viaduct of span length 14.40 m with ballasted track was selected as a representative for the study. Two variants of the viaduct were taken into consideration – a version operated before the modernization in 2008 and the modernized version including additional flats welded to the bottom flanges of the main beams. The German high-speed train ICE-3 moving at 150–300 km/h was selected. The FE model of the BTT system was developed using Altair HyperMesh and LS-PrePost software. The platform of the viaduct was modelled using 8-node 48 DOF solid elements. The structure was symmetrised, homogenized and reflected by linear viscoelastic orthotropic materials. Discrete model of the track included the main and side rails, fastening systems, sleepers, crushed stone ballast and approach RC slabs. Components of the train FE model were considered as rigid bodies. Cylindrical and revolute constrained joints were applied for kinematic connections and relations between respective components. Discrete springs and dampers were applied for FE modelling of the primary and the secondary suspension systems. Numerical simulations were focused on determining the resonant velocities for both considered variants. Selected time histories for displacements and stresses, were shown as the results of the analyses.

**Keywords:** bridge – train interaction, composite bridge, ballasted track, ICE train, modelling and simulation

## 1. Introduction

Serious problems with durability protection of bridge superstructures, tracks and approach zones subjected to high-speed trains are observed presently. It is caused by complexity of bridge – track – moving train (BTT) systems, for which nonlinear models are described with a huge number of parameters. Many of these parameters, regarding fastening systems, ballast, subsoil layers, suspensions of the railway vehicles, etc., are difficult for identification. Therefore, some of them are mostly estimated. Producers and research institutions involved in modern high-speed trains do not bring to light structural details, values of parameters or their research results. Above-mentioned inconveniences make precise prediction of dynamic response of bridges under moving trains very difficult.

At present, it can be observe various numerical approaches to dynamics of bridges generally. Commercial CAE systems are more and more often used in such problems [1–6]. Modelled systems are generally three-dimensional, however they may be considered as simplified ones due to the vertical longitudinal plane of symmetry. Such approach was proposed by Authors in [7–11].

A methodology of FE modelling and simulation of the BTT system proposed in this study was developed with the use of commercial CAE systems. It is related to the composite (steel – concrete) bridge, ballasted track and high-speed train. Altair HyperMesh, LS-DYNA and LS-PrePost software was applied in the methodology. Author's approach is based on homogenization of the viaduct RC platform slab, RAIL\_TRACK and RAIL\_TRAIN modules for simulating the train – track interaction, non-linear modelling of rail fasteners and ballast, application of constrained joints and discrete springs and dampers for modelling suspensions in railway vehicles. The KNI 140070 composite viaduct and the ICE-3 high-speed train were selected as a representative for the study.

## 2. Description of considered objects

The composite (steel-concrete) viaduct KNI 140070, located at the Polish Central Main Line (PCM) No. 4–E 65, was selected for FE modelling and simulation. After recent modernization [11], the viaduct has the  $k = +2$  rail-line classification coefficient. Track spacing equals 4.57 m, the spans are of 14.40 m theoretical length and 15.34 m total length. Four main beams are 0.77 m high and made of St3M steel. Bottom flanges have been additionally reinforced with flats welded to them. The thickness of a new RC platform ranges from 0.29 m in the track axis to 0.25 m at the sidewall. The platform is made of C35 concrete reinforced with AII/18G2-b steel rears. The sidewall is made of C30 concrete and has vertical dilatations at 1/4, 1/2 and 3/4 of the span length. The RESTON pot bearings (on the left support) can shift up to  $\pm 50$  mm in the longitudinal direction. Bearings under the left inside main beam are unmovable in the lateral direction; the remaining bearings can displace in the lateral direction up to  $\pm 20$  mm.

The ballasted track consists of UIC 60 rails, PS-94/SB/UIC-60 sleepers with SB3 fasteners, and the first class ballast. The ballast layer under sleepers is 0.35 m thick. The embankment in the approach zones contains cement-stabilized subsoil while outside the approach zones a 0.2 m thick sand-gravel mix top layer has been applied. The tracks over the viaduct are quasi-rectilinear.

In order to adapt the track to high service velocities up to 300 km/h, theoretical modernization of the track has been designed. The UIC 60 main rails are fixed to B 320 U60 and B 320 U60–U sleepers with Vossloh 300-1 fasteners. The UIC 60 side rails, coinciding the length of the approach slabs, are fixed with SB3 fasteners. The RC (C30 concrete, 18G2 rebars) approach slabs have dimensions  $l \times b \times h = 10.2 \times 4.8 \times 0.2$  m. The embankment in the approach zones contains cement-stabilized subsoil.

Summing up, details of two considered variants of the viaduct – track sub-systems — before the modernization and after it, including mentioned theoretical modernization — are provided in Tab. 1. Schemes of the longitudinal and cross-sections of the sub-system are depicted in Fig. 1.

Tab. 1. Comparison of two considered variants of the viaduct and the track – only main differences are provided

Specification		Variant #1	Variant #2
Viaduct	Bottom flanges of the main beams	not reinforced	reinforced <sup>1)</sup>
Track	Side rails	no	yes <sup>2)</sup>
	Approach slabs	no	yes <sup>2)</sup>

<sup>1)</sup> modernization of the actual object  
<sup>2)</sup> theoretical modernization in order to adapt the track to high service velocities

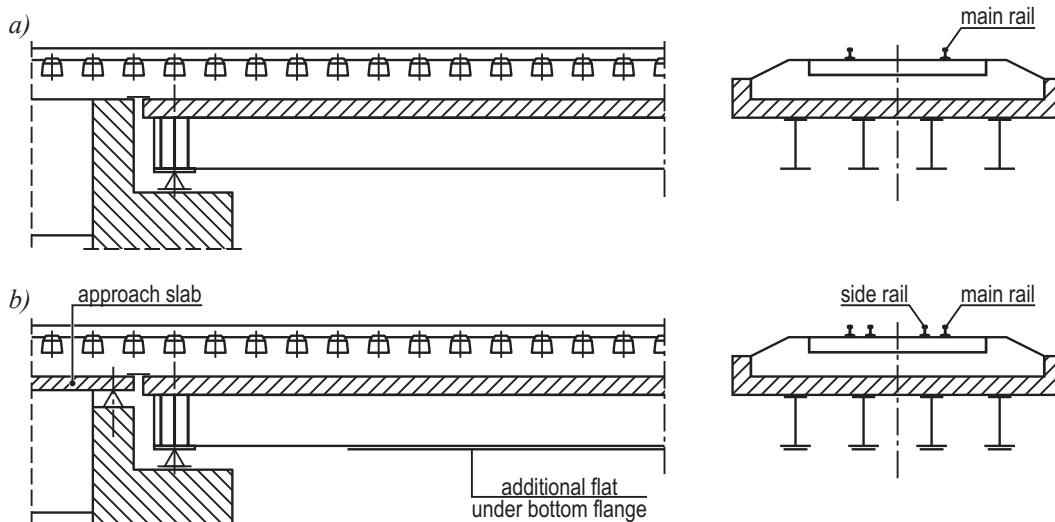

Fig. 1. The ballasted track in the viaduct zone: variant 1 – before modification (a), and variant 2 – modernized

The ICE-3 high-speed train considered in the study was presented in Fig. 2. The train was built by Siemens Company in 2000 and 2001 in the total number of 50 trains (Series 1). The ICE-3 is the third generation of German high-speed trains. The main difference in comparison to the previous generations is a multiple unit power system. The train has no end power heads as the ICE-1 train, but it has motor bogies located every second car. It results in improved operating parameters. The total weight is distributed evenly across the entire trainset, therefore the axle load is reduced to 16 metric tons.

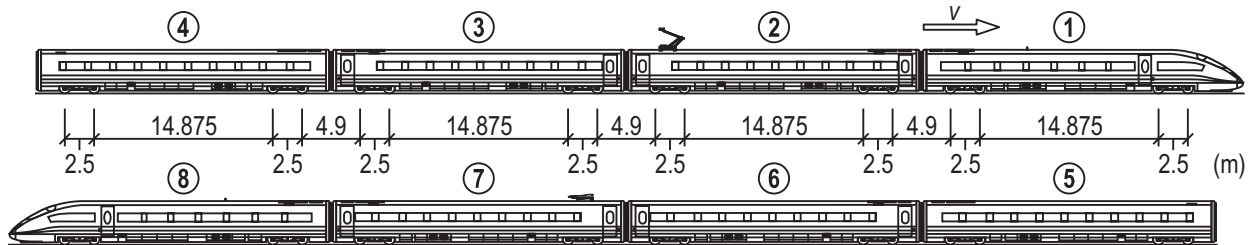

Fig. 2. Scheme of the ICE-3 trainset in considered configuration

### 3. Modelling of the BTT system

Proposed methodology of the viaduct modelling was described in detail in Author's previous papers [7–10]. The slab and the sidewall of the platform were homogenized since the reinforcement of the RC platform was distributed quasi-uniformly in the specified platform sections. After homogenization [12] the slab and the wall were reflected by linear viscoelastic orthotropic materials described by 3 Young's moduli, 3 Poisson's ratios, and 3 shear moduli in each subarea. Full symmetry of the viaduct platform was assumed. All bearings on the abutments are assumed unmovable in the lateral direction.

The FE model of the viaduct superstructure was developed in Altair HyperMesh software (Fig. 3). The numerical model of the bridge superstructure consists of 3896 4-node shell elements (steel main beams) and 5568 8-node 48 DOF solid elements (the homogenized RC platform was divided into orthotropic parts/zones). Bearings on the viaduct abutments were reflected by respective constraints.

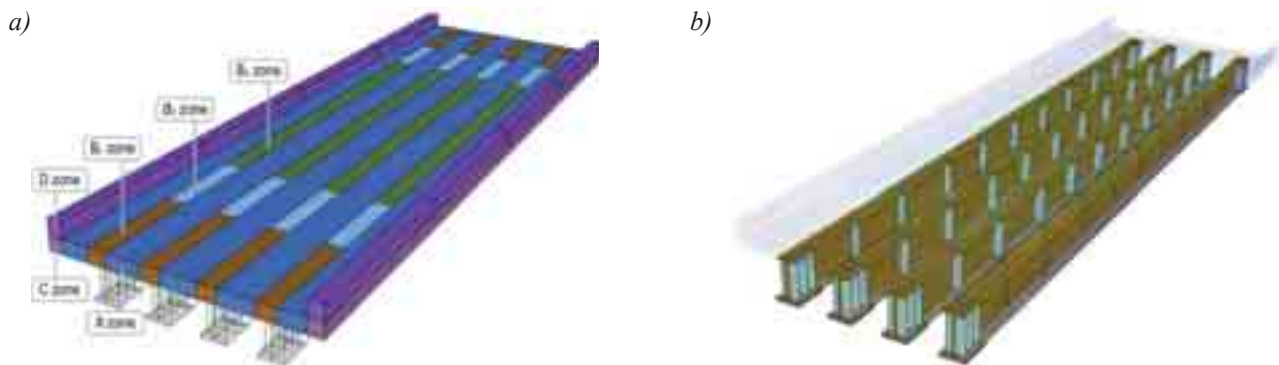

Fig. 3. FE model of the viaduct superstructure: RC platform with homogenization zones (a) and steel main beams (b)

The following assumptions were made in the track modelling. The rail-line as well as the rails axis – in the unloading state – is rectilinear. The rails were considered as prismatic beams deformable in flexure and shear, made of linearly viscoelastic material. Layers of the embankment were modelled as a linearly viscoelastic material continuum. Rail fastening systems were simulated using massless 1-D discrete non-linear spring and damper elements. The embankment was reflected by a rectangular prism with unmovable side and bottom boundary surfaces and meshed using 8-node 24 DOF solid elements. Approach slabs are prismatic, modelled as linear viscoelastic isotropic continuum, and supported with non-deformable bearings. Sleepers were modelled as elastic beams vibrating only

vertically using beam elements and respective constraints. The ballast layer was reflected by a vertical set of nonlinear spring and damper elements. The lumped mass distribution for the ballast was put into the bottom set of the nodal points contacting the platform slab and the top subsoil layers. Values of geometrical and mechanical parameters of the ballasted track components were taken from [13–17]. The FE model of the modernized ballasted track in the approach zone is presented in Fig. 4.

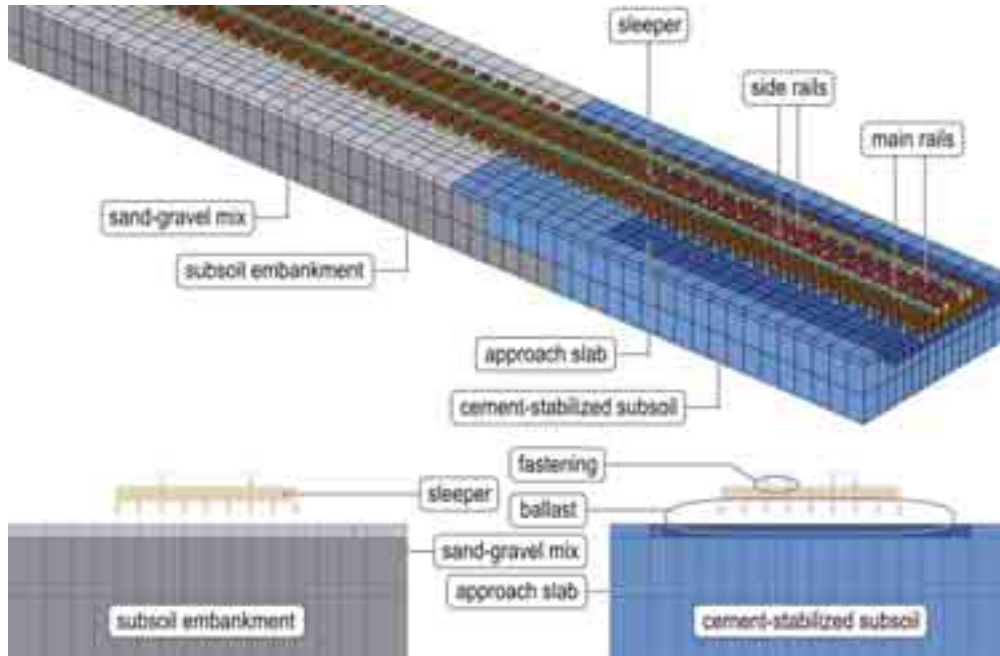

Fig. 4. The FE model of the modernized ballasted track in the approach zone to the bridge

A numerical model of the train consists of the following components: carboodies, bogie frames, wheelsets, vertical massless discrete linear viscoelastic elements reflecting the primary and the secondary suspension systems. A side-view scheme of the 3D model of the power car of the ICE-3 train was shown in Fig. 5. All mass components were modelled using shell and beam elements and were treated as rigid bodies. Vibrations of the train units are symmetric with respect to the main longitudinal vertical plane of symmetry of the BTT system. Respective constraints have been put into the train model via incorporating translational `CONSTRAINED_JOINT_CYLINDRICAL` and rotational `CONSTRAINED_JOINT_REVOLUTE` elements [18].

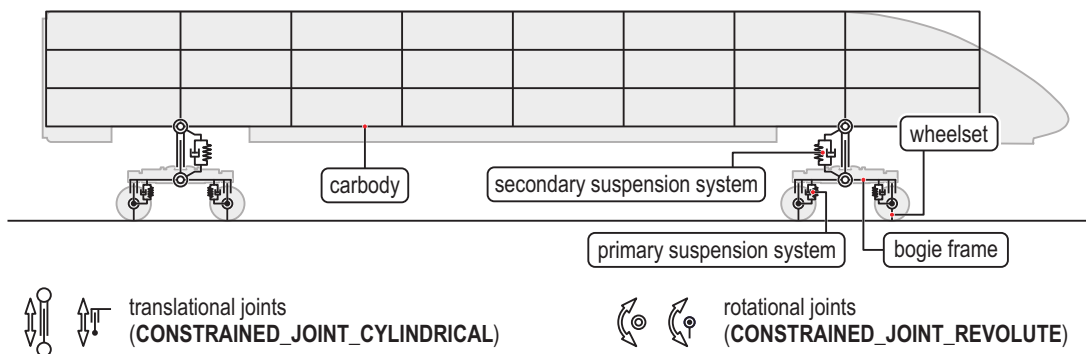

Fig. 5. Side-view scheme of the 3D model of the power car of the ICE-3 train

`RAIL_TRACK` and `RAIL_TRAIN` modules available in LS-DYNA [18] were applied for approximate modelling of the train – track interaction (without simulation of wheels’ rotation). In the simulations, the `DYNAMIC_RELAXATION` option [18] was replaced with loading the system by a set of vertical forces put in the moving vehicle – rail contact points according to the formula:

$$P(t) = \frac{P_0}{2} \left( 1 - \cos \frac{\pi t}{t_0} \right), \quad (1)$$

where  $P_0$  is a static load of a single wheel on the railhead, and  $t_0$  is time of increasing of the static load up to the full value,  $t_0 = 2$  sec ( $0 \leq t \leq 2$  sec).

Service velocities of the vehicle FE model were declared in two steps – with option INITIAL\_VELOCITY for  $t = 0$  and PRESCRIBED\_MOTION\_RIGID for  $t > 0$  [18].

#### 4. Results of the FE analyses

The numerical analyses were carried out using finite element code LS-DYNA. FE model of the high-speed train was moving at 150–300 km/h during those analyses. Measurement points were depicted in Fig. 6. Following values were registered at the midspan:

D1, D2 – deflection of the inner main beam, and the rail, respectively,

S1, S2 – longitudinal normal stress in respectively bottom and upper flange of the inner main beam.

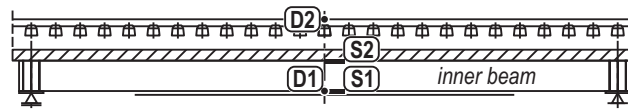

Fig. 6. Locations of the measurement points (nodes and elements) on the viaduct

Extreme values of the vertical deflection and the longitudinal normal stress at the midspan vs. service velocity are presented in Fig. 7 and 8, respectively. It can be observed two resonant velocities in the range from 150 km/h to 300 km/h in both considered viaduct variants. Deflection and stresses are higher for the viaduct before modification. It is obvious since the stiffness of the modernized viaduct is higher due to additional flats welded to the bottom flanges. The fact is that this additional component has significant influence of the viaduct dynamic response. An influence of side rails and approach slabs is rather minor. It was demonstrated in details in one of the previous studies focused on the influence of approach slabs and side rails on dynamic response of the viaduct under high-speed train [19]. Authors proved that these two components slightly modified the viaduct vibrations. The difference in the values obtained for the object with and without approach slabs and side rail did not exceed 0.25 mm for deflection and 1.5 MPa for the stress. The influence of the main beam reinforcement is more significant since the differences equal about 0.5 mm for deflection and 5 MPa for stress. Fig. 9–14 show time histories registered for the maximum service velocity of 300 km/h and for the resonant velocities in both variants 245 km/h and 260 km/h, respectively.

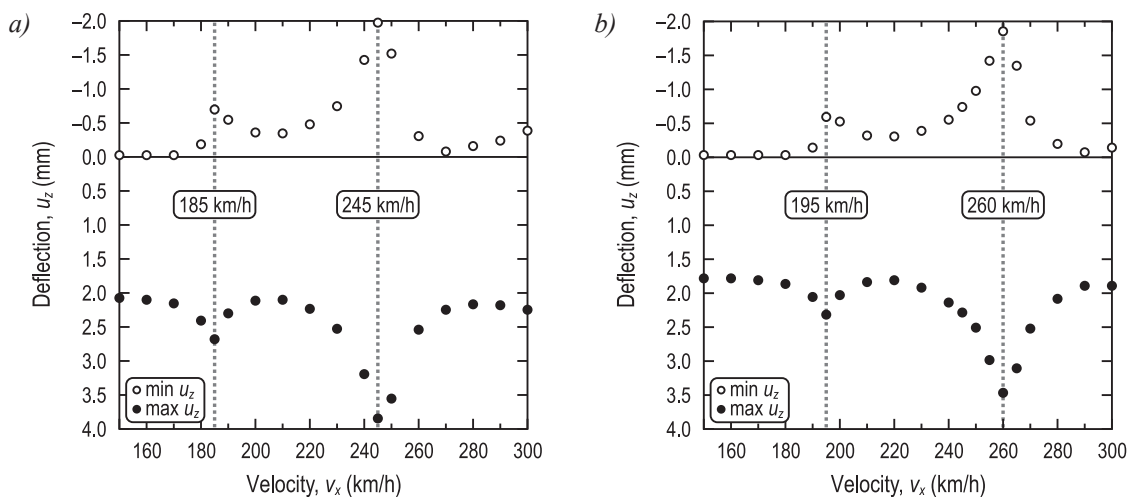

Fig. 7. Extreme values of the vertical deflection (point D1) at the midspan vs. service velocity – variant 1 (a) and 2 (b)

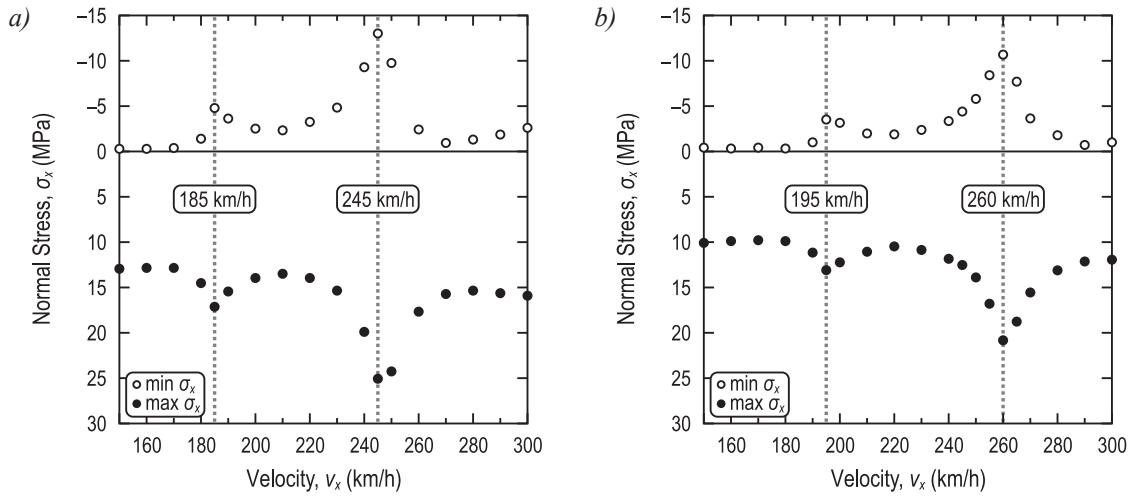

Fig. 8. Extreme values of the normal stresses in the bottom flange of the internal main beam (point S1) at the midspan vs. service velocity – variant 1 (a) and 2 (b)

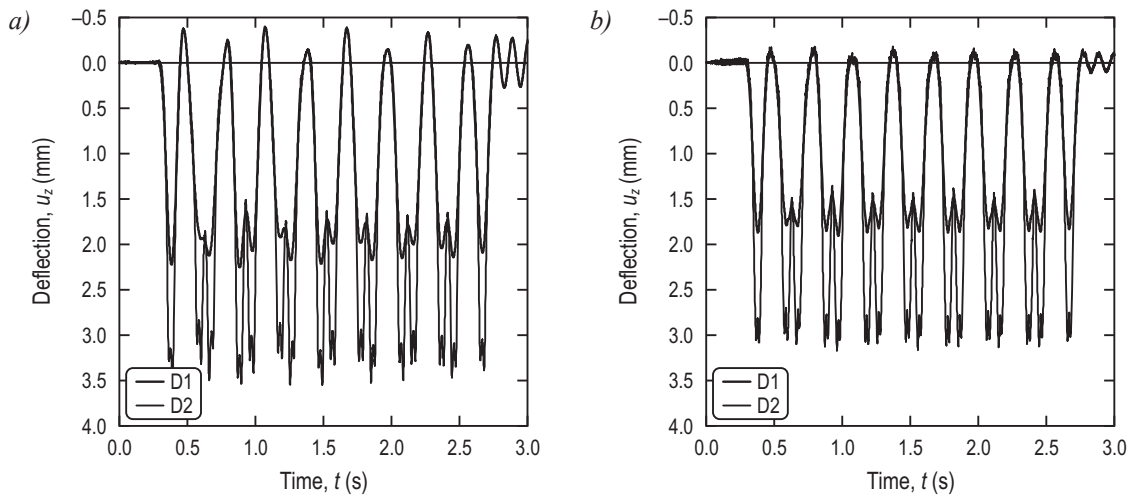

Fig. 9. Time-histories of the vertical displacements at the midspan – variant 1 (a) and 2 (b). Service velocity of 300 km/h – maximum velocity

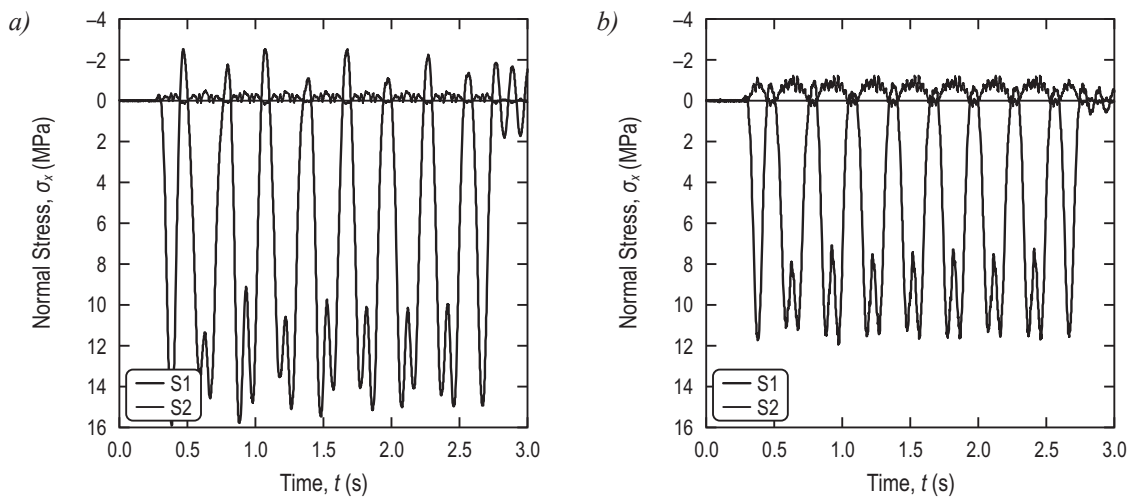

Fig. 10. Time-histories of the normal stresses in the internal main beam flanges at the midspan – variant 1 (a) and 2 (b). Service velocity of 300 km/h – maximum velocity

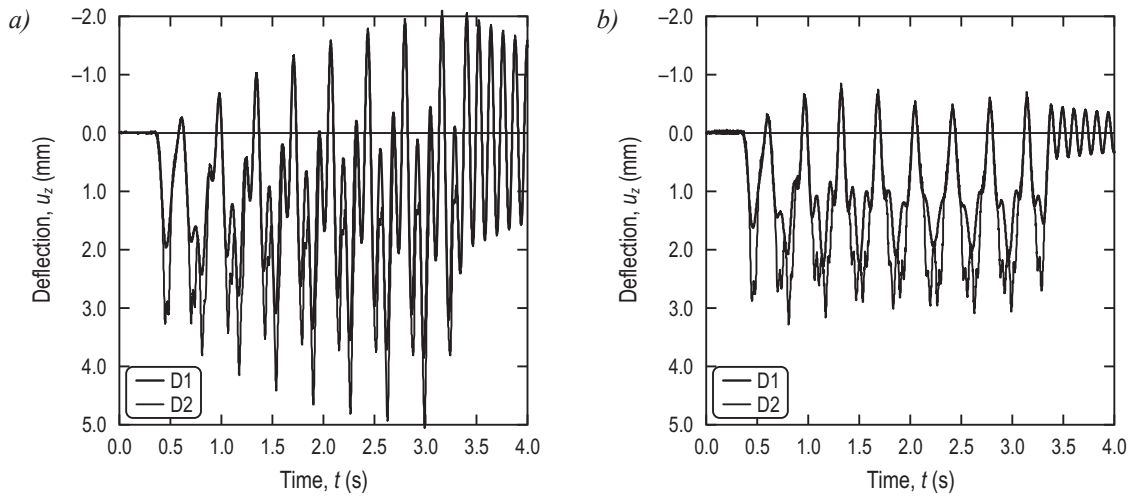

Fig. 11. Time-histories of the vertical displacements at the midspan – variant 1 (a) and 2 (b). Service velocity of 245 km/h – close to the resonant velocity for the variant 1

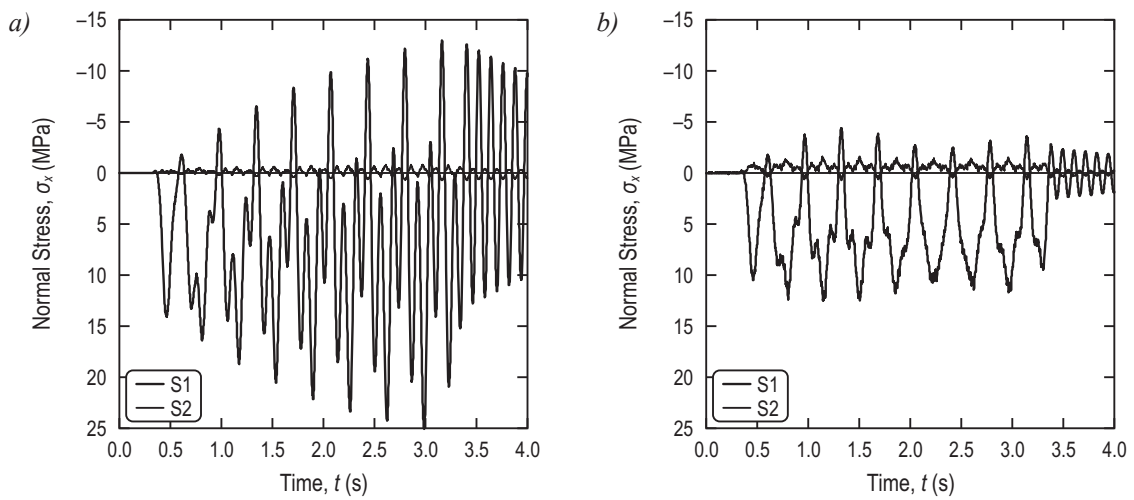

Fig. 12. Time-histories of the normal stresses in the internal main beam flanges at the midspan – variant 1 (a) and 2 (b). Service velocity of 245 km/h – close to the resonant velocity for the variant 1

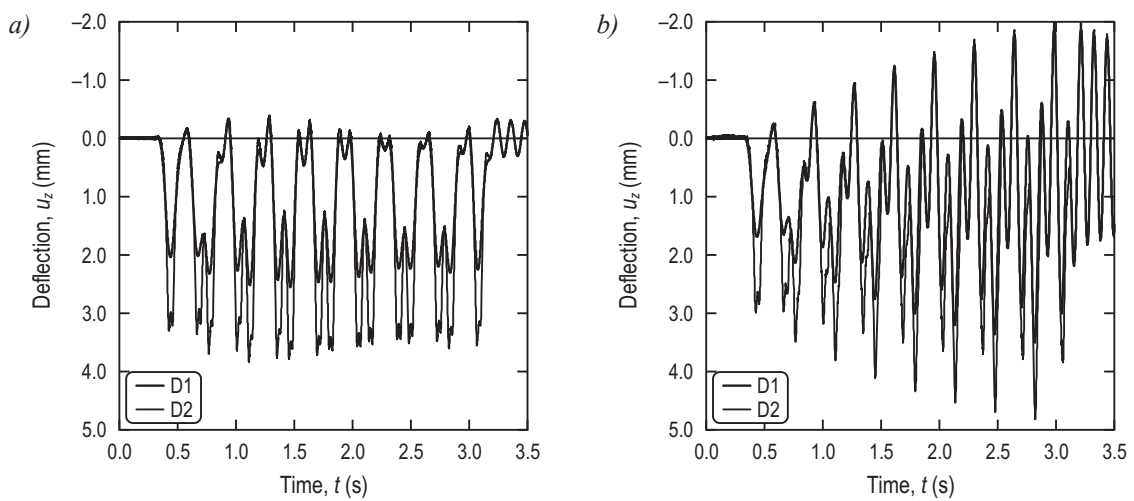

Fig. 13. Time-histories of the vertical displacements at the midspan – variant 1 (a) and 2 (b). Service velocity of 260 km/h – close to the resonant velocity for the variant 2

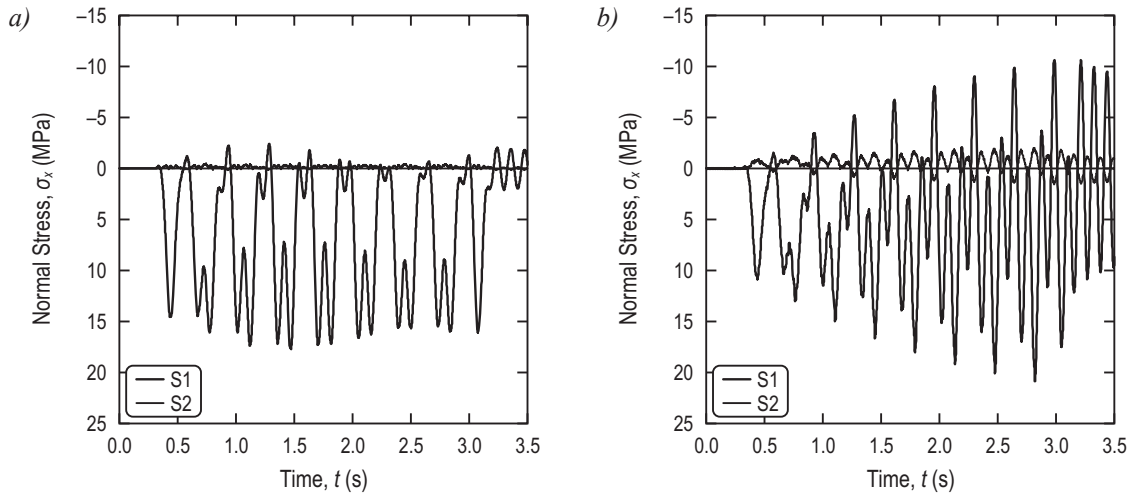

Fig. 14. Time-histories of the normal stresses in the internal main beam flanges at the midspan – variant 1 (a) and 2 (b). Service velocity of 260 km/h – close to the resonant velocity for the variant 2

### 5. Conclusions

The study develops FE modelling and simulation of the composite (steel – concrete) bridge – ballasted track – ICE-3 train system. The numerical analyses presented in the study are related to the KNI 140070 railway viaduct on the Polish Central Main Line, hence the conclusions cannot be generalized. Nevertheless, the results seem to be very credible and useful in engineering practice.

Modernization of the considered viaduct — the modernization carried out in 2008 as well as the theoretical modernization in order to adapt the track to high service velocities — has a noticeable influence on dynamic response of the viaduct. The influence of additional reinforcement of the bottom flanges is much higher than the influence of side rails and approach slabs. Higher stiffness of the viaduct structure results in lower amplitude of the viaduct vibrations. Moreover, it can be observed that the vibrations are more damped in modernized object – vibration amplitudes are lower after the train cross the viaduct.

Obtained stresses and displacements in both considered cases do not exceed the limits. Comparison of the results for both variants is depicted in Fig. 15 – the maximum registered values for deflections (down deflection only) and stresses (tensile stresses only) were taken into account. The differences were relative to the values obtained for the non-modernized variant (Fig. 16).

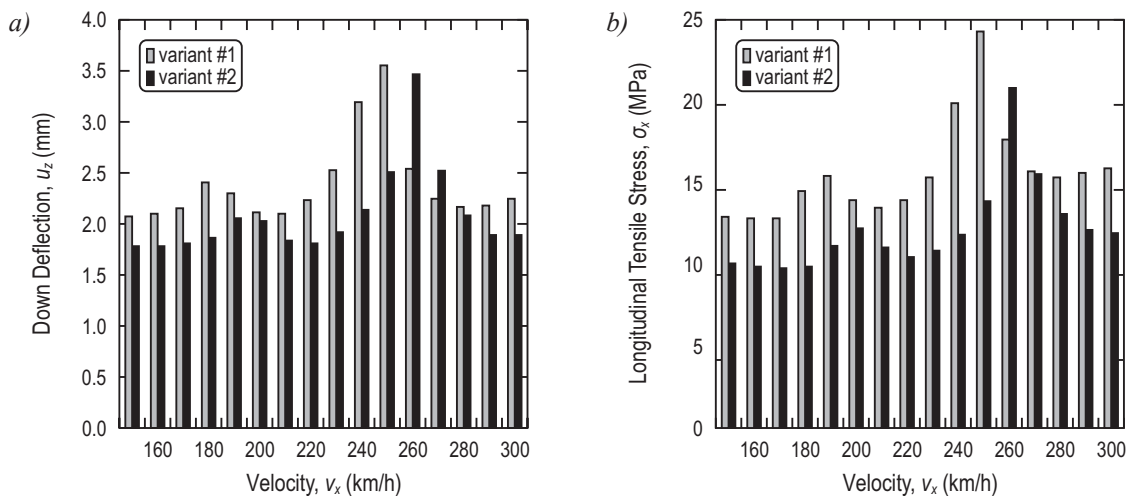

Fig. 15. Comparison of the results for obtained for both variants of the considered viaduct: maximum registered values of deflections (a) and tensile stresses (b)



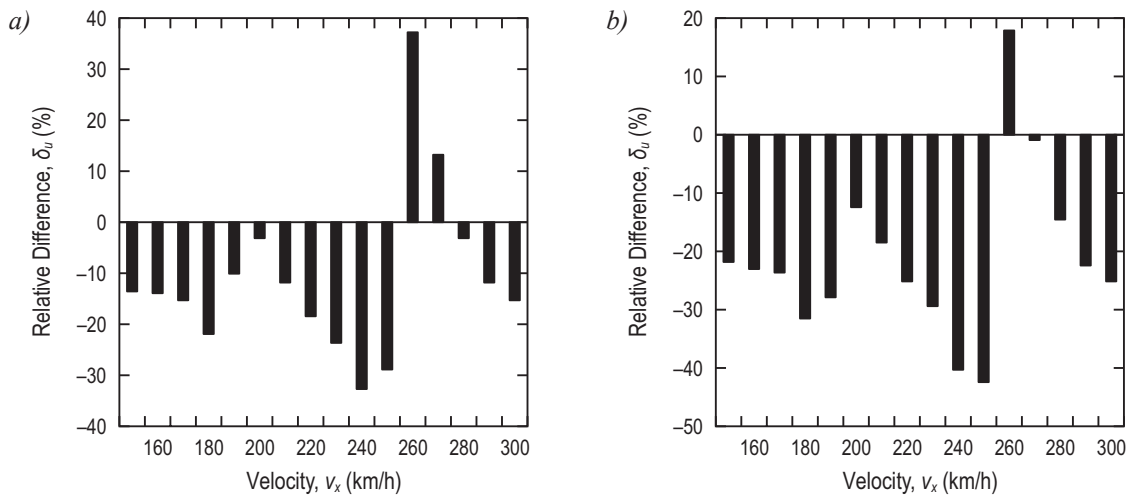

Fig. 15. Relative differences in deflections (a) and tensile stresses (b) between both viaduct variants

It can be seen that the relative differences for the modernized viaduct are about 10–30% lower for the displacements and about 15–40% for the stresses except for the resonant velocities. Summing up, the results of analyses show that the modernization — the actual and the theoretical one as well — generally reduces the vibrations and improves the behaviour of the object. Vibration amplitudes are smaller and the vibrations are quickly damped.

### Acknowledgements

Thanks are due to Prof. Marian Klasztorny from the Department of Mechanics and Applied Computer Science at the Military University of Technology for his guidance, comments and constant support.

### References

- [1] Yang, Y.-B., et al., *Vibrations of Simple Beams Due to Trains Moving at High Speeds*, Engineering Structures, Vol. 19, No. 11, pp. 936–944, 1997.
- [2] Cheng, Y.S., et al., *Vibration of Railway Bridges Under a Moving Train by Using Bridge – Track – Vehicle Element*, Engineering Structures, Vol. 23, No. 12, pp. 1597–1606, 2001.
- [3] Au, F. T. K., et al., *Impact Study of Cable-Stayed Bridge Under Railway Traffic Using Various Models*, Journal of Sound and Vibration, Vol. 240, No. 3, pp. 447–465, 2001.
- [4] Zhang, Q.-L., et al., *Numerical Simulation of Train – Bridge Interaction Dynamics*, Computers and Structures, Vol. 79, pp. 1059–1075, 2001.
- [5] Song, M. K., Choi, C. K., *Analysis of High-Speed Vehicle-Bridge Interactions by a Simplified 3-D Model*, Structural Engineering and Mechanics, Vol. 13, No. 5, pp. 505–532, 2002.
- [6] Bojanowski, C., Kulak, R. F., *Seismic and Traffic Load Modeling on Cable Stayed Bridge*, Paper No. 11-2553, 90th Transportation Research Board Annual Meeting, Washington, D.C., January 23-27, 2011.
- [7] Szurgott, P., *Modelling and Numerical Analysis of the Reinforced Concrete Viaduct Under the Eurocity EC-114 Train*, Journal of KONES Powertrain and Transport, Vol. 19, No. 2, pp. 515–524, 2012.
- [8] Klasztorny, M., Szurgott, P., *Modeling and Simulation of Bridge – Track – Train Systems at High Service Velocities with LS-DYNA®*, 12th International LS-DYNA Users Conference, Dearborn, MI, United States 2012.
- [9] Szurgott, P., Klasztorny, M., Grosel, J., Wójcicki, Z., *Experimental Validation of Numerical Modelling of the Bridge – Track – Moving Train System*, WIT Transactions on Modelling and Simulation, Vol. 51, pp. 97–109, 2011.

- [10] Szurgott, P., Klasztorny, M., Niezgoda, T., *Modelling and Numerical Simulation of Symmetric Vibrations of the KNI 140070 Viaduct – Ballasted Track – KTX Train System*, Journal of KONES Powertrain and Transport, Vol. 17, No. 3, pp. 415–422, 2010.
- [11] *Modernization of the Rail-Line 4 –E 65. Viaduct No. KNI 140070*. Building Project [in Polish], Warsaw, Poland 2007.
- [12] Jones, R. M., *Mechanics of Composite Materials*, Taylor & Francis, London 1999.
- [13] Klasztorny, M., *Vibrations of Single-Track Railway Bridges Under High-Speed Trains* [in Polish], Wroclaw University of Technology Press, Wroclaw, Poland 1987.
- [14] Klasztorny, M., *Dynamics of Beam Bridges Loaded by High-Speed Trains* [in Polish], WNT, Warsaw, Poland 2005.
- [15] Niemierko, A., et al., *Reinforcing the Track and the Subgrade in the Approach Zones to Engineering Objects* [in Polish], Project No. M1-123, Research Institute for Roads and Bridges, Warsaw, Poland 2009.
- [16] <http://kolej.krb.com.pl/dt/zal1.htm>
- [17] Polish Standard: PN-H-84027-07:1984. *Steel for Rail-Engineering. Normal Rails. Sorts* [in Polish], PKN, Warsaw, Poland 1984.
- [18] Hallquist, J. O., *LS-DYNA® V971 R4 Beta. Keyword User's Manual*, LSTC Co., CA, USA 2009.
- [19] Szurgott, P., Kozera, D., *The Influence of Approach Slabs and Side Rails on Dynamic Response of the Viaduct Under a High Speed Train* [in Polish], Engineering Modelling, 2012 [in press].