

MATHEMATICAL MODEL PHASES OF FUEL INJECTION IN THE SPARK - IGNITION ENGINE WITH DIRECT FUEL INJECTION DURING WORK ON THE HETEROGENEOUS MIXTURE

Bronisław Sendyka

*Kraków University of Technology
Institute of Automobiles and Internal Combustion Engine
Warszawska Street 24, 31-155 Kraków, Poland
e-mail: bsendyka@usk.pk.edu.pl*

Mariusz Cygnar, Karina Janisz

*State Higher Vocational School in Nowy Sącz
Staszica Street 1, 33-300 Nowy Sącz
e-mail: mcygnar@pwsz-ns.edu.pl*

Abstract

The paper presents the methods and results of calculation of time necessary for transmission of a jet of stratified charge from the injector to the gap between the electrodes of the ignition plug which is the basis for determination of the advance angle of fuel injection in relation to the advance angle of ignition. This time is the sum of duration of four phases of load jet way and is calculated basing upon a number of empiric formulae taken from recent publications. Constructors of gasoline engines are faced with higher and higher requirements as regards ecological problems and increase in engine efficiency at a simultaneous decrease in fuel consumption. Satisfaction of these requirements is possible due to recognition of the phenomena occurring inside the engine cylinder, choice of suitable optimal parameters of the fuel injection process, and determination of geometrical shapes of the combustion chamber and piston head. Increase of engine efficiency is connected, first of all, with the changes in fuel supply, it means a proper regulation of fuel - air mixture in dependence on the rotational speed and load; hence, combustion of stratified mixtures in a gasoline engines with direct fuel injection is essential for increase in efficiency with a simultaneous decrease in emission of toxic components of exhaust gases and fuel consumption. Such a kind of supply systems show that, apart from combustion of very lean mixtures a gasoline engine with direct fuel injection possesses many other advantages, i.e.: fuel consumption comparable with other engines with self - induced ignition, greater power than in other spark ignition engines with multi - point fuel injection. The results of the performed analysis were given in two-dimensional diagrams.

Keywords: *transport, internal combustion engine, fuel injection system*

1. Introduction

Constructors of gasoline engines are faced with higher and higher requirements as regards ecological problems and increase in engine efficiency at a simultaneous decrease in fuel consumption. Satisfaction of these requirements is possible due to recognition of the phenomena occurring inside the engine cylinder, choice of suitable optimal parameters of the fuel injection process, and determination of geometrical shapes of the combustion chamber and piston head.

All these parameters influence significantly improvement of gasoline engine performance and improve their efficiency. Increase of efficiency is connected, first of all, with the change in fuel supply, it means a proper regulation of fuel - air mixture in dependence on the rotational speed and load; hence, combustion of stratified mixtures in a gasoline engines with direct fuel injection is essential for increase in efficiency with a simultaneous decrease in emission of toxic components

of exhaust gases and fuel consumption.

Such a kind of supply systems show that, apart from combustion of very lean mixtures a gasoline engine with direct fuel injection possesses many other advantages, i.e.:

- fuel consumption comparable with other engines with self - induced ignition,
- greater power than in other spark ignition engines with multi - point fuel injection.

Engine constructors aim, first of all, at increasing the value of total efficiency, and not only of one of the constituting partial efficiencies; hence a thorough analysis of the above mentioned factors decisive for its real value is justified.

2. Calculation of periods of phases of fuel injection in the spark - ignition engine with direct fuel injection during work on the heterogeneous mixture

Carried out calculations aim at determination of durations of particular phases of injected fuel stream in the Mitsubishi GDI engine during work on the stratified mixture, including resistances prevalent inside the cylinder. The mathematical model was elaborated by use Programme Mathcad 2006 Professional.

For the calculation model, the total time needed to cross a distance from injection moment to the sparking plug points reaching was divided into four stages (Fig. 1), namely:

1. Period t_1 - from the fuel injection moment to contact of the stream with the piston head, including air resistance,
2. Period t_2 - from the moment of entry into curvature of the piston head to the half-length of the curvature, including frictional resistance between the fuel stream and the piston head,
3. Period t_3 - from the half-length of the piston head curvature to the moment when the fuel stream exits the head, including both frictional and air resistance's for the evaporating fuel,
4. Period t_4 - from exit the curvature of the piston head to the moment when the fuel stream reaches the sparking plug points.

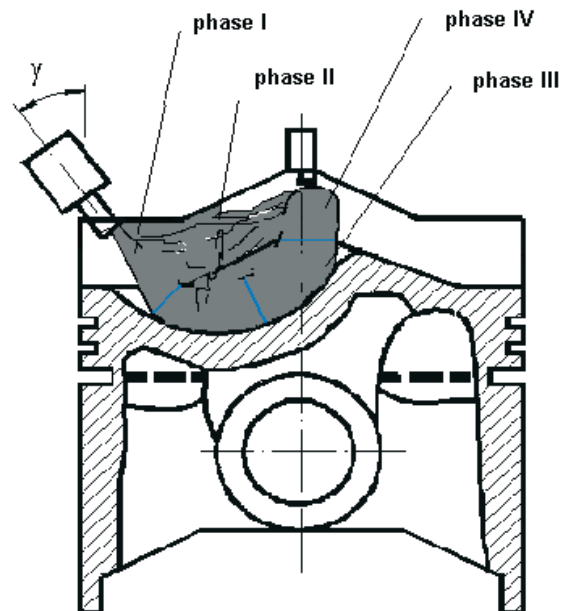

Fig. 1. The phases of injected fuel stream during work on the stratified charge

Parameters of fuel injector

- mounting angle of injector $\gamma=36^\circ$,
- diameter of fuel injection nozzle $d_0=0.20$ [mm],
- gasoline injection pressure $P=5$ [MPa],
- coefficient of injector speed $\varphi=0.7$,

- fuel density ρ ,
- cylinder pressure - P_C ,
- fuel speed at nozzle mouth of injector V_0 :

$$V_0 = \phi \cdot \sqrt{2 \cdot \frac{P - P_C}{\rho}}. \quad (1)$$

2.1. Conditioning the coefficient of turbulence „a” to the path gone by fuel stream running out of injector

The speed of injected fuel stream obtained through experiment is presented in Fig. 2.

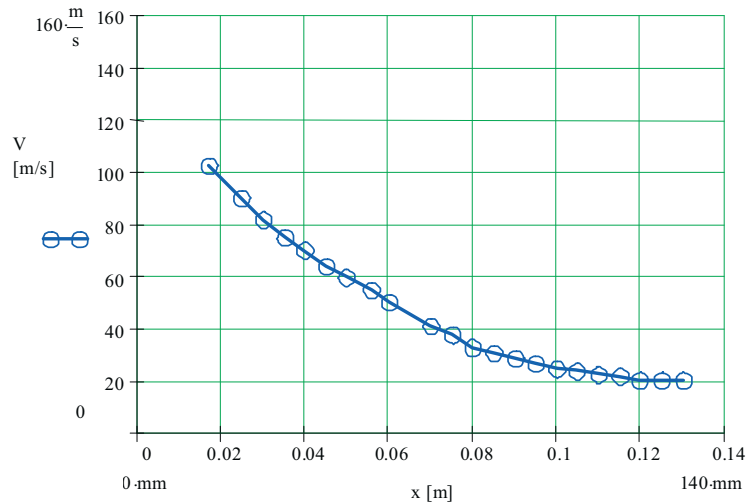

Fig. 2. Empirical speed of injected fuel stream in relation to its path crossed

A relation determined by equation (2.2) is being fitted through approximation. The results of approximation are shown in Fig. 3.

$$V_S(s) = S_1 + S_2 \cdot (2 \cdot e)^{-s \cdot 0.016}, S_1, S_2 = \text{const}. \quad (2)$$

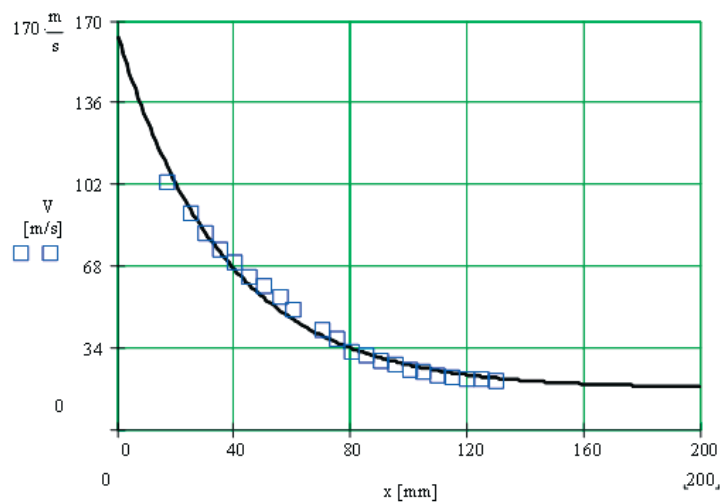

Fig. 3. The speed of fuel injected to piston in relation to path after approximation

2.2. Determination the coefficient of turbulence „a” in relation to the path

Comparison of speed calculated from Prandtl’s model to empirical speed enables to obtain the coefficient of turbulence „a” according to equation:

$$V_s(s) = \frac{V_s(0) \cdot d_0}{2 \cdot \sqrt{2} \cdot a \cdot s} \quad (3)$$

Results of calculation are presented in Fig. 4.

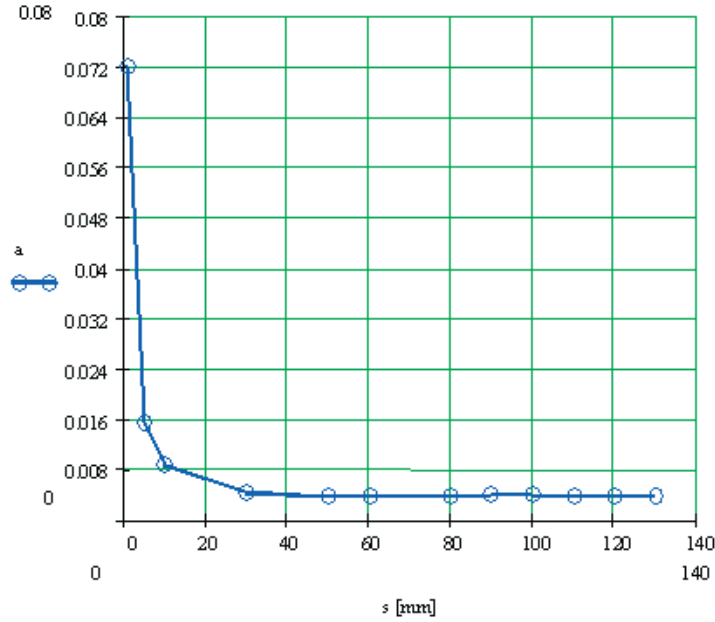

Fig. 4. The coefficient of turbulence „a” in relation to path s

Next a fitting function of turbulence coefficient a(s) was made. The function is determined by equation:

$$a(s) = S_a + S_b \cdot \frac{1}{s} \quad (4)$$

Results of approximation are presented in Fig. 5.

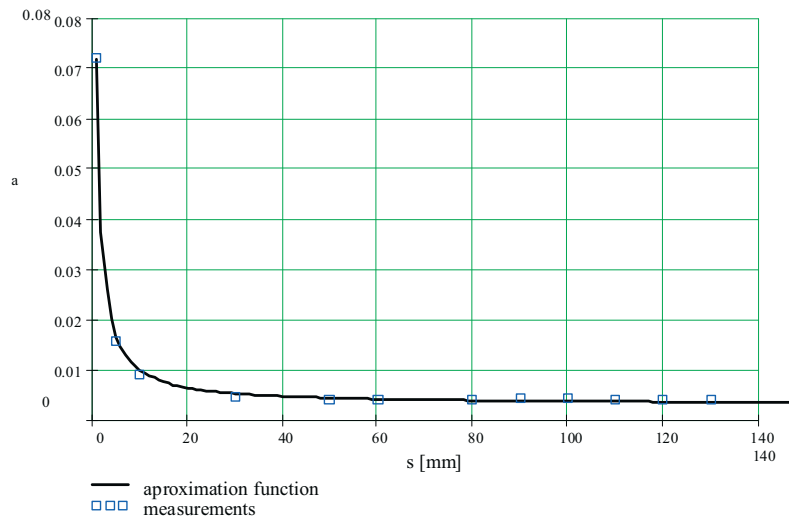

Fig. 5. The coefficient of turbulence „a” in relation to path s - results of approximation

3. Calculation of total time t₅

Total time - which the fuel stream takes to go from the injection to the moment when it reaches the sparking plug for the pressure 10 [MPa]:

$$t_5 = t_1 + t_2 + t_3 + t_4 \quad (5)$$

Results of time t_5 are shown in the Fig. 6.

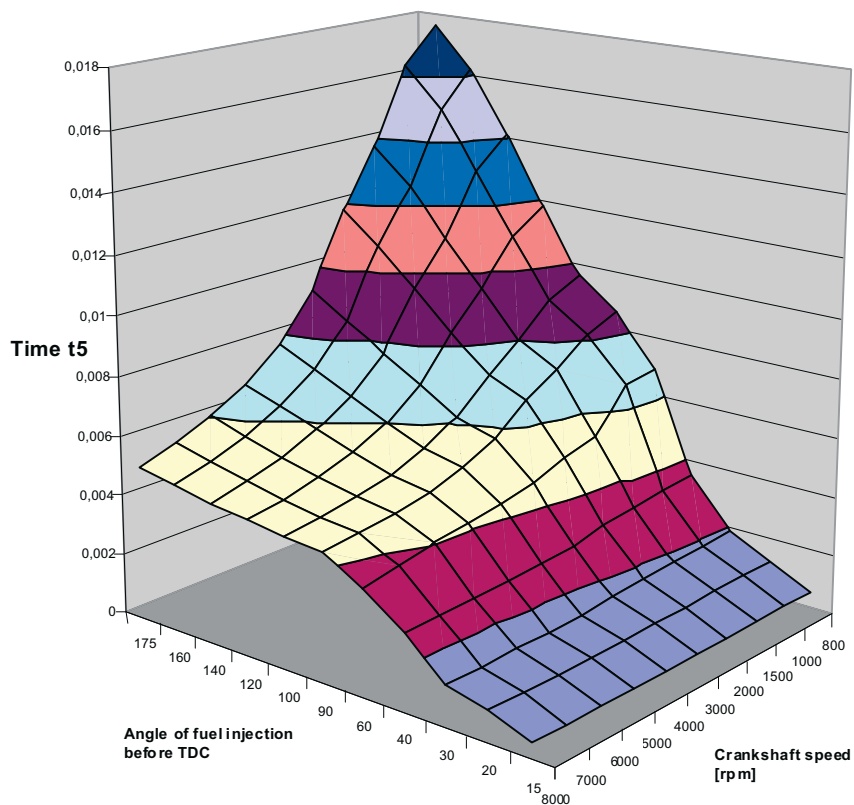

Fig. 6. Total time for the injection pressure 10 [MPa]

Basing upon the calculated time of injection necessary for the fuel jet to pass the way from the moment of leaving the injector till reaching the electrodes of the spark plug the value of the angle by which the crankshaft revolts at a given rotational speed is calculated:

$$U = 6n \cdot t_5 . \quad (6)$$

From the calculated values of the angle by which the crankshaft revolts during the jet travel the value of the advance angle of injection with consideration of the advance angle of ignition is calculated.

It has to be emphasized that the actual injection angle has to be increased by the ignition advance angle what is superposed and presented in Fig. 7.

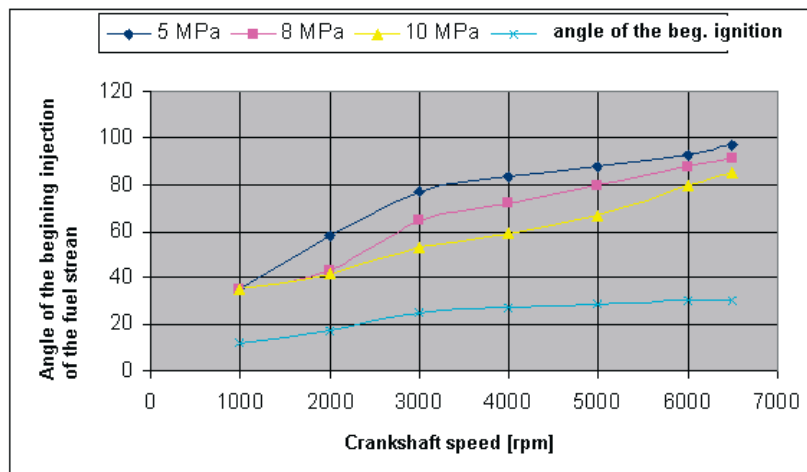

Fig. 7. Actual injection advance angle as a function of rpm for different values of injection pressure

4. Conclusion

Mathematical model and results of calculation of time necessary for transmission of a jet of stratified charge from the injector to the gap between the electrodes of the ignition plug which is the basis for determination of the advance angle of fuel injection in relation to the advance angle of ignition. This time is the sum of duration of four phases of load jet way and is calculated basing upon a number of empiric formulae taken from recent publications.

5. References

- [1] Evers, L. W., *Characterization of the Transient Spray from a High Pressure Swirl Injector*, SAE Papers, No. 940188, 2000.
- [2] Kano, M., Saito, K., Basaki, M., Matsushita, S., Gohno, *Analysis of Mixture Formation of Direct-Injection Gasoline Engine*, Gasoline Direct Injection Engine SAE International Congress, USA 2000
- [3] Lefebvre, A. H., *Atomizations and Sprays*, Hemisphere Publishing Corporation, 1989
- [4] Rizk, N. K., Lefebvre, A. H., *Internal Flow Characteristics of Simplex Swirl Atomizers*, AIAA, J. Propul. Power, 1, 193, 1985.
- [5] Xu, M., Markle, L. E., *CFD-Aided Development of Spray for an Outwardly Opening Direct-Injection Gasoline Injector*, Gasoline Direct Injection Engine SAE International Congress, USA 2000.

"The author's reward was sponsored by Society of Collective Management of Copyrights of Creators of Scientific and Technical Works KOPIPOL with registered office in Kielce with duties obtained on the ground of the art. 20 and art. 20¹ of law on copyrights and related rights."