

TRIBOLOGICAL PROPERTIES OF THE SEAT INSERT - VALVE - GUIDE ASSEMBLY FOR VALVE DRIVEN MAGNETOELECTRICALLY

Krzysztof Siczek, Krystian Siczek

*The Technical University of Lodz, The Chair of Precise Design
Stefanowskiego Street 1/15, 90-924 Lodz, Poland
tel.: 042 631 22 50, fax: 042 631 22 52
e-mail: ks670907@p.lodz.pl*

Abstract

The researches have been carried out, where the object has been the set of two friction couples: valve stem – valve guide and valve seat – seat insert. The camless driven valve has been common for each of such cases. The analyzed valve has been driven by magneto-electrical drive. The special research stand has been elaborated and its scheme has been presented in the article. It has been measured the valve lift and valve acceleration, the impact force, the friction force, temperature values for valve guide and for seat insert, sound level during impacting on the stand. The aim of researches has been to determine the dynamic parameters, the friction force between valve stem and valve guide, the impact force for valve impacting seat insert vs. frequency and valve lift. The analyzed valves have mated with seat inserts and valve guides made of cast iron, in oil absence. The valves have been made of TiAl6Zr4Sn2Mo2 alloy. The researched friction couples have operated in temperature equal 293 K. The increase of frequency has resulted in small changes for values of lift and in greater changes of acceleration, during valve impact into its seat insert. The greatest values of impact force and acceleration have been for the small, middle and high values of valve lift, either. The ratio of impact force and valve acceleration has changed in thin bands. The friction force has decreased slightly with frequency increase and has decreased with valve lift increase. The sound level has increased with the frequency increase, and has not been dependent upon valve lift.

Keywords: *combustion engine, valve timing, seat insert, valve guide, magneto-electrical drive*

1. Introduction

The camless valve trains have more often been used in modern combustion engines. The camless valve train can be realized using electromechanic [1, 2, 4, 7], magneto-electric [9], electrohydraulic [5, 6, 8] or electropneumatic [3] drivers, to replace the standard camshaft. In the article magneto-electric drives have been analyzed.

The aim of researches has been to determine the dynamic parameters, the friction force between valve stem and valve guide, the impact force for valve impacting seat insert, for camless valvetrain. The object of researches has been a set of two tribological couples: the valve stem - valve guide one and the valve seat – seat insert one. The valve has been common for each of tribological couples. Analyzed valves have been made of TiAl6Zr4Sn2Mo2 alloy. The hardness of surfaces for valve stem and for valve seat has been equal 52 HRC, for valves of the KTM motorcycle engine. The roughness of surface for valve stem has been equal 0.6 μm , and for valve seat has been equal 0.8 μm . The analyzed seat inserts have been made of cast iron. The hardness of surface for seat insert has been equal 200 HB. The valve guides have been made of cast iron either. The hardness of surface for valve guide has been equal 200 HB. Analyzed tribological couples have operated in the conditions of the temperature value equal 293. The researched valves have mated with valve guide and seat insert without any oil.

The following measuring serie has been done during described researches:

The valve has been fixed into the moving coil of drive. The frequency has been equal (6.4-32) Hz, with a step equal 3.2 Hz and values of the valve lift equal 2.4, 4, 5.6 mm. The value of temperature for valve, valve guide and seat insert has been equal 293 K. It has been measured the values of

valve lift, of the drive coil – valve assembly acceleration, of the impact force and of the friction force, and additionally of the sound level.

2. The research stand

The scheme of the research stand for the measurement of valve lift and valve acceleration, of the impact force, of the friction force, of temperature values for valve guide and for seat insert, of sound level during impacting has been presented in the Fig. 1.

The stand has been calibrated, with the help of weights tested by the piezoelectric balance, with accuracy of 0.5 g. It has been calibrated the lines for the measurement of the friction force and of the impact force. During registration of measured voltages by A/C cart on the computer disc, the sensors of measurement lines have been loaded by weights. The results of calibration have been presented in the Fig. 2 and 3. The lines for measurement of valve lift and valve acceleration have had their characteristics determined by manufacturer. The line for valve lift has had the characteristic 2 mm/V and for the valve acceleration 0.008 V/1g respectively.

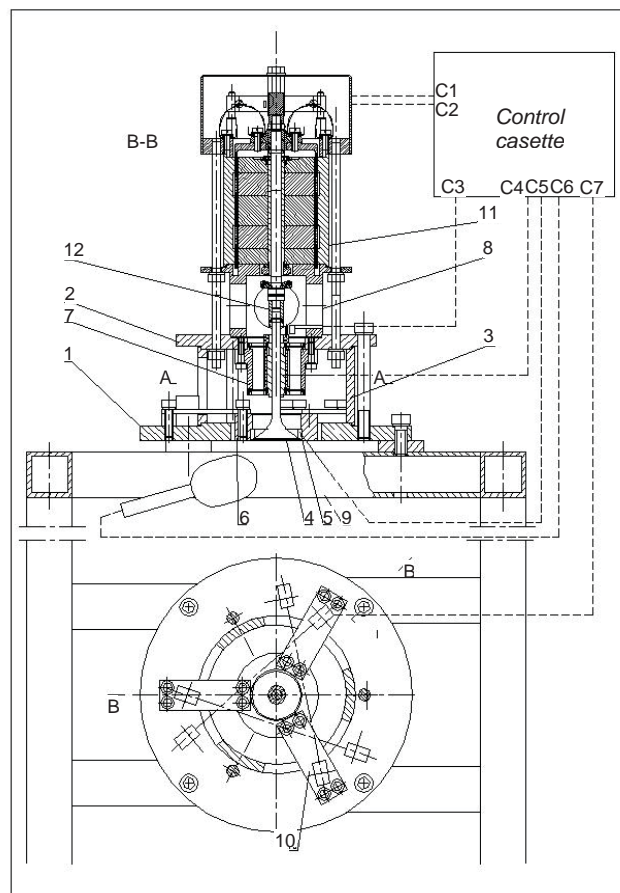

Fig. 1. The scheme of the research stand: 1 - base, 2 - cover, 3 - case sleeve, 4 - valve, 5 - seat insert, 6 - sleeve of seat insert, 7 - valve guide assembly, 8 - cantilever, 9 - frame, 10 - flat spring, 11 - driving assembly, 12 - connector, C1 - valve lift sensor, C2 - valve acceleration sensor, C3 - sensor of friction force between valve and valve guide, C4 - valve guide temperature sensor, C5 - seat insert temperature sensor, C6 - sound level meter, C7 - impact force sensor for valve impacting seat insert

3. Results for the measurement of the noise level

The mean values of the level of the measured sound vs. frequency, for the valve lift equal 2.4, 4, 5.6 mm and value of temperature for valve guide and seat insert equal 293 K have been presented in the Fig. 4.

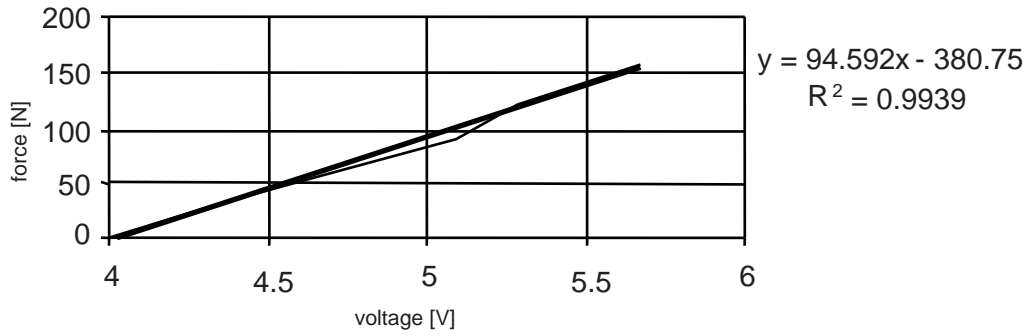

Fig. 2. The dependency of friction force on the registered voltage, for valve stem mating valve guide

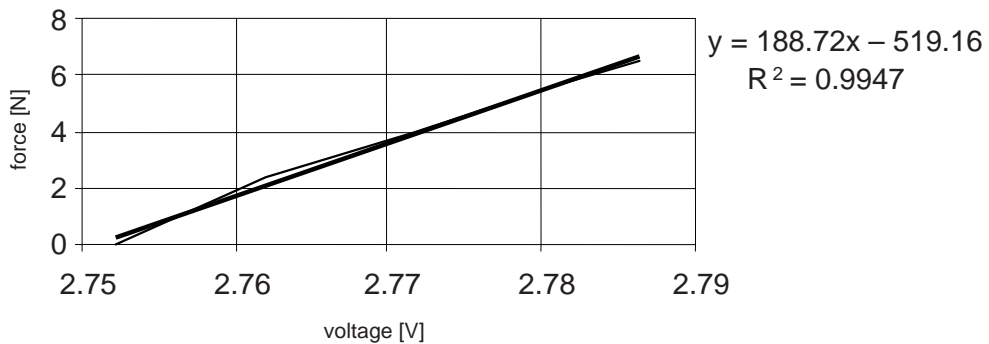

Fig. 3. The dependency of the impact force on the registered voltage for the valve impacting its seat inserts

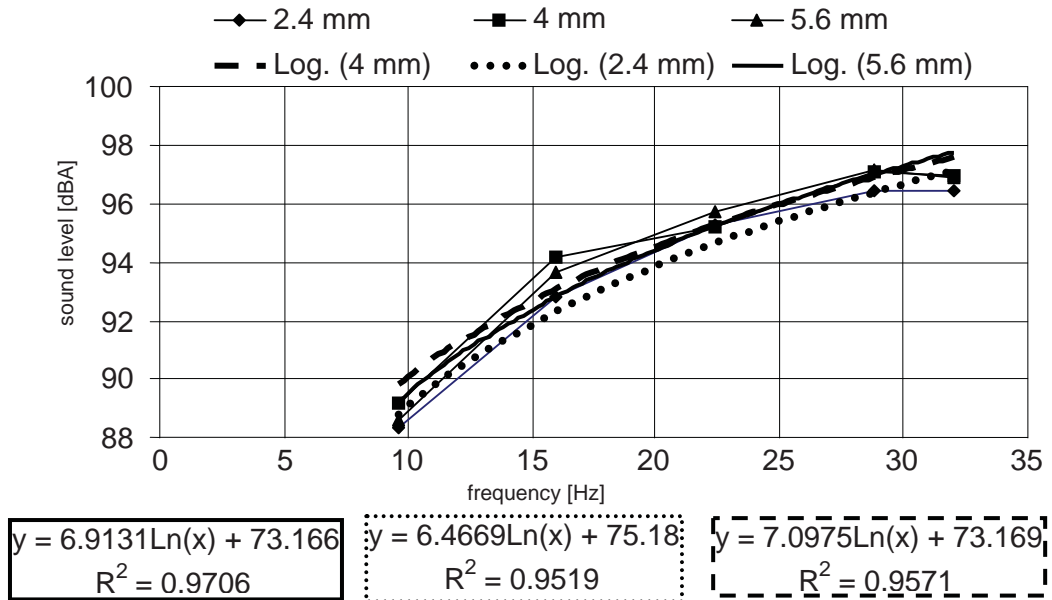

Fig. 4. The course of the mean sound level vs. frequency and valve lift

4. Results of measurement of valve lift and valve acceleration, of the impact force for valve impacting seat insert, of the friction force between valve and valve guide

The sample course of the measured valve lift vs. time has been presented in the Fig. 5. The start point for the valve lift has been assumed, when the calculated valve lift has reached the level of line numbered 1. The level has been calculated as the mean position in the zone of the maximal

valve lift, around such position there have existed vibrations of the small amplitude. The end point for the valve lift has been assumed, when the calculated valve lift has reached the level of line numbered 2. The level has been calculated as the mean position in the zone of the contact between the valve and its seat insert, around such position there have existed vibrations of the small amplitude, either.

The sample course of the measured valve acceleration vs. time has been presented in the Fig. 6. From the measured values of acceleration, the most important value has been one for the moment of the valve impacting into seat insert. That value multiplied times the mass for the moving coil of the drive – connector – valve assembly allows to determine the value of force existing after the valve impact into its seat insert. Such value of force is nearly equal the one of the impact force when valve impacts its seat insert.

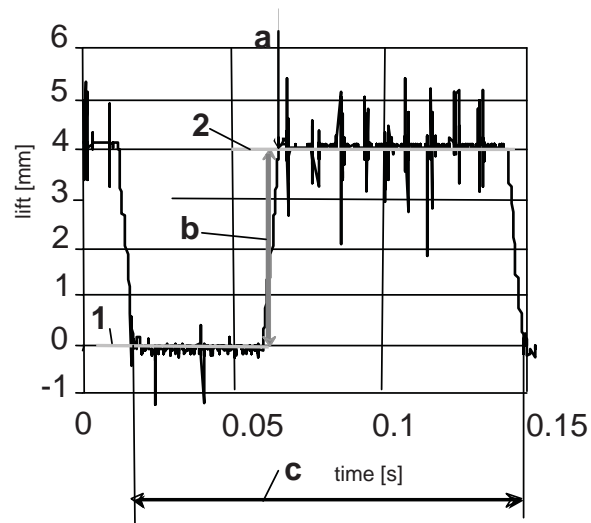

Fig. 5. Measured valve lift vs. time; a – the place of valve impact into its seat insert, b – required maximal valve lift, c – duration of the valve cycle 1, 2 – number of lines

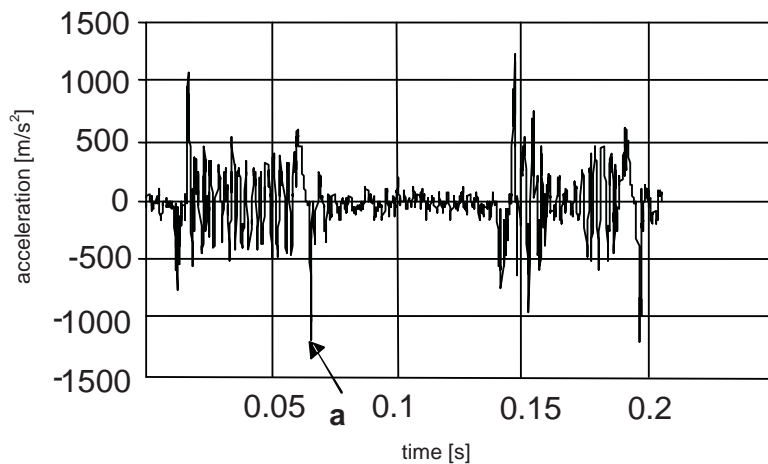

Fig. 6. Measured valve acceleration vs. time; a – valve acceleration at the moment of impacting into seat insert

The measurement of impact force for valve impacting its seat insert has been made in the calibrated line, measuring voltage values. Such values have been multiplied times the factor from the calibration characteristic for the measuring line and have been presented in Fig. 7. The impact force has been calculated as the difference between the level of line numbered 2 corresponding to the maximal measured value of force and the level of line numbered 1 corresponding to the mean position, in the zone of the maximal valve opening, around such position there have existed

vibrations of the small amplitude. The force allowing the valve to stay in contact with the seat insert has been calculated as the difference between the level of line numbered 3 corresponding to the mean position, in the zone of the valve close, around such position there have existed vibrations of the small amplitude and the level of line numbered 1.

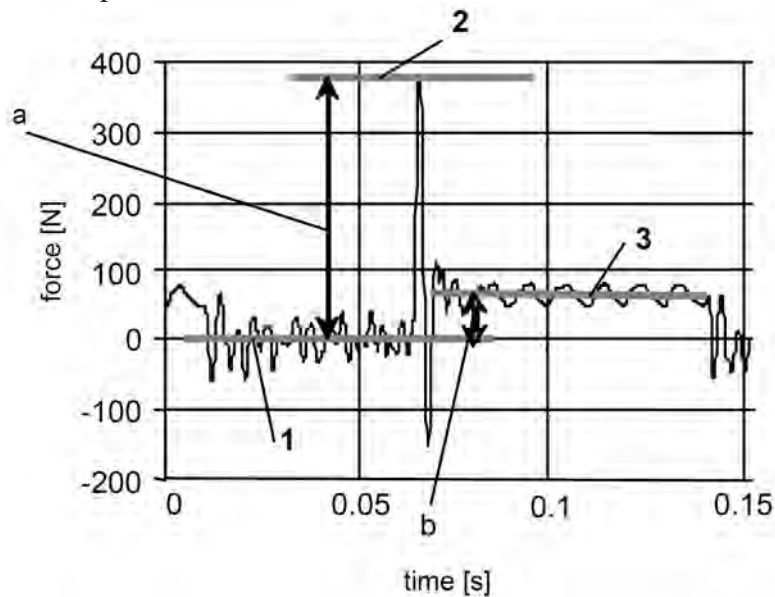

Fig. 7. Measured impact force for valve impacting seat insert vs. time; a – the impact force for valve impacting its seat insert, b – the force holding the valve in contact with its seat insert, 1, 2, 3, - numbers of lines

The measurement of friction force between valve and valve guide has been made in the calibrated line, measuring voltage values. Such values have been multiplied times factor obtained from calibration characteristic for the measuring line and presented in the Fig. 8. For the comparison the maximal value of the friction force has been chosen, which value has been calculated for the period before the moment of valve impact into its seat insert. Such period has been the least sensitive one for the occurrence of rapid increases of the friction force. Such force increase could result from rapid skews of valve in respect to valve guide or from possible voltage increase in measuring line for the friction force. Measured values of friction force have been filtered (averaged every 10 values), to limit the influence of such rapid increases of values.

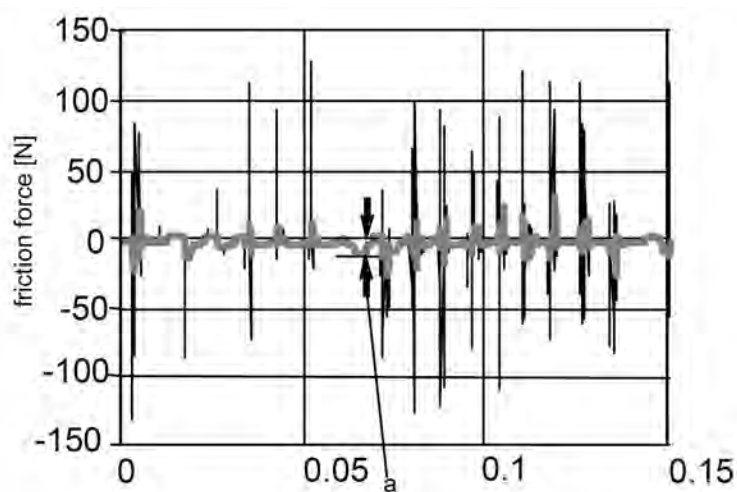

Fig. 8. Measured friction force between valve steam and valve guide vs. time; a – comparative friction force

The results of researches, for the valve lift equal 2.4 mm and temperature value for valve guide equal 293 K, have been presented in Fig. 9-13.

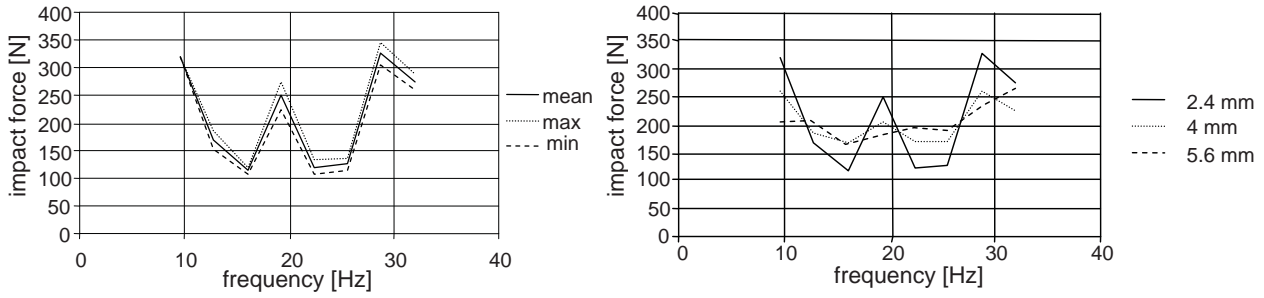

Fig. 9. The impact force, for the valve impacting the seat insert vs. frequency and valve lift; A – for valve lift equal 2.4 mm, B – for valve lift equal 2.4, 4, 5.6 mm

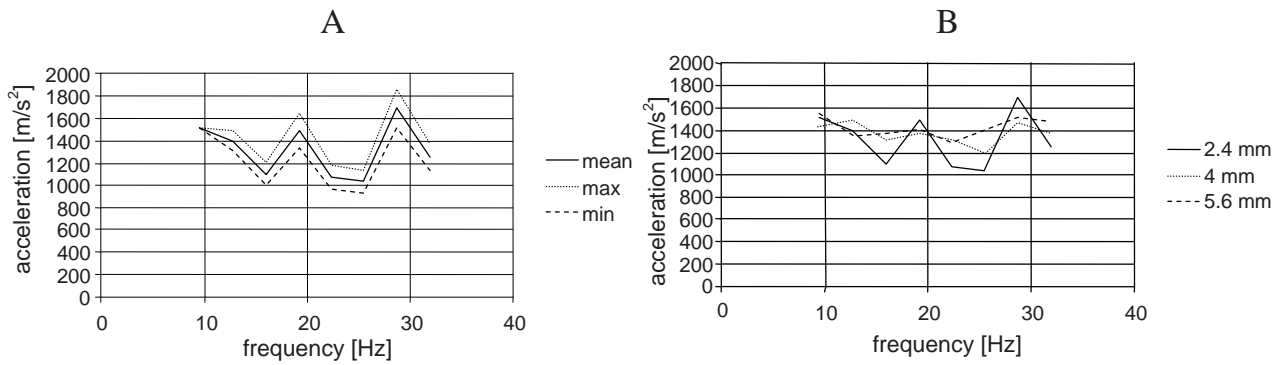

Fig. 10. Valve acceleration after the impact of valve into seat insert vs. frequency and valve lift; ; A – for valve lift equal 2.4 mm, B – for valve lift equal 2.4, 4, 5.6 mm

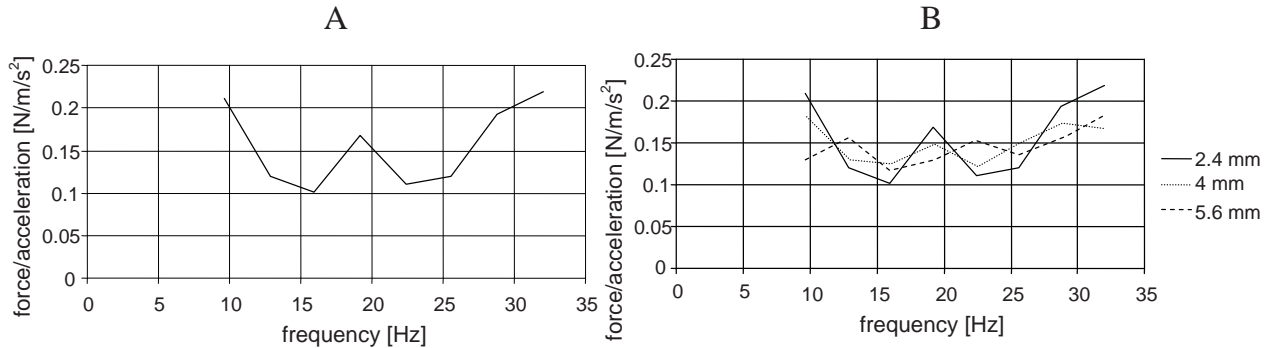

Fig. 11. Ratio of the impact force and valve acceleration vs. frequency and valve lift; ; A – for valve lift equal 2.4 mm, B – for valve lift equal 2.4, 4, 5.6 mm

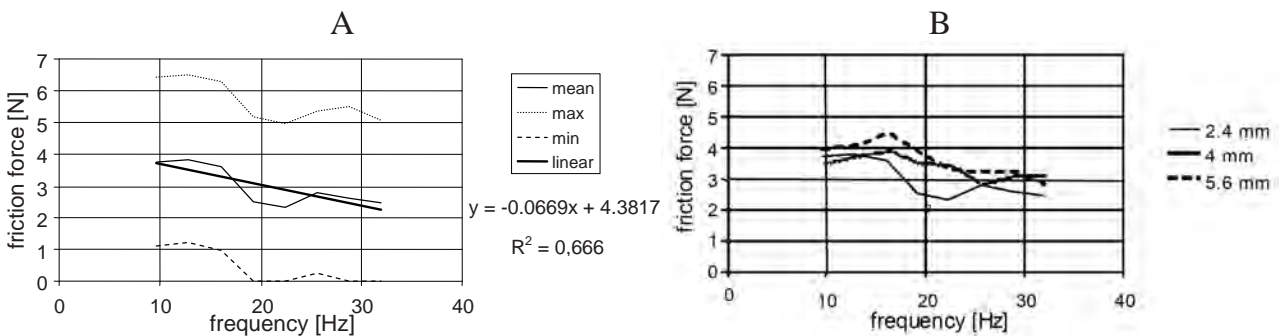

Fig. 12. Friction force between valve stem and valve guide vs. frequency and valve lift; A – for valve lift equal 2.4 mm, B – for valve lift equal 2.4, 4, 5.6 mm

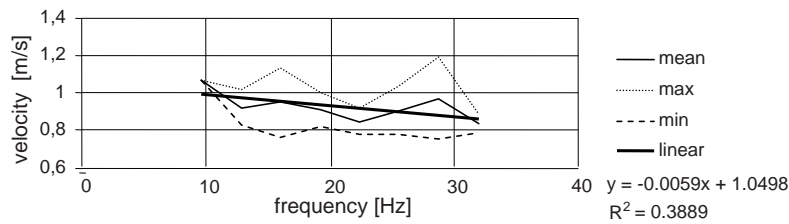

Fig. 13. Mean valve velocity during opening valve vs. frequency and valve lift

5. Conclusion

1. The increase of frequency has resulted in small changes for values of the lift.
2. The increase of frequency has resulted in the increase of changes for values of the valve acceleration, up to 400 m/s^2 , during valve impact into its seat insert. The increase of valve lift has resulted in the increase of the valve acceleration.
3. The greatest values of impact force and acceleration have been observed for the high values of frequency of valve drive. The impact force has increased with increase of valve lift.
4. The ratio of impact force and valve acceleration has changed in thin bands.
5. The friction force has decreased slightly with frequency increase and has decreased with valve lift increase.
6. The sound level has increased with the frequency increase and has been almost independent upon valve lift.

Acknowledgement

The financial support of Ministry of Science and Higher Education by the grant No. NN502394535 is greatly appreciated

References

- [1] Boie, C., Kemper, H., Kather, L., Corde, G., *Method for Controlling a Electromagnetic Actuator for Achieving a Gas Exchange Valve On a Reciprocating Internal Combustion Engine*, US Patent 6340008, 2000.
- [2] Haskara, I., Mianzo, L., Kokotovic, V., *Method of Controlling an Electromagnetic Valve Actuator*, US Patent 6644253, 2001.
- [3] Ma, J., Schock, H., Carlson, U., Høglund, A., Hedman, M., *Analysis and Modeling of an Electronically Controlled Pneumatic Hydraulic Valve for Automotive Engine*, SAE 2006-01-0042.
- [4] Schneider, L., *Electromagnetic Valve Actuator with Mechanical End Position Clamp or Latch*, US Patent 6267351, 2001.
- [5] Sturman, O., *Hydraulic Actuator for an Internal Combustion Engine*, US Patent 5638781, 1994.
- [6] Sun, Z., Cleary, D., *Dynamics and Control of an Electro-Hydraulic Fully Flexible Valve Actuation System*, Proceedings of American Control Conference, Denver, Colorado, June, 2003.
- [7] Theobald, M., Lequesns, B., Henry, R., *Control of Engine Load via Electromagnetic Valve Actuators*, SAE 940816, 1994.
- [8] Wright, G., Schecter, N., Levin, M., *Integrated Hydraulic System for Electrohydraulic Valvetrain and Hydraulically Assisted Turbocharger*, US Patent 5375419, 1994.
- [9] Zbierski, K., *Bezkrzywkowy magnetoelektryczny rozrząd czterosuwowego silnika spalinowego*, Monografia, Wydawnictwo Politechniki Łódzkiej, Łódź 2007.