

SIMULATION OF WORK OF AN ENGINE WORKING WITH COMBUSTION INITIATION FROM IGNITION DOSE OF FUEL

Bronisław Sendyka, Władysław Mitianiec, Marcin Noga

Cracow University of Technology
Institute of Automobiles and Internal Combustion Engines
Jana Pawła II Av. 37, 31-864 Krakow, Poland
tel.: +48 12 6283688, fax: +48 12 6283690
e-mail: bsendyka@pk.edu.pl, wmitanie@pk.edu.pl, noga@pk.edu.pl

Abstract

The paper presents analysis of fuelling and of the course of combustion process for a two-cycle engine. The main idea of the engine according to patent solution of Prof. B. Sendyka consists in the fact that engine work begins from spark ignition, whereas, at higher load and higher temperature in the cooling system there occurs switching off spark ignition and transition to ignition from an ignition dose injected directly into the combustion chamber. Such an engine possesses two injection systems: one system of multi-point injection which forms homogenous mixture, whereas, the other system of direct injection is used for ignition dose injection only. After injection of the ignition dose of a very small mass combustion is initiated on the basis of formation of auto-ignition centres so as it takes place during knock combustion. Auto-ignition centres initiate combustion of the basic charge. Simulation was carried out in order to perform analysis occurring phenomena of fuel feeding and combustion. Works on it started from elaboration of a computational grid of the engine and subsequently analysis of indicated diagrams of engine work with injection of ignition dose was performed. Analysis was also performed of temperature traces and of traces of charge mass change in the cylinder as well as of participation of the mass of basic fuel dose in the cylinder in function of the crank angle. Moreover visualization of effects of the process of mixture formation and combustion was performed and presented in form of illustrations of charge temperature distribution, fraction of fuel ignition and basic dose vapours in cross-sections of the combustion chamber.

Keywords: modelling, simulation, combustion engine, HCCL, two stage injection system

1. Introduction

Works on a two-cycle engine were undertaken in the Chair of Internal Combustion Engines at the Cracow University of Technology. The principle of this solution consists in it that this is an engine of spark-auto ignition, but still it is an engine fuelled with petrol. Starting of the engine occurs at spark ignition, fuelling proceeds by a multi-point injection system. At increased load and temperature of the engine switching off of spark ignition takes place, and injection of ignition dose directly into the combustion chamber starts. The aim of the ignition dose is only to initiate the process of the basic charge ignition similarly as it takes place in the case of knock combustion. In order to get more precise determination of the process of fuel feeding and combustion simulation of the phenomena occurring in this type of engine was performed. Apart from the carried out simulation such an engine was also the object of test bed investigations but this problem lies in the domain of other publications.

2. Simulation analysis

The paper aimed at carrying out simulation studies and visualisation of the combustion process of the engine being the object of investigations during work on combustion initiated by ignition dose of fuel. Numerical analysis was carried out by use of the KIVA-3V software working in 64-bit Linux environment. The works aimed at revealing differences in the process of combustion and engine performance, first of all, of pressure change in cylinder at change of the combustion

system. The ignition dose was defined as 5% of the total mass of the fuel supplied to the engine the rest was the fuel injected into the intake manifold of the engine. Direct injection of fuel took place in some tens crank angle degrees before TDC.

3. Range of simulations

The range of simulative works carried out for the needs of this paper comprised:
Elaboration of computational grid of the engine model:

1. modification of source code of KIVA-3V by introduction of two injection systems. The KIVA-3V software as a standard considers only one fuel injection source,
2. introduction into the programme of procedures calculating heat of the combustion process of the fuel dose delivered to the intake channel and directly into the cylinder and rate of heat release in each of them (modification of the source code) by introduction of thermodynamic data which depend on temperature,
3. establishing of the basic dose for fuel injected into the intake channel and of the ignition dose,
4. carrying out numerical simulation for engine working with combustion initiation from ignition dose of fuel,
5. elaboration of diagrams of traces of thermodynamic parameters of the engine basing upon numerical calculation results,
6. visualisation of combustion process and formation of chemical components of exhaust gases.

4. Object of simulations

One of cylinders of the engine working at rotational speed 2000 RPM with combustion initiated from auto-ignition of directly injected dose of fuel was subject to studies.

The angle of intake valve opening at 4° CA before TDC and closing at 46° CA after BDC was adopted for calculations.

5. Computational grid of the engine

The computational grid of the engine Toyota 2SZ-FE was constructed by use of pre-processor of the KIVA-3V software. The grid is not uniformly concentrated and contains 35 horizontal layers in the cylinder volume. Fig. 1 shows the general view of the grid during intake to the cylinder at 66° CA after TDC. The grid is deliberately concentrated in the TDC region since in consequence of piston displacement the number of computational layers changes too and the shape of cylinder grid is not identical.

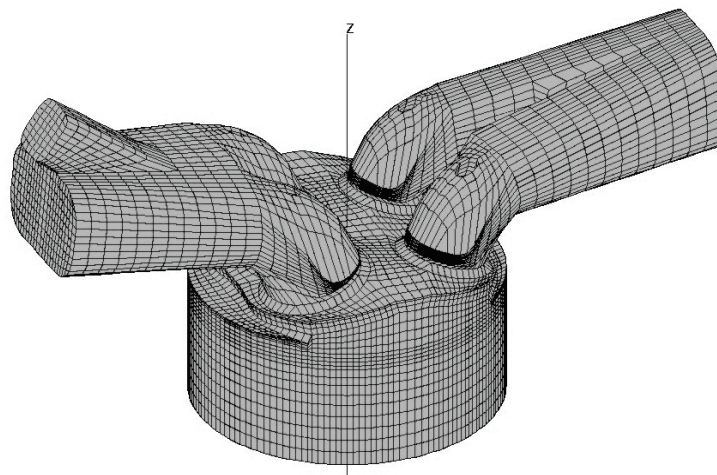

Fig. 1. Computational grid of the engine 2SZ-FE

7. Initial and boundary data

List of initial and boundary data applied in simulations is presented in Tab. 1.

Tab.1. List of initial and boundary data used in simulations

| No. | Parameter | Value | Unit |
|-----|---|-----------------|----------------|
| 1. | Fuel mass dosed to the intake manifold | 0.02085 | g |
| 2. | Mass of the ignition dose of fuel | 0.001125 | g |
| 3. | Engine rotational speed | 2000 | RPM |
| 4. | Angle of start of fuel injection into the intake manifold | 360 | °CA before TDC |
| 5. | Angle of start of ignition-dose injection | 38 | °CA before TDC |
| 6. | Absolute pressure in the exhaust port | 0.1 | MPa |
| 7. | Absolute Pressure in the intake port | 0.13 | MPa |
| 8. | Position of injector with respect to cylinder Z-axis | 68 | ° |
| 9. | Model of turbulence | $k-\varepsilon$ | - |
| 10. | Number of chemical compounds | 12 | - |

8. Results of simulation of engine work with combustion initiated from an ignition dose

Procedure of preparation of the computational grid of engine required series of operations during development of pre-processor. Finally only the cylinder itself was described dimensionally as $X \times Y \times Z = 38 \times 34 \times 36$ computational cells. A number of preliminary simulations preceded the proper simulation process in order to establish correctness of the computations. The programme KIVA-3V permits to present a series of thermodynamic parameters and mass fractions of chemical compounds in the cylinder, in the intake and exhaust system. The actual computational process was performed for the combustion system with injection of ignition dose. Fig. 2 shows the pressure – crank angle indicator diagram of engine working with combustion initiated by injection of ignition dose at 2000 RPM.

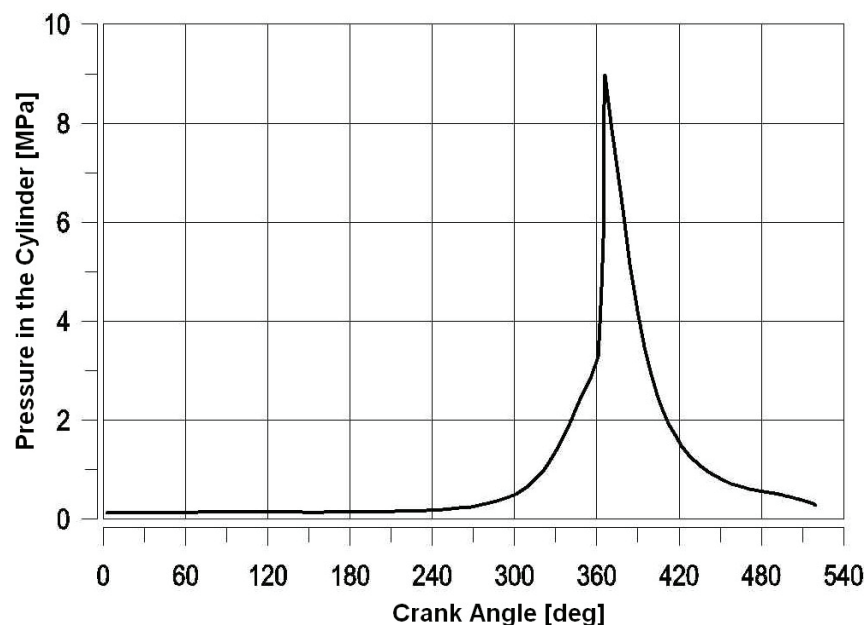

Fig. 2. Pressure – crank angle indicator diagram of engine working with injection of ignition dose at 2000 RPM

A pressure – volume indicator diagram based on pressure trace from Fig. 2 was presented in Fig. 3

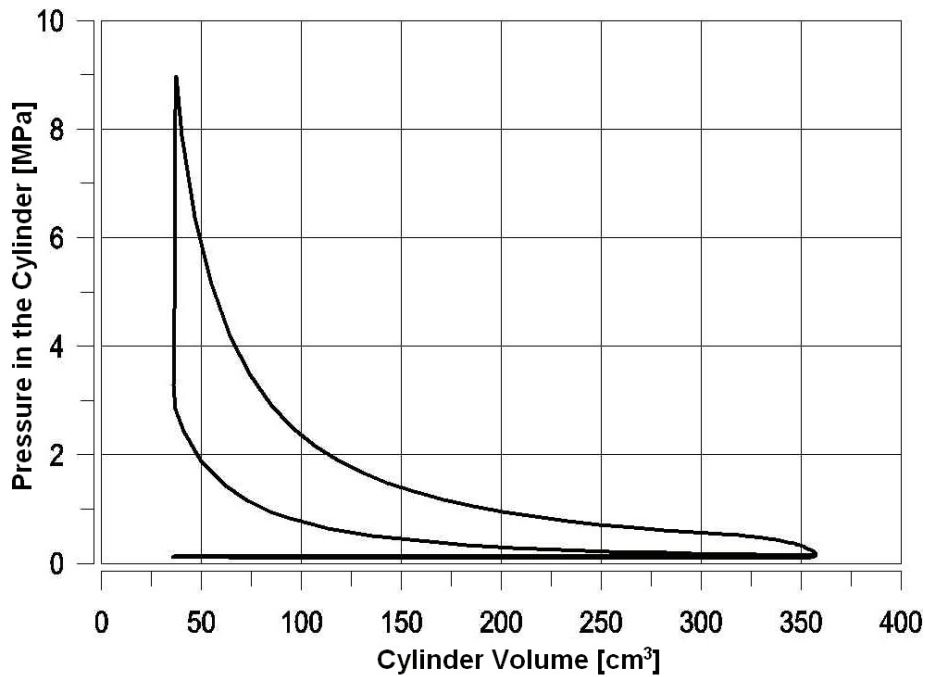

Fig. 3. Pressure – volume indicator diagram of engine working with injection of ignition dose at 2000 RPM

Analysis of the above presented diagrams of pressure in the cylinders indicated at occurrence of a process of heat release close to the theoretical Otto cycle. This conclusion finds confirmation in traces of average and maximal temperature in the cylinder presented in Fig. 4.

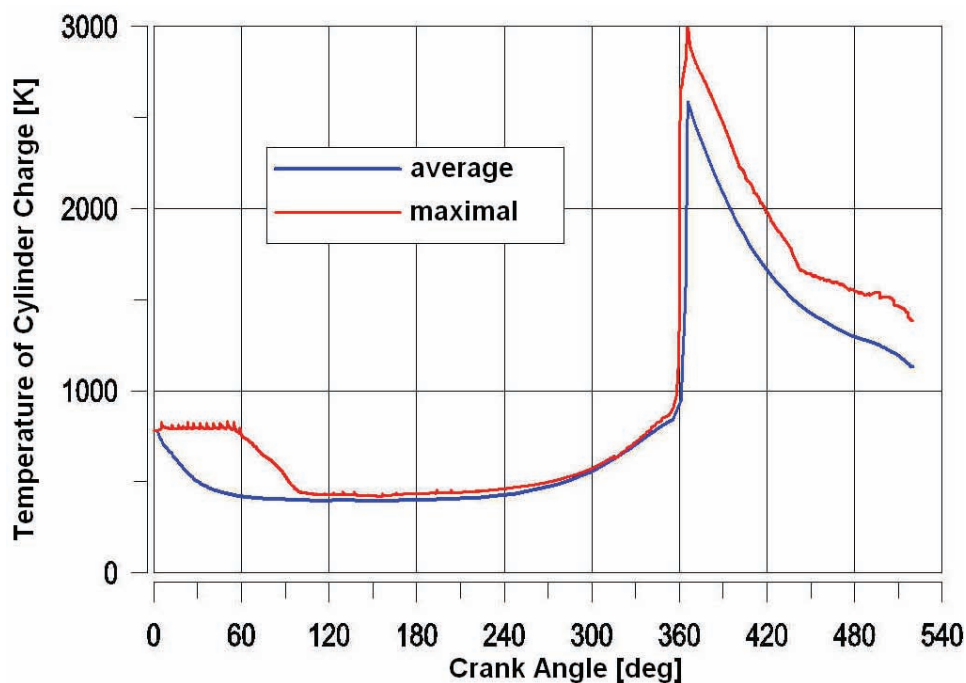

Fig. 4. Average and maximal temperature in the cylinder at combustion initiated from ignition dose

Increment both of the average and maximal temperature in the cylinder as effect of combustion process proceeds rapidly as a rule at constant volume. Maximal temperature in the cylinder reaches the value about 3000 K.

Figure 5 presents the change of cylinder charge mass in function of crank angle during engine work with combustion initiation from ignition dose.

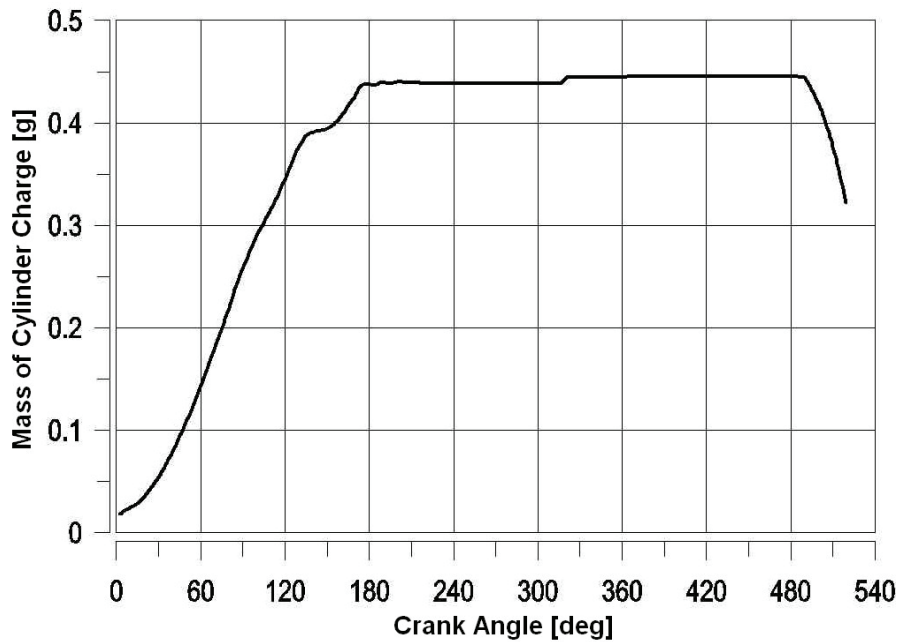

Fig. 5. Change of charge mass in the cylinder of the engine in function of crank angle

A noticeable increase in charge mass in the cylinder around 340° CA results from the process of ignition-dose injection. In Fig. 6 the change of mass fraction of evaporated basic dose of fuel in the cylinder was illustrated in function of the crank angle.

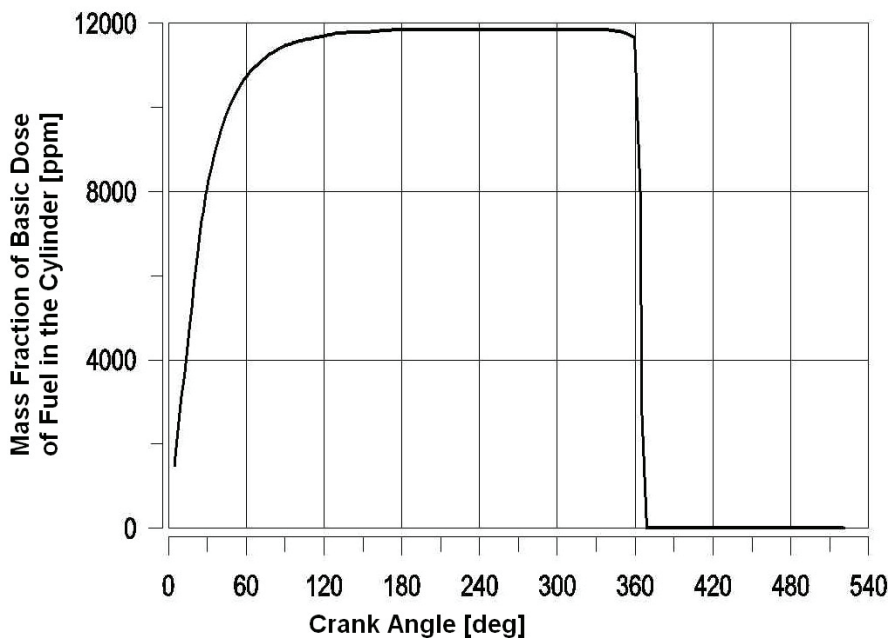

Fig. 6. Change of mass fraction of basic dose of fuel vapours in the cylinder charge in function of crank angle

The rapid drop of mass fraction of the evaporated fuel in the cylinder charge from the maximal value to zero just after TDC (360° CA) also confirms the quick process of combustion. Fig. 7 presents traces of changes of total mass of the ignition-dose as well as mass divided into the liquid and gaseous phase.

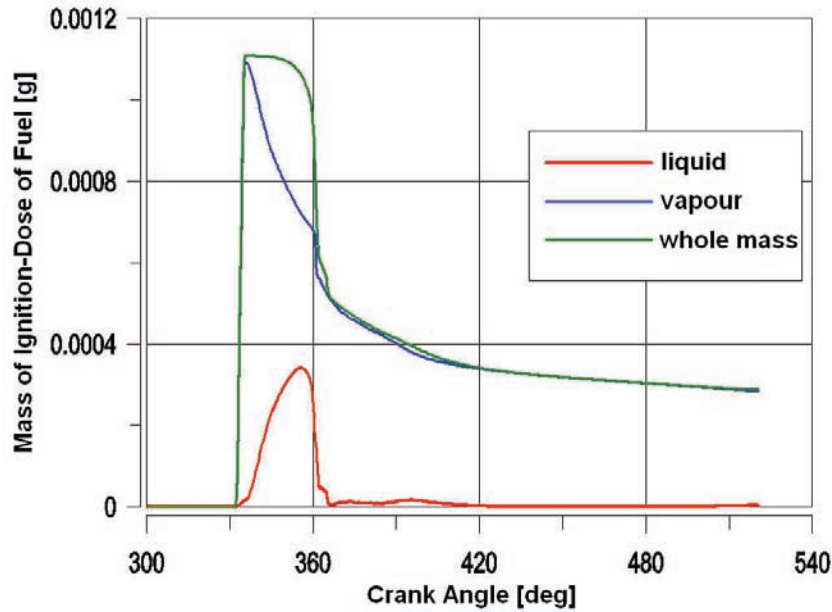

Fig.7. Mass of ignition dose of fuel in the cylinder

Uncompleted combustion of the ignition dose is noticeable, this being result of application of the direct injection system working at a relatively low operation pressure.

9. Visualisation of effects of mixture formation and combustion process in the engine

The KIVA-3V software permits presentation of distribution of a number of thermodynamic parameters and mass fractions of chemical components in the cylinder charge as well as in the intake and exhaust system.

Figure 8 presents distribution of charge temperature in cross-section of the working space of the cylinder at piston position 10° CA before TDC.

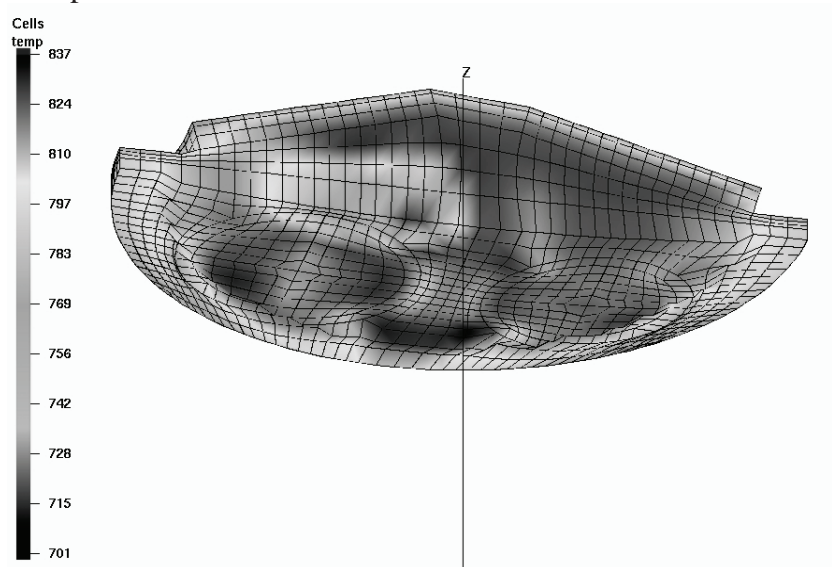

Fig. 8. Distribution of temperature in the cylinder at piston position 10° CA before TDC

In the central part of the cylinder a zone of lowered temperature is noticeable. This phenomenon is the effect of the process of injection and evaporation of the ignition dose of fuel. Distribution of charge temperature in the cylinder at position 4° CA is presented in Fig. 9.

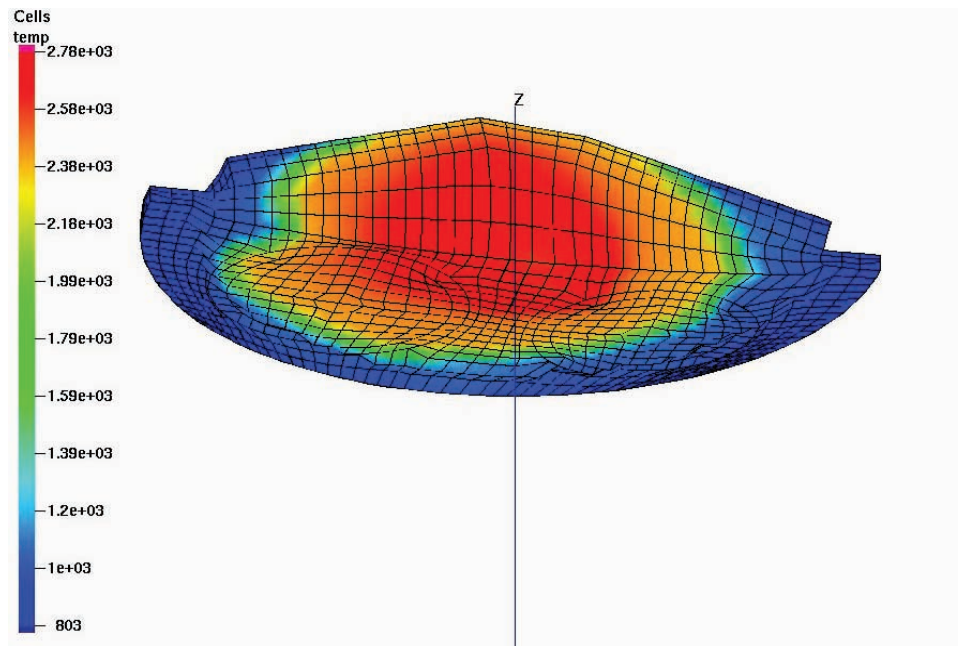

Fig. 9. Distribution of temperature in the cylinder at piston position 4° CA after TDC

It is clearly visible that the zone of the charge enveloped by combustion covers regularly the major part of the combustion chamber.

Figure 10 presents distribution of vapours of the basic dose of fuel in longitudinal section of the cylinder for piston position 25° CA before TDC.

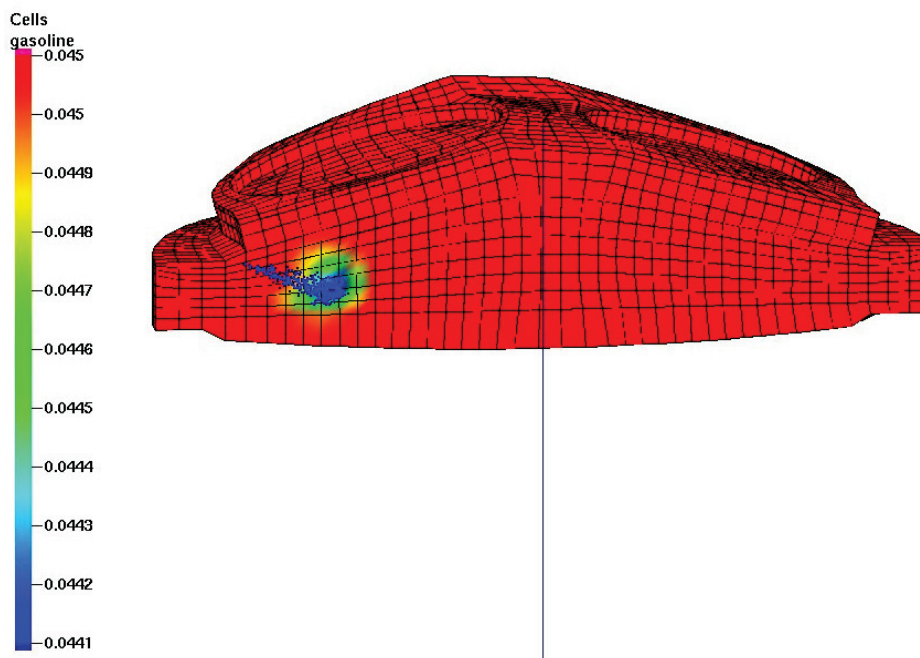

Fig. 10. Mass fraction of evaporated basic dose of fuel in the cylinder at piston position 25° CA before TDC

In the left part of the picture one can see an area in which vapours of basic fuel dose were forced out by a stream of ignition dose injected into the cylinder. Fig. 11 shows distribution of mass fraction of vapours of the basic dose of fuel in the cylinder charge at piston position 9° CA after TDC.

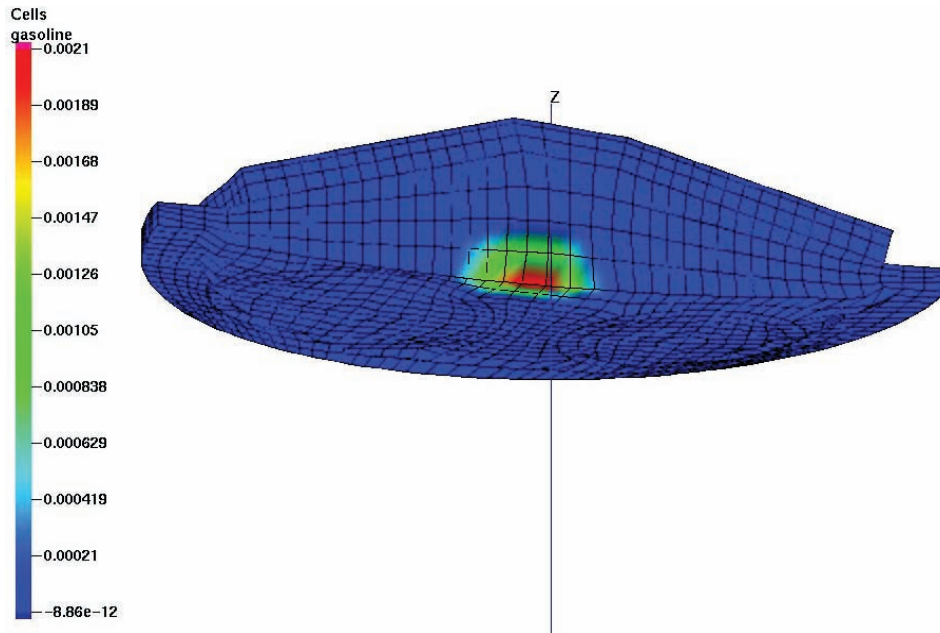

Fig. 11. Mass fraction of vapours of the basic dose of fuel in the cylinder charge at piston position 9° CA after TDC

At the piston position 9° CA after TDC the zone with unburned basic dose of fuel concentrates only in the central part of the combustion chamber. Distribution of the mass of the ignition dose of fuel in the cross-section of the combustion chamber at piston position 1° CA before TDC is presented in Fig. 12.

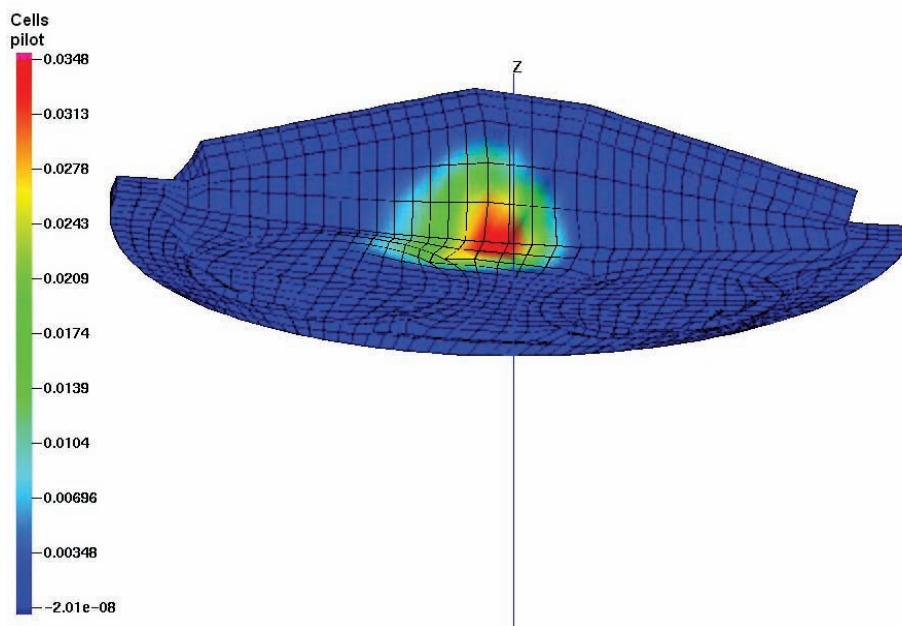

Fig. 12. Mass fraction of vapours of ignition-dose of fuel at piston position 1° CA before TDC

The above given illustration shows the evaporated ignition-dose of fuel visible in the central zone of the combustion chamber. This is the moment just preceding the start of the combustion process (TDC). In the subsequent illustration in Fig. 13 distribution of the thickness of the film of ignition dose of fuel is presented.

On the piston crown there is noticeable an area in which a thin (about $5 - 9 \mu\text{m}$) layer of not evaporated and unburned ignition fuel is deposited being to a certain extent – the source of hydrocarbon emission.

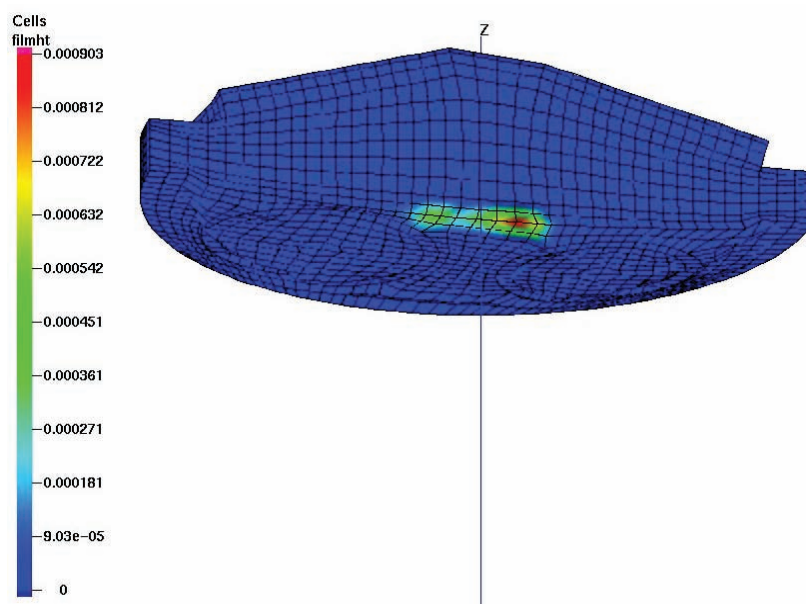

Fig. 13. Thickness (cm) of the film of the ignition-dose of fuel at piston position 23° CA after TDC

10. Conclusions

The carried out simulation of the working cycle of the engine revealed the possibility of ignition of an air-fuel mixture by use of a pilot dose of fuel injected directly into the cylinder. Analysis of results of simulation of the combustion process showed following regularities:

1. at assumed situation of the injector of the ignition dose and fixed mixture composition ignition of the charge takes place at the moment when piston reaches TDC,
2. at an assumed kinetic model of fuel combustion the process of combustion pressure in the initial phase is characterized by very high charge combustion velocity,
3. maximal combustion temperature reaches the value of almost 3000K,
4. auto-ignition of the mixture occurs on the border of the stream of the injected pilot-dose
5. the applied system of injection of the pilot dose causes formation of a fuel film of minute thickness of about 5-9 μm which remains almost still the end of the combustion process,
6. the combustion process is very short and for the range 10 – 90% of the burned fuel it equals only 15° CA.

Acknowledgements

The scientific work financed from financial means for science and education in the years 2009 -2011 as a research project No. N N509 405036.

References

- [1] Abraham, J., Magi, V., *GMV, General Mesh Viewer*, Los Alamos National Laboratory LA-UR-95-2986, Los Alamos 1995.
- [2] Amdsen, A., *KIVA-3V, Release 2, Improvements to KIVA- 3V*, LA-13608-MS, Los Alamos National Laboratory, Los Alamos 1999.
- [3] Jankowski, A., *Studium wpływu ciśnienia, prędkości i rodzaju strugi gazów na przebieg procesu spalania*, Wydawnictwo Instytutu Technicznego Wojsk Lotniczych, Warszawa 2010.
- [4] Kowalewicz, A., *Wybrane zagadnienia samochodowych silników spalinowych*, Wydanie 2, poprawione i uzupełnione, Wydawnictwo Politechniki Radomskiej, Radom 2002.