

# MONITORING OF COMBUSTION PROCESSES IN INDUSTRIAL BURNERS USING ELECTRICAL CAPACITANCE TOMOGRAPHY

Zbigniew Gut, Piotr Wolanski, Pawel Oleszczak

Institute of Heat Engineering, Warsaw University of Technology  
Nowowiejska Street 21/25, 00-665 Warsaw, Poland  
tel.: +48 22 2345287, fax: +48 22 8250565  
e-mail: zgut@itc.pw.edu.pl

## Abstract

The development of diagnostic methods suitable for the monitoring of practical flames is an important objective, which is receiving a growing attention and significant research efforts. This is motivated by the need to achieve a more precise description of the process and, ultimately, implement efficient and reliable control and optimization methods as a key step towards the development of more efficient, flexible, reliable and clean combustion systems. Many interesting attempts have been proposed, involving very different approaches in the use of various instruments and sensors. One of parameter difficult to control is distribution of reaction zone. Presently, such system which allows monitoring combustion process of industrial burners does not exist. Measurements of temperature or control of exist flame by using ionization probe provide only partial information about performance of combustion process. For that reason, new diagnostic methods should be developed. Many and interesting attempts have been proposed but one of interesting solution will be development of combustion process diagnostic methods by means of the Electrical Capacitance Tomography (ECT). Obtained results show that it will be a very good tool for research proposes, especially in development of a new combustion chamber operated at very high pressure, where installation of optical windows is very difficult and many time not possible.

**Keywords:** combustion, industrial burner, diagnostic, tomography

## 1. Introduction

Electrical Capacitance Tomography (ECT) is used to obtain information about the spatial distribution of a mixture of dielectric materials inside a vessel, by measuring the electrical capacitances between sets of electrodes placed around its periphery and converting them into an image showing the distribution of permittivity.

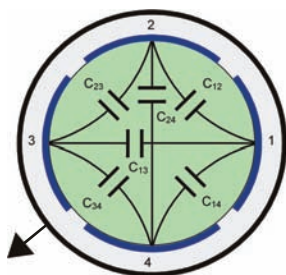

$$C_{ij} = \varepsilon \frac{A}{d};$$

$C_{ij}$  – capacitance between pair of electrode  $i$  and  $j$ ;  
 $A$  – the area of each plane electrode;  
 $d$  – the distance between the electrodes;  
 $\varepsilon$  – the dielectric constant or relative permittivity of the insulator used.

Fig 1. Schematic of the sensor for ECT system.

ECT can be used with non-conducting materials such as plastics, hydrocarbons, sand or glass and is often used with mixtures of two different dielectric materials [1] [2] [3]. ECT has several advantages, such as low cost, fast response (>100 frames per second), no radiation, non-intrusive and non-invasive, and robust in hostile environments with high temperature and high pressure, over other tomography modalities. Experimental studies have been carried out showing that this method can be applied to visualization of combustion processes [4]

[5] [6]. When fuel is burnt, a large number of charged particles, ions and free electrons are generated [7]. These particles will modify both the permittivity and conductivity of the reaction zone. So, the ECT is based on measurements of a variation of electrical properties of the flame, such as electrical permittivity and conductivity of the reaction zone and signal level depends on the concentrations of various kinds of charged particles present during the combustions.

A typical ECT system can be categorized into three parts: sensor, data acquisition unit and a computer for an image reconstruction (Fig. 2.).

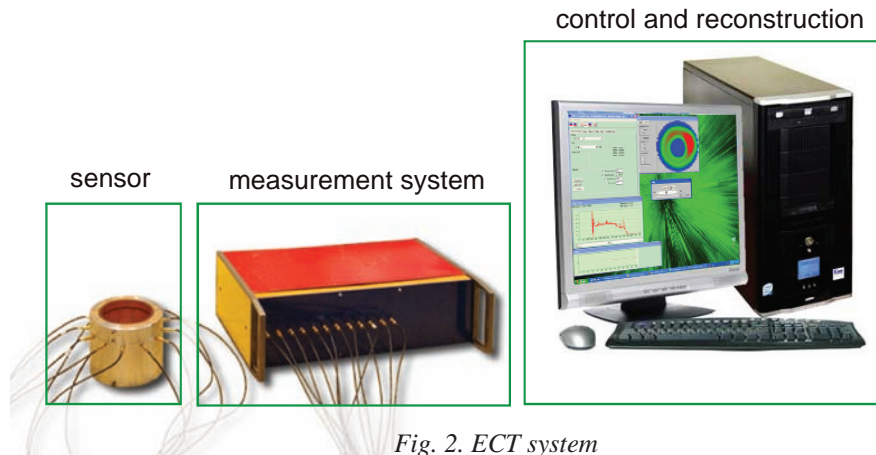

Fig. 2. ECT system

The sensor consists of a set of electrodes symmetrically mounted outside measurement space. The sensing electronics measure the capacitances for all possible electrode combinations. The computer system has two major functions. Firstly it controls the measurement operations performed by the sensing electronics, and secondly it uses the measurement data to reconstruct tomographic images. The method normally used to obtain ECT images from capacitance measurements is the Linear Back Projection (LBP) algorithm, which produces relatively low-accuracy images. For improving the accuracy of LBP images a simple iterative image computation method – ILBP (Iterative Linear Back Projection) is used.

## 2. Experimental research

In order to show the system possibilities open-ended steel chamber was used which was fitted with twelve electrodes, as shown in Fig. 3. The cylinder is 100 [mm] in diameter and 150 [mm] high. The electrodes are 100 [mm] long and are located centrally along the cylinder. The electrodes are made from brass, which is electrically insulated from the cylinder wall with a thin sheet of mica. Additionally, rotating ring of four Bunsen burners were installed.

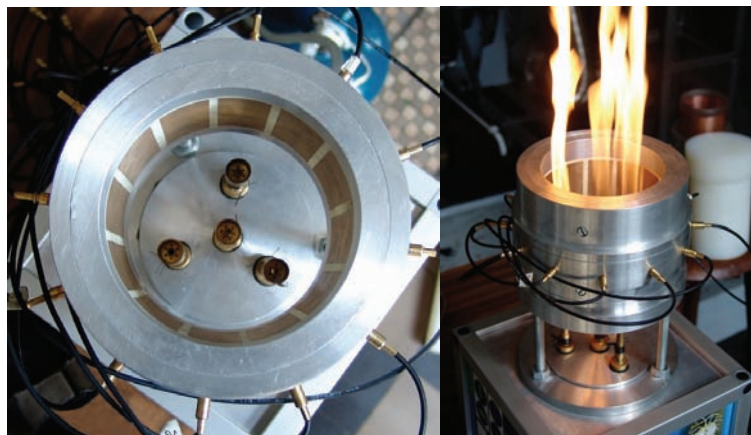

Fig. 3. View of experimental chamber

The first test consisted of inserting the flame from a Bunsen burner inside the can. The flames were moved around inside the chamber and the reconstructed image displayed in pseudo-colour on a monitor.

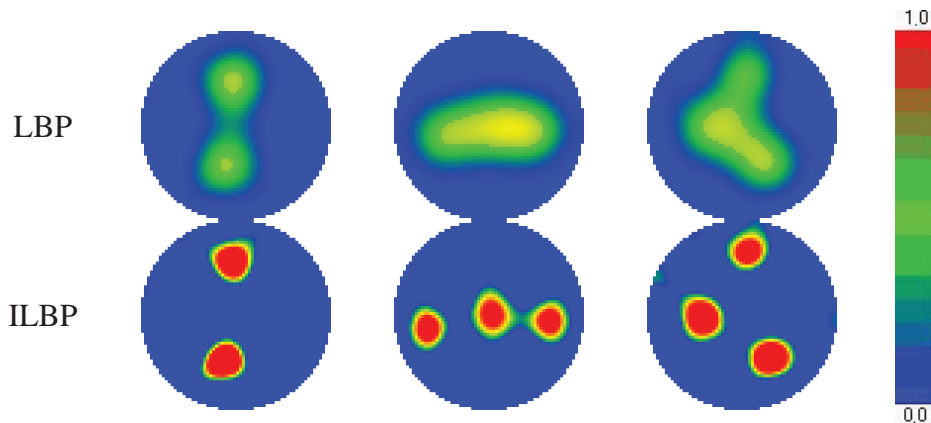

Fig. 4. The reconstructed images of two and three burners using LBP and ILBP methods

The images tracked the flame movements in real-time in a satisfactory manner. From the description of the LBP method, it is clear that images produced by this method will always be approximate. The method spreads the true image over the whole of the sensor area and consequently produces very blurred images. In this case we don't know how much burners were used but helpful was using simple iterative algorithm. Now, we can correctly define position and number of flames.

In the next stage of the research was used a gas burner a variable power 12.5 - 50 [kW] - Weishaupt WG10N. Burners of this type are equipped with digital burner management which is use to setting, controlling and monitoring of all burner functions.

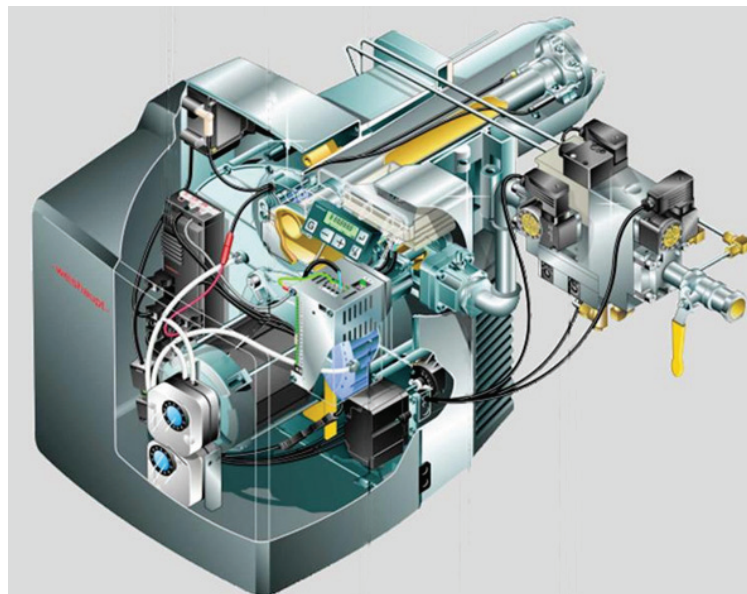

Fig. 5. View of industrial burner - WG10N

In real operating conditions, the burner is mounted in a heat exchanger or boiler. However, for research purposes was designed and built a special clamping system of burners. In this way, the burner was equipped with a steel plate and mounting system to the platform. Additionally, for the burner made a special sleeve that forms the structural base for mounting the electrodes. Due to the high temperatures occurring in the space between the electrodes, a difficult problem to solve was finding the appropriate cables connecting the electrodes of the measuring system. The ideal solution was to use a special heat-resistant silicone braided wire metal whose resistance temperature reaches 400°C.

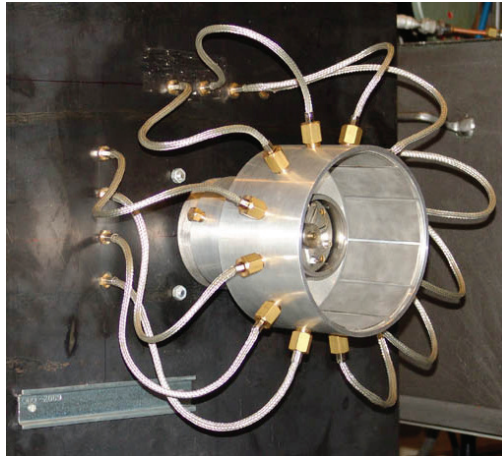

Fig. 6. View experimental stand

To determine possible system Electrical Capacitance Tomography for a few selected power burner reconstruction of the combustion process was carried out.

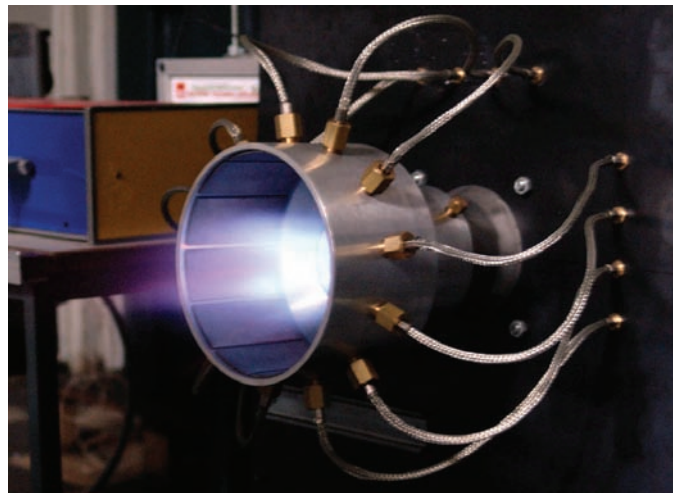

Fig. 7. Combustion process of industrial burner

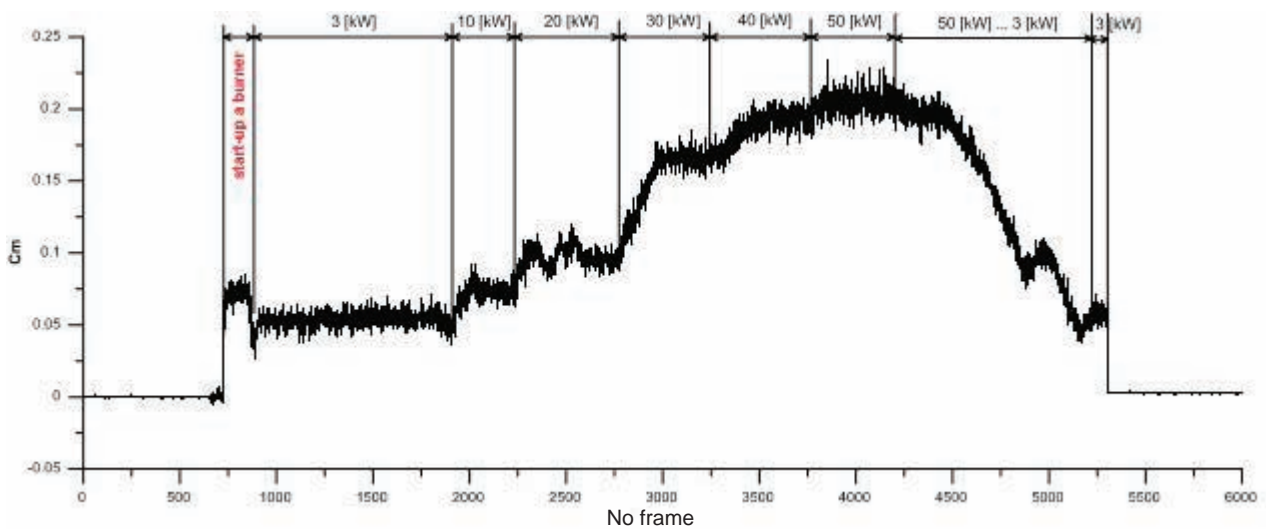

Fig. 8. Variations of normalized capacitance for different flame intensity

The tomography system registered 25 measurement frames per second; each frame consisted of 66 measurements. On the basis of measurement data from individual pairs of electrodes were carried out reconstruction of the combustion process.

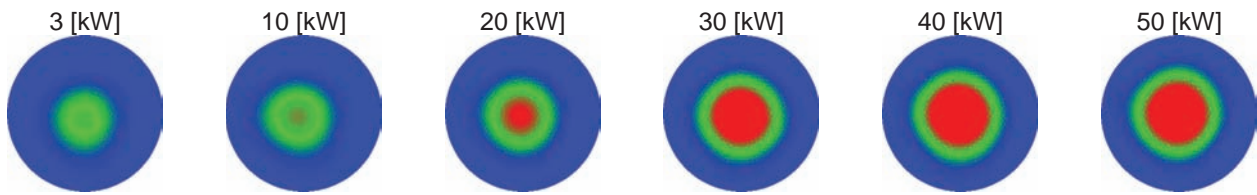

Fig.9. Image reconstruction for different power of burner

The results above show that the position and size of the combustion zone can be identified by using the ECT system. The distribution of the flame in the electrodes sensor can be monitored online. As a conclusion, a hardware system and the software programming that able to provide real time cross-sectional image have been developed.

### 3. Summary

Research which has been carried out at the Institute Heat Engineering was focused on possibility of the 2-D reconstruction of combustion process by ECT method. Researches show that it has the major advantage over optical visualization systems since it does not require optical access and use passive, non-invasive electrodes. The main disadvantage of this technique is its lower spatial resolution as compare to the other tomographic imaging techniques or optical systems, but despite this, it will be a very good tool for research and diagnostic of combustion systems. It can be used during development of a new industrial burner operated at very high pressure, where installation of optical windows is very difficult and many times not possible. The ECT can also be used for on line diagnostic and will ensure the safe burner operation. It will also open a new way for active control of combustion processes in industrial applications.

### 4. Acknowledgements

This work was partially supported by the following grants: from Polish National Center of Research and Development, grant: NR06000204, „Electrical Capacitance Tomography system for the visualization of flames” and grant provided by Former Polish Pilots in England entitled: “The development of computed tomography system for safety inspection of aircraft engines”.

### References

- [1] Plaskowski, A., Beck. M. S., Byars, M, Dykowski, T., He, R., Wang, S. J., Waterfall, R. C. and Yang, W. Q., *Industrial application of electrical capacitance Tomography*, *Pomiary Automatyka Kontrola* 5 pp. 113-115, 1996.
- [2] Yang, W. Q., Stott, A. L., Beck. M. S. and Xie, C. G., *Development of capacitance tomographic imaging systems for oil pipeline measurements*, *Review of Scientific Instruments* 66 (8) pp. 4326-4332, 1995.
- [3] Huang, S. M., Plaskowski, A., Xie, C. G. and Beck. M. S., *Tomographics imaging of two-component flow using capacitance sensors*, *Meas. Sci. Technol.* No. 22 pp.173-177, 1989.
- [4] Waterfall, R. C., He, R., White, N. B. and Beck, C. M., *Combustion imaging form electrical impedance measurements* *Meas. Sci. Technol.* No. 7 pp.369-374, 1996.
- [5] Gut, Z., Wolanski, P., He, R., Waterfall, R. C., *Application of Electrical Tomography to Combustion Studies*, 16th International Colloquium on the Dynamics of Explosions and Reactive Systems, Krakow Poland, 1997.
- [6] Gut, Z., Wolanski, P., *Diagnostic of combustion process inside the turbojet combustion chamber by Electrical Capacitance Tomography*, 19th ISABE Conference, Montreal, Kanada, 2009.
- [7] Yang, W. Q. and Peng L., *Image reconstruction algorithms for electrical capacitance tomography*, *Meas. Sci. Technol.* 14 R1–13, 2003.