

Production, quality control and initial imaging studies of [^{82m}Rb]RbCl for PET studies

Pejman Rowshanfarzad,
Amir Reza Jalilian,
Mohsen Kiyomarsi,
Mahsheed Sabet,
Ali Reza Karimian,
Sedigheh Moradkhani,
Mohammad Mirzaii

Abstract Rubidium-82m was prepared via 15.4 MeV proton irradiation of a krypton-82 gaseous target (30% enrichment). Washing the target chamber with hot water yielded a Rb-82m containing solution, which was further purified using short column chromatography in order to remove organic/inorganic impurities. The flowthrough was formulated in normal saline for injection. Radionuclide, radiochemical and chemical purity tests were performed prior to administration to rats for imaging (radiochemical yield: 95–97%, radiochemical purity > 97%). Preliminary dual-head coincidence studies were performed to determine the distribution of [^{82m}Rb]Rb in normal rats. For biodistribution studies, Rb-81 was injected to rats and tracer accumulation in heart, GI and bladder was determined after sacrifice in time intervals. A yield of 1.3 GBq at EOB, 235.7 MBq/ μAh was obtained.

Key words rubidium-82m • quality control • animal study • cyclotron

P. Rowshanfarzad, A. R. Jalilian✉, M. Kiyomarsi,
A. R. Karimian, S. Moradkhani, M. Mirzaii
Cyclotron and Nuclear Medicine Department,
Nuclear Research Center for Agriculture
and Medicine (NRCAM),
Atomic Energy Organization of Iran (AEOI),
Moazzen Blvd., Rajae shahr, Karaj, Iran,
P. O. Box 31485-498,
Tel.: +98 261 4436397, Fax: +98 261 4464053,
E-mail: ajalilian@nrcam.org

M. Sabet
SSDL and Health Physics Department,
Nuclear Research Center for Agriculture
and Medicine (NRCAM),
Atomic Energy Organization of Iran (AEOI),
Moazzen Blvd., Rajae shahr, Karaj, Iran,
P. O. Box 31485-498

Received: 28 April 2006
Accepted: 31 August 2006

Introduction

Rubidium radionuclides have been used in nuclear cardiology. Rubidium-81 has been used in diagnosis of ischaemic heart disease [13], coronary stenosis [14] and noninvasive myocardial imaging [4].

Since 1980, Lambrecht and colleagues showed that Rb-82m can be a useful radionuclide for cardiac imaging, while the other rubidium radionuclide [8], i.e. Rb-82, used as a radiotracer for nuclear cardiology [10], has a very short half-life (1.27 min) [11], and its use has not been reported widely.

Rb-82m can be a good substitute for cardio-PET clinical studies due to its suitable physical properties (Table 1). This radionuclide decays to the stable krypton-82 isotope and is a potassium analog for the evaluation of Na^+/K^+ ATPase performance in myocardium cells like other Rb isotopes [9]. With respect to the increasing importance of positron emitters in clinical studies, use of PET rubidium nuclides has come to a great importance [12, 16].

Due to our recent works on the production and quality control of some PET radiotracers [5, 6], we were interested in the production, formulation, quality control and administration of Rb-82m solution for future clinical PET applications. In this study, Rb-82m was produced, purified and formulated as a PET radiopharmaceutical. Preliminary imaging studies were

Table 1. Physical characteristics of rubidium radionuclides

Gamma energies [keV]	Maximum β^+ energy	Decay mode [%]	Half-life	Nuclear reaction	Radioisotope
190.38(64.0%) 456.76(3.02%) 446.15(23.2%) 510.31(5.3%) 537.60(2.23%)	2.1 MeV	β^+ (27.2) E.C. (72.8)	4.576 h	$^{82}\text{Kr}(p,2n)^{81}\text{Rb}$	Rb-81
776.517(13%)	3.38 MeV	β^+ (95.5) E.C. (4.5)	1.273 m	$^{82}\text{Kr}(p,n)^{82}\text{Rb}$	Rb-82
776.517(84%) 554(64%) 619(38%) 698.374(26.3%) 1474.88(15.53%) 1044.002(32.00%) 619.106(37.975%) 1317.473(23.7%) 554.348(62.4%) 827.828(21.0%) 1007.59(7.17%)	0.8 MeV	β^+ (26) E.C. (74)	6.472 h	$^{82}\text{Kr}(p,n)^{82m}\text{Rb}$	Rb-82m

carried out using a dual head SPECT system, equipped with a co-incidence camera. Also, due to the production of $^{81}\text{Rb}/^{81m}\text{Kr}$ generator for country use in our Institution [1], biodistribution of radiorubidium was studied in normal rats using Rb-81 radionuclide.

Experimental

Materials

Chemicals were purchased from Merck Chemical Company (Germany). Thin-layer chromatography (TLC) was performed on polymer-backed silica gel (F 1500/LS 254, 20 × 20 cm, TLC Ready Foil, Schleicher & Schuell®, Germany). Radiochromatography was carried out by counting 5 mm slices of polymer-backed silica gel paper using a Canberra™ high purity germanium detector (HPGe, model GC1020-7500SL). Si and C₁₈ Sep-Paks were purchased from Waters Co. All calculations and TLC counting were based on the 511 keV peak. Animal experiments were carried out in compliance with the United Kingdom Biological Council's Guidelines on the Use of Living Animals in Scientific Investigations, 2nd ed.

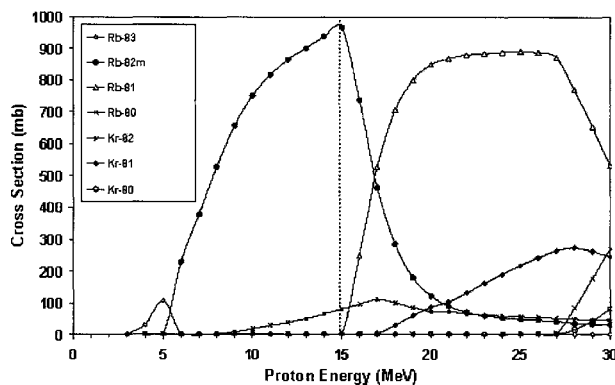
**Fig. 1.** Results of ALICE code for $^{82}\text{Kr}+p$ reactions.

Methods

Targetry and bombardment

Results of excitation functions calculated by ALICE nuclear code [3] for $^{82}\text{Kr}(p,x)$ nuclear reactions showed that 15 MeV protons are best for the production of Rb-82m as a result of the $^{82}\text{Kr}(p,n)^{82m}\text{Rb} \xrightarrow{6.5\text{h}} ^{82}\text{Kr}$ reaction (Fig. 1). A 30% enriched gaseous krypton-82 target of 251 mm thickness was irradiated under pressure of 0.27 MPa at 15.4 MeV proton beam energy in a stainless steel chamber. The target was cooled using 18°C water, while applying a current intensity of 10 μA with an integrated charge of 5.5 μAh (maximum chamber pressure: 0.36 MPa).

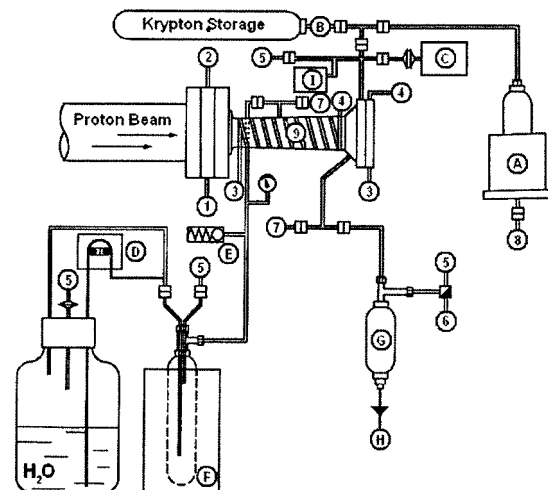
**Fig. 2.** Schematic diagram of the rubidium-82m production system; 1 – air inlet for window cooling; 2 – air outlet; 3 – water inlet for target cooling; 4 – water outlet for target cooling; 5 – atmosphere; 6 – pressurized air; 7 – vacuum line; 8 – liquid nitrogen; 9 – target body; A – main cryogenic trap; B – secondary cryogenic trap; C – vacuum gauge; D – peristaltic pump; E – safety valve; F – steam oven; G – collection vessel; H – transfer tubing; I – pressure gauge for target.

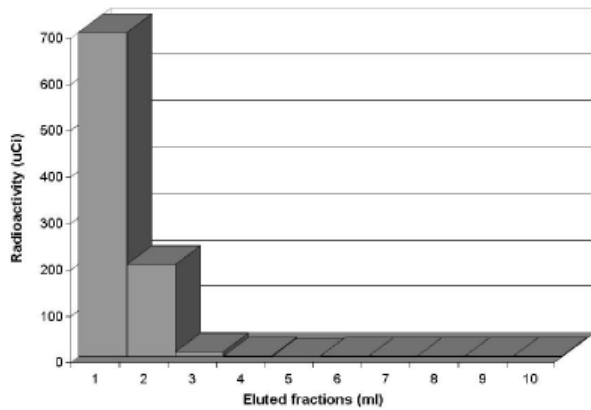

Fig. 3. Elution fractions of Rb⁺ cation through the C₁₈ Sep-Pak column.

After irradiation, the walls were rinsed with Milli-Q® sterile hot water in order to yield rubidium-82m in hydroxide form. Details of the production system are summarized in Fig. 2. The final radioactive solution was passed through a C₁₈ Sep-Pak column in order to remove possible organic impurities (Fig. 3).

Formulation

The product was dried using nitrogen gas flow and 0.5 ml of normal saline was added per 37 MBq activity of ^{82m}Rb for its biocompatibility. Alternatively, the radioactive solution could be injected into a Si Sep-Pak (pretreated with normal saline) followed by N₂ gas purging for one minute. The radioactive fraction was eluted using double distilled water fractions (Fig. 4).

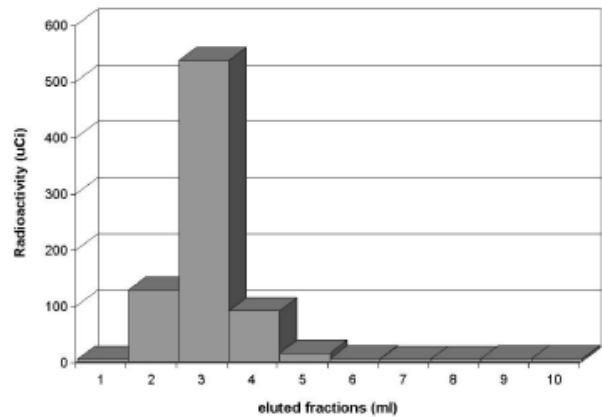

Fig. 4. Elution fractions of Rb⁺ cation through the Si Sep-Pak column.

pH was adjusted between 4–7 by the addition of small amounts of 0.01 N HCl and/or 0.01 N NaOH and the solution was passed through a 0.22 μ filter (Cathivex) and was finally autoclaved.

Quality control

Radionuclide purity. Gamma spectroscopy of the final sample was carried out using an HPGe detector. Based on the presence of Ti and Fe in the window and the irradiated target body, there was a possibility of interfering nuclear reactions with protons, and these possibilities were taken into account for each target material. Some characteristics of the expected impurities are summarized in Tables 2 and 3.

Table 2. Characteristics of radionuclides produced in nuclear reactions of protons on the natural Fe content of the window with a proton beam [5]

Main gamma energies [keV]	Nuclear reaction	Half-life	Radionuclide
1408.4(16.88%) 1316.4(7.09%) 931.3(75%) 477.2(20.2%)	⁵⁴ Fe(p,γ) ⁵⁵ Co	17.53 h	⁵⁵ Co
3253.416(7.93%) 3201.962(3.24%) 2598.459(17.28%) 2034.755(7.88%) 2015.181(3.08%), 1771.351(15.69%) 1238.282(67.6%) 1037.84(13.99%) 846.771(100%)	⁵⁶ Fe(p,n) ⁵⁶ Co ⁵⁷ Fe(p,2n) ⁵⁶ Co	77.26 d	⁵⁶ Co
136.474(10.68%) 122.0614(85.6%) 14.41(9.16%)	⁵⁶ Fe(p,γ) ⁵⁷ Co ⁵⁷ Fe(p,n) ⁵⁷ Co ⁵⁸ Fe(p,2n) ⁵⁷ Co	271.79 d	⁵⁷ Co
810.764(99%)	⁵⁸ Fe(p,n) ⁵⁸ Co ⁵⁷ Fe(p,γ) ⁵⁸ Co	70.86 d	⁵⁸ Co
749.04(0.26%)	⁵⁴ Fe(p,α) ⁵¹ Mn	46.2 m	⁵¹ Mn
834.848(99.976%)	⁵⁷ Fe(p,α) ⁵⁴ Mn	312.3 d	⁵⁴ Mn
2113.123(14.3%) 1810.772(27.2%) 846.7(98.9%) 834.848(99.976%)	⁵⁷ Fe(p,2p) ⁵⁶ Mn	2.5785 h	⁵⁶ Mn

Table 3. Characteristics of radionuclides produced as a result of nuclear reactions of the natural Ti content of the window with a proton beam [7]

	Radionuclide			
	⁴⁸ V	⁴³ Sc	^{44m} Sc	⁴⁷ Sc
Half-life	15.9735 d	3.891 h	58.608 h	3.345 d
Nuclear reaction	⁴⁷ Ti(p,γ) ⁴⁸ V ⁴⁸ Ti(p,n) ⁴⁸ V ⁴⁹ Ti(p,2n) ⁴⁸ V ⁵⁰ Ti(p,3n) ⁴⁸ V	⁴⁶ Ti(p,α) ⁴³ Sc	⁴⁷ Ti(p,α) ^{44m} Sc	⁴⁸ Ti(p,2p) ⁴⁷ Sc
Gamma energies [keV]	1312.096(97.5%) 983.517(99.98%) 944.104(7.76%)	372.76(22%)	271.13(87.8%)	159.369(67.9%)

Chemical purity. Due to the presence of titanium windows in the irradiation chamber and the stainless steel used in the target body, the presence of iron and titanium cations were checked by colorimetric assays. Formation of colored metal complexes were measured using visible spectroscopic assays to determine Ti and Fe cation concentrations.

Radiochemical purity. Radio thin-layer chromatography was performed using normal saline as the mobile phase. The developed Si sheets were counted using an in-house made radiochromatogram scanner equipped with an HPGc detector. The step motor was installed to count 0.4 cm-pieces every 30 seconds through the slot of a shielded chamber. Thus, the radiochemical yields were determined by comparison of the ^{82m}Rb peak and the rest of the paper based on the 511 keV peak (Figs. 5 and 6). Calculations were based on the 190 keV peak.

Biodistribution studies

Animal tests were performed using the Rb-81 radionuclide due to its availability on weekly production of the ⁸¹Rb/^{81m}Kr generator. Distribution of [⁸¹Rb]Rb in tissues were determined in Sprague-Dawley rats. A volume (0.1 ml) of final [⁸¹Rb]Rb solution containing 0.74–1.48 MBq radioactivity (≤ 6 ng Rb in 50 μL) was injected into the dorsal tail vein. The total amount of radioactivity injected into each rat was measured by counting a 1-ml syringe before and after injection in an activity meter with fixed geometry. The animals were

sacrificed by ether asphyxiation at selected times after injection, the tissues were weighed and their specific activities determined as the percentage of injected dose per gram of tissues, using γ-ray scintillation.

Imaging studies

0.1 ml volumes of the final [^{82m}Rb]Rb solution containing 11.1 MBq activity (≤ 6 ng rubidium in 50 μL) were injected into the dorsal tail vein of healthy rats. The total amount of radioactive material injected into each rat was measured by counting a 1-ml syringe before and after injection in an activity meter with fixed geometry. The animals were relaxed by halothane and fixed in a suitable probe. Images were taken 0.5, 1, 1.5, 2, 2.5, 3, 3.5 and 4 h after administration of the radiopharmaceutical in coincidence mode of a Dual-Head SPECT system (SMV, France, Sopha DST-XL). The useful field of view (UFOV) was 540 mm × 400 mm. The spatial resolution in the coincidence mode was 10 mm FWHM at the CFOV, and sensitivity was 20 Kcps/3.7 × 10⁴ Bq/cc. Sixty four projections were acquired for 30 s per view with a 64 × 64 matrix. Each rat was studied for 4 h during which images were taken every 30 min.

Results and discussion

As a result of 15 MeV proton bombardment of ⁸²Kr, 1.3 ± 0.07 GBq activity of ^{82m}Rb was finally achieved.

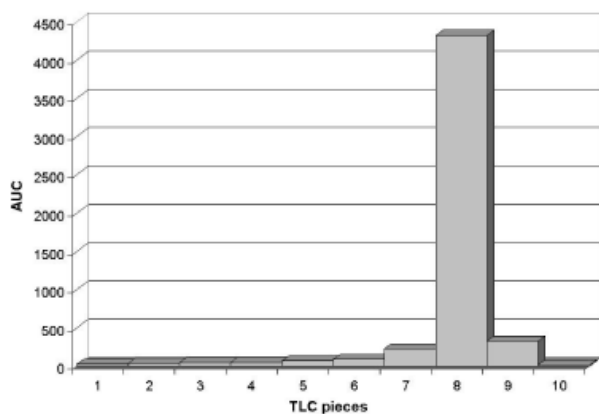

Fig. 5. Thin-layer chromatogram of Rb⁺ cation over silica paper using normal saline as the mobile phase, AUC: area under curve of the 511 keV peak in gamma spectrum.

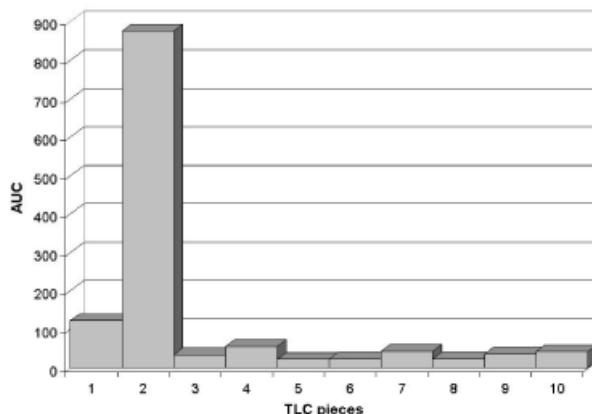

Fig. 6. Thin-layer chromatogram of Rb⁺ cation over silica paper using acetone as the mobile phase, AUC: area under curve of the 511 keV peak in gamma spectrum.

Table 4. Colorimetric assay and reagents used for chemical purity test [15]

Cation	Reagent	λ_{\max} [nm]	Molar coefficient of light absorption $\epsilon \times 10^{-3}$	pH	Color [ppm]	This work [ppm]	E.P. ¹ [ppm]	U.S.P. ² [ppm]
Iron	2,2-dipyridyl	522	8.65	3–9	pink	4	5	5
Titanium	Sodium chromotropate	480	11.4	2–5	yellow	1.5	10	5

¹ European Pharmacopoeia. ² United States Pharmacopoeia.

The production yield was 235.7 MBq/ μ Ah. Total production and formulation of [^{82m}Rb]Rb took about 60 min. Thin-layer chromatography showed that the radiochemical purity of [^{82m}Rb]Rb was > 95%. In contrast to other PET radiotracers for cardiac studies, [^{82m}Rb]Rb has a rather longer half-life that enables long data acquisition times for PET imaging or using coincidence systems. Column chromatography steps yielded a rather high specific activity injectable solution with minimum organic impurities. High chemical stability of the radiopharmaceutical, made it easier for autoclaving process. Biodistribution studies using Rb-81 radionuclide was performed in normal rats showing the accumulation of Rb cation in the bladder, GI and heart. Imaging studies showed that the activity reached its maximum in the rat heart 3.5 h post injection, which may be attributed to the presence of a large number of Na/K pumps in heart muscle.

Quality control

Due to the positron-emitting property of rubidium-82m and the selective diagnostic effects of this radionuclide, the strategy of formulating such a radionuclide as a cardiac diagnostic agent was one of our great interests. Gamma spectroscopy of the final solution showed a radionuclide purity higher than 99% showing the presence of 776, 554, 619, 511 keV gamma energies, all originating from ^{82m}Rb (Fig. 7).

Passing the final solution through a preactivated C₁₈ and Si Sep-Pak column prevented any changes in the color of final solution as well as wall absorption of the radionuclide, possibly due to the removal of organic impurities (Table 4). The radiochromatogram showed a major and distinct radio peak at the R_f of 0.80, related to Rb⁺ with normal saline as the eluent. In another system acetone was used as the mobile phase (Rb⁺ R_f = 0.1). Thus, the radiochemical yield was calculated to be more than 99% in each case, $n = 9$.

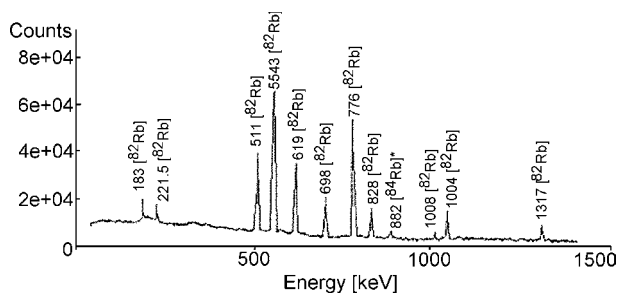

Fig. 7. Gamma spectroscopy scheme of the final ^{82m}Rb product.

Formulation

In order to exchange the media from simple Milli-Q[®] water to injectable biocompatible solution, the cation containing target solution was passed through a Si Sep-Pak column. The column was completely purged, using N₂ gas flow. The Rb-82m cation was finally eluted from the column by normal saline solution (maximum: 4 ml). This could easily help increasing the specific activity of the final target solution; considering a 25 ml volume of the target solution in the normal run in our settings. The final solution was then autoclaved for sterility.

Biodistribution in animal tissues

Due to the high solubility of monovalent rubidium cation in serum, the amount of radioactivity in blood remained constant during the first hour, while it slowly increased in the next couple of hours. This may be attributed to the Rb re-distribution from liver, lung and heart into circulation. The major excretion mode was through kidneys which has already been shown for water soluble cations such as Rb. The high activity content in the bladder was obvious during the first couple of hours.

The rate of activity loss was almost similar in the kidneys and bladder. In the first 6 h, a significant amount of the activity accumulated in the heart, which was due to the presence of Na⁺/K⁺ ATPase pump, resulting in a major peak at 2 h.

Regarding the high prevalence of this pump in myocardial cells, saturation of the pump is not the leading issue to the continuous absorption of Rb into myocardium. The amount of activity in intestine increased

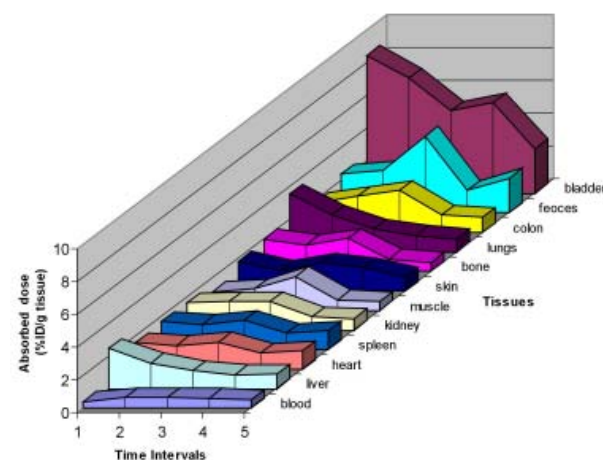

Fig. 8. Biodistribution of [⁸¹Rb]RbCl in organs of normal rats ($n = 5$) (% ID/g tissue); time intervals: 1:0.5 h, 2:1 h, 3:2 h, 4:4 h, 5:6 h.

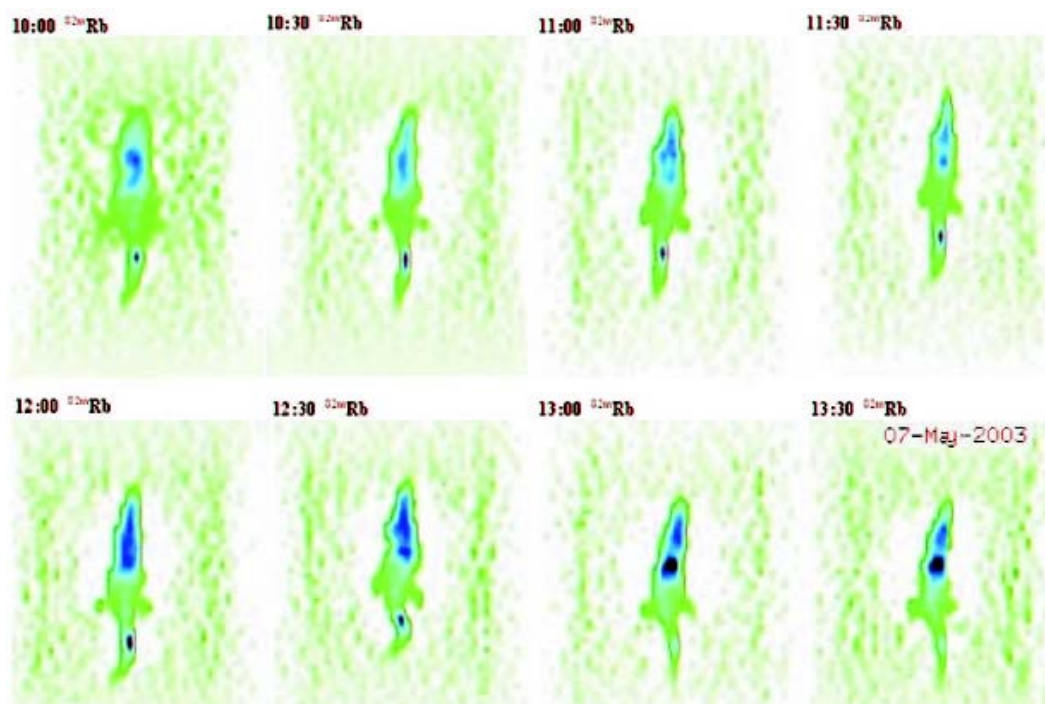

Fig. 9. Whole-body initial scans of Rb-82m injected dose (11.1 MBq) at time intervals (0.5 h up to 4 h) post-injection acquired by a dual-head co-incidence SPECT camera.

after some time, possibly due to the excretion of Rb into GI tract from gallbladder, followed by high Rb contents in foeces (Fig. 8).

Imaging studies

In order to confirm the possibility of radionuclide injection and biocompatibility to living animals for further biological and/or imaging studies, animal studies were performed. The pH of the sterile normal saline solution containing Rb-82m cation (specific activity of ≈ 296 MBq/ml), was adjusted between 5.5–7. The solution was then passed through a Cathivex 0.22 μ filter for sterility. The biodistribution of ^{82m}Rb was fast enough to perform scanning in animals.

Initial images in normal male rats 30 min after administration of 11.1 MBq of Rb showed a rather uniform distribution of the tracer. After an hour post-injection, the tracer was mostly concentrated in excretory organs like kidneys and liver. At the hour 2, the heart was distinctly observed in the middle of the chest cavity. After 3 h, most of the activity accumulated in the heart, while the background was significantly reduced (Fig. 9). Thus, in our animal models, the 3 h post-injection was the best scanning time. Further studies must be performed in order to optimize the injected dose/scanning properties in normal and cardially-injured rats, as well as comparison with other cardial agents.

Conclusion

Rubidium-82m can be a suitable substitute for Rb-82 for detection of CAD and related complications.

Pharmacological agents are commonly used for the stress portion of Rb-82 PET protocols due to its short half-life [2], but measurements may be easier using Rb-82m with a longer half-life. Sensitivity and specificity for infarct-related arteries and wall motion imaging were similar for Rb-82 and Tl-201, while Rb-82/Rb-82m are preferred due to PET technological advantages [17]. In this study, rubidium-82m was prepared via 15.4 MeV proton irradiation of krypton-82 gaseous target (30% enrichment). An activity of 1.3 GBq at EOB was obtained (235.7 MBq/ μ Ah). Radionuclide, radiochemical and chemical purity tests were performed prior to administration to rats. Biodistribution studies using Rb-81 showed tracer accumulation in the heart, GI and bladder followed by dual-head coincidence studies to determine the distribution of [^{82m}Rb]Rb in normal rats.

The method introduced in this research can be used for the production of large amounts of ^{82m}Rb for PET imaging in case of using Kr-82 samples with higher enrichment contents, while production yield was high enough to perform a few clinical studies.

References

1. Aboudzadeh M (1998) Selection of the proper nuclear reaction for the production of Kr-81m. IAEA Bull 17:41–43
2. Bateman TM (2004) Cardiac positron emission tomography and the role of adenosine pharmacologic stress. Am J Cardiol 94:2A:19D–24D
3. Blann M, Bislinghoff J (1991) Code Alice/Livermore 91. Lawrence Livermore National Laboratory, Internal Report, UCID-19614
4. Cherry SR, Carnochan P, Babich JW, Serafini F, Rowell NP, Watson IA (1990) Quantitative *in vivo* measurements

- of tumor perfusion using rubidium-81 and positron emission tomography. *J Nucl Med* 31;8:1307–1315
5. Jalilian AR, Mirzaii M, Rowshanfarzad P *et al.* (2004) Production, formulation, quality control, biodistribution and imaging properties of [^{18}F]-KF in normal rats for PET applications. *Iran J Nucl Med* 21:49–62
 6. Jalilian AR, Rowshanfarzad P, Sabet M, Novinrooz A, Raisali G (2005) Preparation of [^{66}Ga]Bleomycin complex as a possible PET radiopharmaceutical. *J Radioanal Nucl Chem* 264;3:617–621
 7. Kopecky P, Szelecsenyi F, Molnar T, Mikecz P, Tarkanyi F (1993) Excitation functions of (p,xn) reaction on ^{nat}Ti , monitoring of bombarding proton beams. *Int J Appl Radiat Isot* 44;4:687–692
 8. Lambrecht RM, Gallagher BM, Wolf AP, Bennett GW (1980) Cyclotron isotopes and radiopharmaceuticals-XXIX. $^{81,82m}\text{Rb}$ for positron emission tomography. *Int J Appl Radiat Isot* 31;6:2836–2842
 9. McGowan RL, Welch TG, Zaret BL, Bryson AL, Martin ND, Flamm MD (1976) Non-invasive myocardial imaging with potassium-43 and rubidium-81 in patients with left bundle branch block. *Am J Cardiol* 38;4:422–428
 10. Marwick TH, Shan K, Patel S, Go RT, Lauer MS (1997) Incremental value of rubidium-82 positron emission tomography for prognostic assessment of known or suspected coronary artery disease. *Am J Cardiol* 80;7:865–870
 11. Murata K (1989) Usefulness and limitations of myocardial scintigraphy at present. *J Cardiol* 19:593–597
 12. Pirich C, Schwaiger M (2000) The clinical role of positron emission tomography in management of the cardiac patient. *Rev Port Cardiol* 19:89–100
 13. Shea MJ, Wilson RA, Wilson CM *et al.* (1987) Use of short and long-lived rubidium traces for the study of transient ischemia. *J Nucl Med* 28:989–997
 14. Stoll HP, Huwer H, Vollmar B *et al.* (2000) Experimental validation of a new coronary guide wire labeled with rubidium 81/krypton 81m for continuous assessment of myocardial blood flow. *J Nucl Cardiol* 7;3:255–262
 15. Vogel AI (1976) A textbook of macro and semimicro qualitative inorganic analysis, 4th ed. Longman, Hong Kong
 16. Von Dahl J (2001) Assessing myocardial perfusion with positron emission tomography. *Z Kardiol* 90;11:835–847
 17. Williams KA, Ryan JW, Resnekov L *et al.* (1989) Planar positron imaging of rubidium-82 for myocardial infarction, a comparison with thallium-201 and regional wall motion. *Am Heart J* 118;3:601–610