

M. TKADLEČKOVÁ\*, P. MACHOVČÁK\*\*, K. GRÝC\*, K. MICHÁLEK\*, L. SOCHA\*, P. KLUS\*

## NUMERICAL MODELLING OF MACROSEGREGATION IN HEAVY STEEL INGOT

### MODELOWANIE NUMERYCZNE PROCESU MAKROSEGREGACJI W CIĘŻKIM WLEWKU STALOWYM

The paper presents new knowledge and experience from numerical modelling of macrosegregation in heavy steel ingot using ProCAST software. The main aim of numerical modelling realized under the conditions of the Department of Metallurgy and Foundry and Regional Materials Science and Technology Centre at VSB-TU Ostrava is the optimization of the production of heavy steel ingots produced in VÍTKOVICE HEAVY MACHINERY a.s. Input parameters of computation were determined by the real conditions of parallel experimental casting of a 90-ton steel ingot. The input data were also verified by thermal analysis and thermography measurement. The numerical results of macrosegregation were compared with the chemical analysis evaluated in a real ingot section. According to the comparison, attention will be focused next on determination of the effect of boundary conditions of filling and solidification of the ingot on the size of macrosegregation.

*Keywords:* steel, ingot, macrosegregation, ProCAST, modelling

W artykule przedstawiono doświadczenia i nowe informacje uzyskane o procesie makrosegregacji w wielkogabarytowym wlewkowi stalowym przy pomocy modelowania numerycznego z użyciem oprogramowania ProCast. Głównym celem badań o charakterze modelowania numerycznego prowadzonych na Wydziale Metalurgii i Odlewnictwa oraz w Regionalnym Centrum Technologii i Inżynierii Materiałowej VSB-TU Ostrava jest optymalizacja produkcji wielkogabarytowych wlewków stalowych produkowanych w VITKOVICE HEAVY MACHINERY a.s. Dane wejściowe do obliczeń zostały wyznaczone w oparciu o opracowaną analizę rzeczywistych warunków odlewania stacjonarnego 90-tonowego wlewka stalowego. Zostały one dodatkowo zweryfikowane poprzez analizę termiczną i pomiary termograficzne. Wyniki obliczeń numerycznych porównano z wynikami analizy chemicznej przeprowadzonej dla wlewka rzeczywistego. Uzyskane rezultaty upoważniają do podjęcia w dalszej części badań problematyki dotyczącej określenia wpływu warunków brzegowych napełniania wlewnicy i krzepnięcia wlewka na wielkość procesu makrosegregacji.

### 1. Introduction

VÍTKOVICE HEAVY MACHINERY a.s. (VHM) is a traditional producer of large machinery components. The typical products of this company are crankshafts, propeller and connecting shafts, rotor shafts for wind power plants, forged parts for the container of pressurizers, steam generators, heat exchangers and collectors for both conventional and nuclear power engineering. For these products it is necessary to cast ingots weighing up to 200 tons. Typically steel grades for these products are structural carbon-manganese, low alloyed; middle alloyed and tool steels [1]. The main precondition of the competitiveness of any steel plant is production of a consistently high quality [2]. However, despite significant advances in technology of the production of steel ingots, we can find defects in the final forgings that may be caused due to the non-uniform cast microstructure of an ingot, as well as the macrostructure, which is the result of plastic deformation dur-

ing the subsequent process of the forming. One of the ways to monitor and optimize the production steps from the casting up to the process of forming is the use of methods of numerical modelling [3].

The main aim of numerical modelling in ProCAST software realized under the conditions of the Department of Metallurgy and Foundry (DMF) and Regional Materials Science and Technology Centre (RMSTC) at VSB-TU Ostrava is the optimization of the production of heavy steel ingots produced in VHM, especially focused on minimization of macrosegregation. Based on available literature [e.g. 4-12], it was confirmed that the macrosegregation is a function of chemical composition of the steel, of the time and course of solidification. This means that in order to minimize the extent of the segregation, it is not sufficient to change only the geometry of the mould, but it is also necessary to optimize the regime of the casting and primarily the control of solidification [13].

\* VŠB-TECHNICAL UNIVERSITY OF OSTRAVA, FACULTY OF METALLURGY AND MATERIALS ENGINEERING, DEPARTMENT OF METALLURGY AND FOUNDRY, AND REGIONAL MATERIALS SCIENCE AND TECHNOLOGY CENTRE, 17. LISTOPADU 15/2172, OSTRAVA-PORUBA, CZECH REPUBLIC

\*\* VÍTKOVICE HEAVY MACHINERY A.S., OSTRAVA, CZECH REPUBLIC

## 2. Numerical modelling

The attention of numerical modelling was/is focused on verification of macrosegregation in a 90-ton steel ingot using numerical modelling in the ProCAST simulation software. The conditions of the setting of the numerical model were based on the real conditions of the experimentally parallel cast 90-ton steel ingot produced in VHM.

As was published in [3, 14, 15], the numerical solution of each task is divided into three stages: pre-processing, processing and post-processing.

### 2.1. Pre-processing

Pre-processing included the geometry modelling and the computational mesh generation process, and definition of calculation.

#### 2.1.1. Geometry modelling and mesh generation

The large ingots are specific in terms of simulation. Shapes are usually simple, but one must keep in mind the great size of casting and adapt the quality of mesh and definition of simulation.

The first question is to use or not to use symmetry. The geometry usually allows a user to use one or two symmetry planes. For the simulation of filling it is recommended to use the whole geometry. The one reason is that the inlet of metal must be set up in contact with symmetry plane and symmetry plane slightly influences way of ingot filling. The second reason is that the field of velocity vectors is not complete in horizontal cut. For better observation of the metal's behaviour during the mould filling one should use the whole ingot geometry [16].

The whole 3D ingot geometry was created in the CAD system SolidWorks. The comparison of the real and CAD geometry of the casting system is shown in Fig. 1 [14].

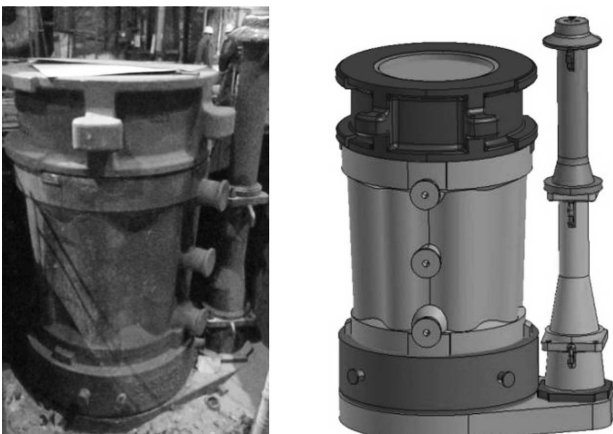

Fig. 1. Comparison of the real and CAD geometry of the casting system of a 90-ton ingot [15]

The computational mesh was generated in Visual-Mesh, which is a part of packet of ProCAST software. In Fig. 2 is the final computational mesh of the casting system.

When large ingots are modelled, the mesh size becomes very large with respect to the thermal gradients, especially

in the early stages of cooling. In order to have appropriate answers (i.e. more accurate temperatures), it is advised to generate a few layers (of a few mm in thickness) inside the ingot, as well as inside the mould [17].



Fig. 2. View of the final computational mesh of the casting system

#### 2.1.2. Parameters of calculation

Determination of some boundary, operating and initial conditions is usually not relatively difficult. In our case, the modelled area was clearly defined by the geometry of the casting system of the 90-ton ingot [13].

The casting temperature of the steel was defined according to real casting conditions of the experimentally cast ingot in VHM.

The character of the filling was necessary to simplify - the EAF capacity in VHM is 70 tons so the larger ingots are cumulated from two or three heats. But during the numerical simulation, the filling was simulated in one step (without interruption during the changing of the ladles).

The properties of refractory materials were determined as indicated in the data sheets provided by the manufacturer.

The quality of the results of the numerical simulation of the volume defects in ingots, especially macrosegregation of elements, is mainly determined by the quality of the thermodynamic properties of steel and of mould material, respectively by the applied conditions of heat transfer among the individual parts of the casting system and by the definition method of the heat losses. And here is where the first difficulties can be encountered.

First, the grade of the steel or the material of the mould may not be included in the basic material database of the ProCAST software. To solve this issue the CompuTherm above-standard module needs to be used. Based on the definition of chemical composition of the steel, the thermodynamic database CompuTherm allows the user to calculate thermodynamic parameters for any new material, or to follow the changes of the thermo-physical data relating to changes of chemical composition [17]. Another way is to use the experimental method of thermal analysis [18, 19], or it is also possible to use information from literature.

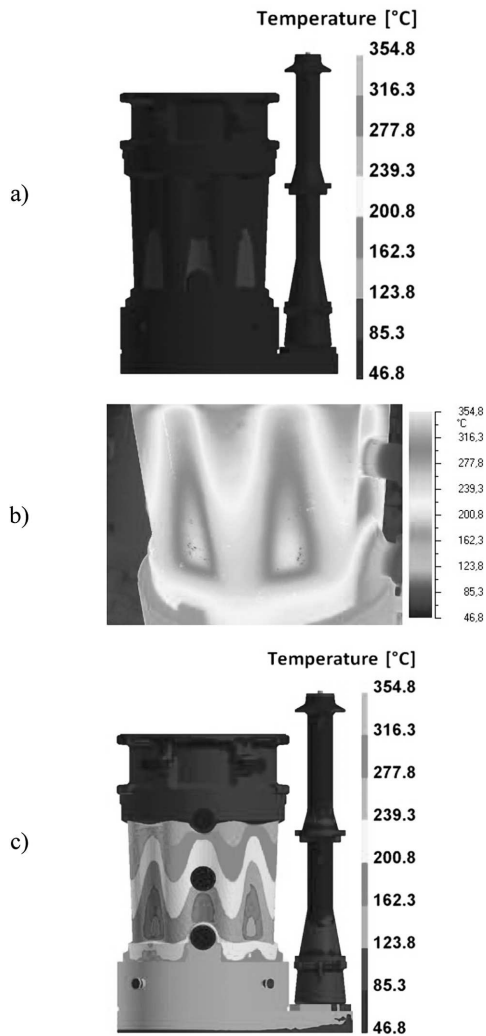

Fig. 3. The comparison of the temperature on the mould surface a) before and c) after adjustment of the coefficients of heat transfer with c) the thermography measurement in the moment after filling [14]

Also, the definition of the heat transfer coefficients among the individual components of the casting system is not simple. The constant values in the range of 100 to 1,000  $\text{Wm}^{-2}\cdot\text{K}^{-1}$  are usually given in literature. To be sure that the heat transfer conditions are set correctly, the thermography measurement of the temperature fields and heat flux of the individual parts of the casting system during the experimental casting of the 90-ton ingot was ensured. According to the results of thermography measurements it was necessary to adjust the heat transfer coefficients among the individual parts of the casting system depending on time, as was published in [14]. The comparison of the evolution of the temperature on the mould surface before and after adjustment of the coefficients of heat transfer with the thermography measurement in the moment after filling is in Fig. 3.

## 2.2. Processing

Large ingot filling and solidification needs some special treatment. The parameters of calculation are set in RUN PARAMETERS. The calculation of the filling and solidification of steel ingots by the method of finite elements can be made separately – it is good not to include the mentioned steps in one simulation.

The first reason is the possibility of visualization of results from filling and from solidification individually. The second cause is due to the fact that the filling times are usually very long on one side, and other side, rather high velocities are leading to quite small time steps. As a result, the computing times are often quite long [16].

Sometimes, the user may not be interested in the filling of the last percents (e.g. the end of the filling of a head). This setting can also lead to shorter computational time. Therefore, during the simulations, the effect of the one time step of the filling of the head of the casting system with the remaining 10% of the steel on the final surface temperature of the mould was tested. This time step is defined using the run parameters ENDFILL. This means, if the ENDFILL=0.90, once 90% will be reached, the remaining 10% of the steel will be filled in one time step [17]. Fig. 4 shows the character of the mould filling with the steel and the final filling time in seconds. A real time of the filling during the experimental casting of 90-ton ingot was 56 minutes [1].

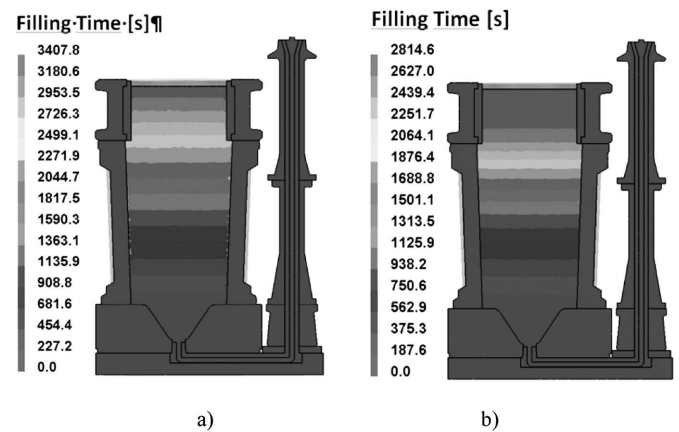

Fig. 4. a) Character of the filling corresponding to the real casting conditions of 90-ton ingot b) character of the filling using run parameters ENDFILL=0.90 [1]

The computational time of our one variant was around 96 hours using dual processor cores. However, to the time of your own computation it is necessary to add a preparation of the simulation and evaluation of achieved results. The computational time is also influenced by the step numbers of the data save. The calculation with macro-segregation in the phase of solidification was/is much longer – the computation time of 3D mesh was around 170 hours.

The computation of macrosegregation is possible due to the MACRO module – in RUN PARAMETERS it is necessary to activate using value “1”. The MACRO module is integrated with thermodynamic parameters of cast materials, such as liquidus temperature and solidus temperature. The liquid species conservation is governed by the equation [20]:

$$f_l \rho_l \frac{\partial c_l^m}{\partial t} + f_l \rho_l v_l \cdot \nabla c_l^m = \nabla \cdot (f_l \rho_l D_l^m \nabla c_l^m) + (c_l^m - c_{sl}^m) \frac{\partial}{\partial t} (\rho_s f_s) + \frac{S \rho_s D_s^m}{l} (c_s^m - c_{sl}^m) \quad (1)$$

The solid species conservation describes the equation (2)

$$f_s \rho_s \frac{\partial c_s^m}{\partial t} = (c_{sl}^m - c_s^m) \left[ \frac{\partial}{\partial t} (\rho_s f_s) + \frac{S \rho_s D_s^m}{l} \right] \quad (2)$$

where  $c$  is concentration,  $m$  is species,  $l = f_s d_2 / 6$  is diffusion length,  $S = 2 / d_2$  is interfacial area concentration,  $d_2$  is secondary dendrite arm space,  $sl$  is solid and liquid interface and  $D$  is diffusivity.

Obviously, the macrosegregation is influenced by the natural convection during solidification – therefore it is recommended to also activate the FLOW module. The temperature dependence of density for liquid metals is linear:

$$\rho^m(T) = \rho_{ref}^m + \left( \frac{\partial \rho}{\partial T} \right)_m (T - T_{ref}^m) \quad (3)$$

where  $\rho_{ref}^m$  reference density

$T_{ref}^m$  reference temperature

The liquid density is calculated by equation (4):

$$\rho(T)^{-1} = \sum_m \frac{c_l^m}{\rho^m(T)} \quad (4)$$

where  $c_l^m$  liquid concentration.

### 2.3. Postprocessing

Because the simulation of the filling and solidification of the ingot was done separately in two steps, the simulation results can also be divided into the results obtained from the calculation of filling and results obtained by the calculation of solidification.

The numerical results of macro segregation of elements, especially such as carbon, sulphur, manganese, copper, nickel, and phosphorous were compared with the chemical analysis of elements from the half cross section of real ingot. Chemical composition was analysed along the height of the real axis of the ingot and then in the next four straight lines that were parallel to the axis. The distance of these parallel lines were 200, 450, 650 and 850 mm. The analysed places are shown in Fig. 5 [21].

The standard method used in metallurgical analytics – analyses using optical emission spectrometers – was not applicable due to the large number of required analyses. Thus, the mobile optical spectrometer SPECTROTEST was used for analysis of Mn, Si, Cu and Ni content. Its great advantage was that the analysis could be carried out directly on the ingot without sampling.

Due to the low content of sulphur it was evident from the very beginning that there is no other alternative than to use the laboratory analysis of a combustion analyser, with the lowest possible detection limit and the greatest accuracy. A sample of chips weighing from 0.5 to 2.0 g was need for this method. Thus the surface of ingot cross-section was drilled and chips were analysed on an automatic analyser LECO CS-600. Sulphur and carbon were analysed on this unit. Phosphorus content was also determined on samples taken from the chips. A larger sample weight of chips was needed for this analysis, at least 2 grams [21].

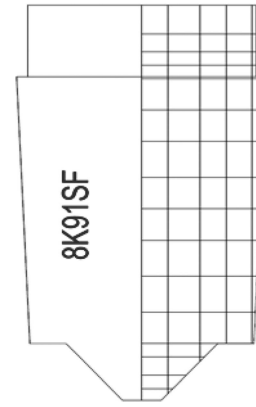

Fig. 5. The grid of the analysed point on the cross section of half body of the real ingot [21]

The results of the simulations were processed in post-processor Visual Viewer. The change of chemical composition along the height of the central axis of the ingot was found using a plot of the evolution of the element content in time or the plot of the profiles. The final content of the elements were taken approximately 20 hours after the end of the filling – the whole volume of the ingot body was solid.

### 3. Discussion of results

Before comparison of experimental and numerical results of macrosegregation, it was necessary to consider these differences:

- As was mentioned above, the EAF capacity in VHM is approximately 70 tons, so the experimental ingot was cumulated from two heats. Each of these two heats had intentionally different content of copper and nickel in order to determine mixing of these two heats in the solidified ingot. Content of the other elements was targeted at the same level. In numerical modelling it was not possible to simulate the change in chemical composition; therefore the constant contents of the elements during whole simulation of filling were used.
- If we compute macro segregation, it is necessary to consider these limitations:
  - no solid movement,
  - no grain sedimentation
  - fully equixed dendrites, no columnar dendrites.
- Because we computed the production process of ingot in two steps, the initial conditions in the setting of macrosegregation simulation during solidification were extracted from the phase of the filling. But during the filling, the thin solid crust on the interface of mould and ingot was created. Therefore, in this thin solid crust, the macrosegregation was not possible to compute – in Fig.6 with examples of profiles of carbon macrosegregation, seen as a thin, violet edge with the lowest concentration of the valuated content of the element.



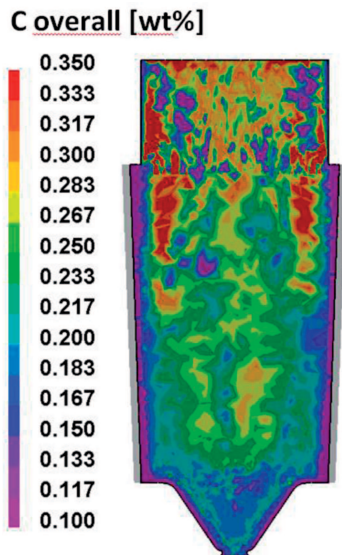

Fig. 6. The profiles of carbon macrosegregation with thin, violet edge with the lowest concentration of the valuated content of the element due to the extract results from filling [1]

During the numerical simulation of macrosegregation, two types of chemical composition were tested. In the first simulation (NM1), the complex chemical composition was defined according to the standard. In the next simulation (NM2), the composition was limited on the most important elements, such as C, Mn, Si, Cu, Ni, P and S. In Table 1 the chemical composition of two heats and the chemical compositions used in numerical modelling are compared.

In Fig. 7 the macrosegregation of carbon (a), sulphur (b), copper (c) and nickel (d) along the height of the central axis of the ingot from the simulation with complex chemical composition (NM1) is compared. In the case of carbon and sulphur a very good compliance with the experimental data was achieved. But in the cases of copper, nickel phosphorus,

manganese or silicon, there was not such a good evolution trend in the macro segregation of these elements. Therefore, the chemical composition was changed on the NM2. Also, the ambient temperature was adjusted. The simulation runs on four processors for approximately 150 hours.

TABLE 1

The comparison of chemical composition of both heats for the experimental ingot and the two chemical compositions of the steel used during simulation

| Element | Heat No.1    | Heat No.2    | Weighted Average | NM1    | NM2    |
|---------|--------------|--------------|------------------|--------|--------|
| C       | 0.194        | 0.2          | 0.196            | 0.2    | 0.2    |
| Mn      | 1.3          | 1.27         | 1.288            | 1.3    | 1.3    |
| Si      | 0.26         | 0.27         | 0.264            | 0.3    | 0.3    |
| P       | 0.006        | 0.007        | 0.0064           | 0.006  | 0.006  |
| S       | 0.0013       | 0.0023       | 0.0017           | 0.0010 | 0.0018 |
| Cu      | <b>0.13</b>  | <b>0.46</b>  | 0.26             | 0.2    | 0.2    |
| Ni      | <b>0.506</b> | <b>0.118</b> | 0.353            | 0.5    | 0.5    |
| Cr      | 0.112        | 0.138        | 0.112            | 0.1    | —      |
| Mo      | 0.04         | 0.04         | 0.04             | 0.040  | —      |
| V       | 0.003        | 0.003        | 0.003            | 0.003  | —      |
| Al      | 0.021        | 0.023        | 0.0218           | 0.020  | —      |

In Fig. 8 a comparison of the macrosegregation of Cu and Ni after adjustment of the chemical composition is shown. As can be seen, the trend of the evolution in macrosegregation in the central axis of the ingot body led to more appropriate results. The similar better results were also achieved for manganese, phosphorus and silicon. On the other hand, the content of the carbon and sulphur was in the central axis is more than once higher than in the previous case.

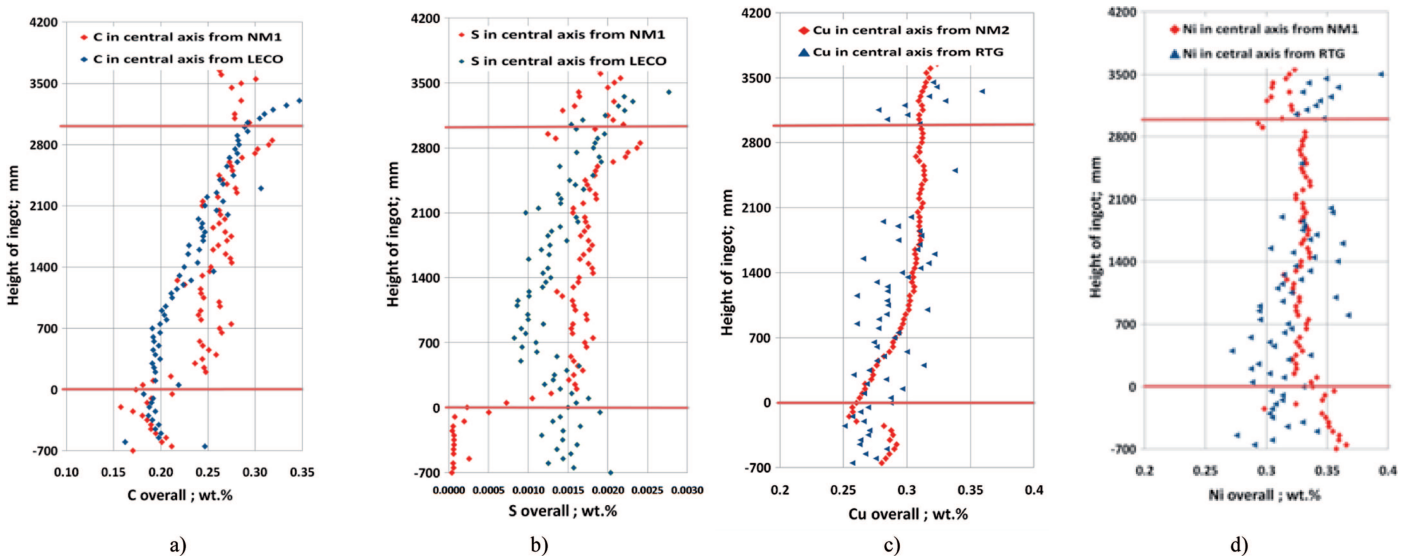

Fig. 7. The comparison of macrosegregation of carbon (a), sulphur (b), copper (c) and nickel (d) along the height of the central axis of the ingot from the simulation with complex chemical composition (NM1) with the real data from chemical analysis

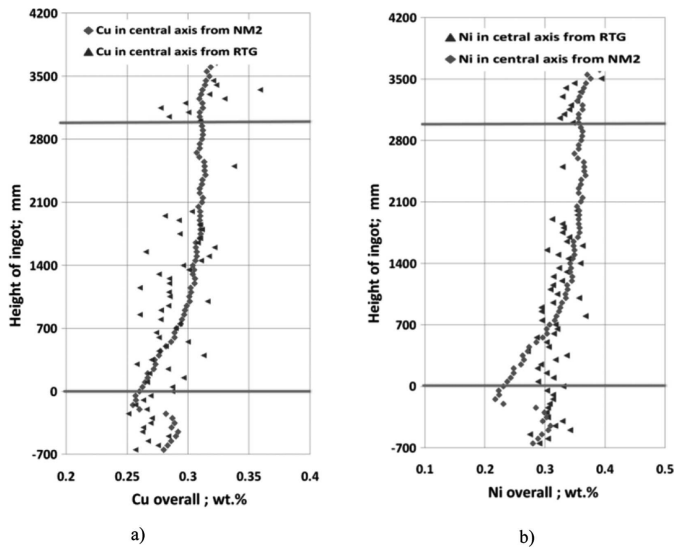

Fig. 8. The comparison of the macrosegregation of Cu (a) and Ni (b) after adjustment of the chemical composition in NM2 with the real data from chemical analysis

#### 4. Conclusion

The paper deals with the comparison of results of the chemical heterogeneity in the central axis of the cross section of the half ingot body from the numerical simulation of macrosegregation in real a 90-ton steel ingot produced in VÍTKOVICE HEAVY MACHINERY a.s. with the results of experimental measurement.

The numerical simulations are performed in the ProCAST software at the Department of Metallurgy and Foundry under the auspices of the Regional Material Science Centre and Technology of the VŠB - Technical University of Ostrava.

The aim of the simulations is to optimize the conditions of casting and solidification of heavy forging ingots with an emphasis on minimizing the macrosegregations.

In order for the default version of the numerical model of filling and solidification of the steel ingot to correspond with the real solidification conditions as accurately as possible, it was found that:

- It is good to verify the temperature on the surface of the mould using the thermography measurement during parallel experimental casting of the real steel ingot and to use the experimental results of heat transfer coefficients for adjustment of the interface among the components of the casting system in the numerical model,
- Especially for the simulation of macro segregation depending on boundary condition (such as casting speed, casting temperature and so on), it is also necessary to verify the width of the two-phase zone of the steel (that means the temperature of liquidus and solidus), which specifies the predisposition to the origination of segregations and influences the homogeneity of ingot.
- The numerical results of macrosegregation showed that final evolution of the element depends on the character of the heat transfer, chemical composition vs. thermodynamic parameters, and also on the computational mesh density. For this reason, additional attention of the research will

be focused on the verification of the mesh quality and on the simulation of the filling and solidification in one step.

#### Acknowledgements

This work was financially supported by Program Project TIP No. FR-TI3/243 of Ministry of Industry and Trade of the Czech Republic and as a part of the Project No. CZ.1.05/2.1.00/01.0040 (ED0040/01/01) Regional Material Technology Research Centre under the Operational Program Research and Development for Innovation funded by EU Structural Funds and by the State budget.

For the technical support with the numerical simulations we thank Mr. Marek Kovač from MECAS ESI s.r.o.

#### REFERENCES

- [1] P. Machovčák, A. Opler, M. Tkadlečková, K. Michalek, K. Gryc, V. Krutis, M. Kováč, The utilization of Numerical Modelling To optimize the Production of Heavy Forging Ingots in Vítkovice Heavy Machinery, a.s. In: 1<sup>st</sup> International Conference on Ingot Casting, Rolling and Forging ICRF, 3.-7. Aachen, Germany (2012).
- [2] K. Janiszewski, Influence of slenderness ratios of a multi-hole ceramic filters at the effectiveness of process of filtration of non-metallic inclusions from liquid steel, Archives of metallurgy and Materials. **57**, 1, 135-143 (2012).
- [3] M. Tkadlečková, K. Michalek, P. Klus, K. Gryc, V. Sikora, M. Kováč, Testing of numerical model settings for simulation of steel ingot casting and solidification. In: 20th Anniversary International Conference on Metallurgy and Materials METAL 2011. Brno, EU, 61-67 (2011).
- [4] N.A. Zjuban, S.I. Zuljev, Vlijanije parametrov izgotovljenja krupnych kuznecnykh slitkov na formirovanije optimalnoj struktury osevoj zony. METALLURG, 12, 38-39 (2001).
- [5] N.A. Zjuban, et al. Issledovanie defektov litoj struktury osevoj zony slitkov stali 38XHNZ3MFA i ich povedenje vo vremja osadki. STAL **80**, 4, 24-27 (2011).
- [6] A.N. Smirnov, Ulucsenije kacestva slitkov i zagotovok putem vibroimpulsnogo vozdejstvija pri ich zatverdevanii. STAL **66**, C.4, 14-20 (1997).
- [7] V.A. Efimov, A.S. Eldarchanov, A.S. Nuradinov, Vlijanije vibracionnoj obrabotki na strukturu i svojstva slitka stali 60. STAL **71**, 12, 15-17 (2002).
- [8] L.J. Nedeljkovic, V.L. Pilyushenko, A.N. Smirnov, Effect of pulsating stirring of liquid core on solidification of large steel ingots. Ironmaking steelmaking **17**, 6, 414-423 (1991).
- [9] L. Hallgren, S. Takagi, A. Tilliander, Effect of nozzle type and swirl on flowe patern for initial filling conditions in the mould for up-hill terminy. STEEL RES. **78**, 3, 254-259 (2007).
- [10] L. Hallgren, et al. A First Attempt to Implement a Swirl Blade in Production of Ingots. ISIJ INTERNATIONAL **50**, 12, 1763-1769 (2010).
- [11] P.G. Joensson, A. Tilliander, S. Yokoya, Z. Zhang, A numerical study of swirl blade effects in uphill teemingcasting. ISIJ INT. **50**, C.12, 1756-1762 (2010).
- [12] T. Telejko, M. Karbowniczek, W. Bialowas, Symulacja numeryczna procesu krzepniecia wlewkw kuziennych w formach chlodzonych woda. Metalurgia i odlewnictwo **16**, 2, 274-295 (1990).
- [13] M. Tkadlečková, K. Gryc, L. Socha, K. Michalek, P. Klus, P. Machovčák, Comparison of numerical results with thermography measurement. In: 21<sup>st</sup> In-

- ternational Conference on metallurgy and Materials METAL 2012, Brno, Czech Republic, EU. 59-65 (2012).
- [14] M. Tkadlečková, K. Gryc, P. Machovčák, P. Klus, K. Michalek, L. Socha, M. Kováč, Setting a Numerical Simulation of Filling and Solidification of Heavy Steel Ingots Based on Real Casting Conditions. MATERIALI IN TECHNOLOGIJE **46**, 4, 399-402 (2012).
- [15] M. Tkadlečková, K. Gryc, K. Michalek, P. Klus, L. Socha, P. Machovčák, M. Kováč, Verifikace vlivu okrajových parametrů lití ocelových ingotů na velikost objemových vad. Hutnické listy, LXV, 2, 3-7 (2012).
- [16] M. Kováč, Large castings – INGOT. ProCAST 2010. User Guide (2011).
- [17] ProCAST 2009, Release Notes & Installation Guide. ESI Group (2009).
- [18] B. Smetana, S. Zlá, M. Žaludová, J. Dobrovská, P. Kozelský, Application of High Temperature DTA to Micro-Alloyed Steels. Metalurgija, **51**, 1, 121-124 (2012).
- [19] K. Gryc, B. Smetana, K. Michalek, V. Sikora, M. Tkadlečková, S. Zlá, M. Žaludová, J. Dobrovská, Connection of basic and applied research in the field of thermo-physical study of the properties of steels, slag and ferro-alloys In: 20th Anniversary International Conference on Metallurgy and Materials: METAL 2011. Brno, EU, 125-131 (2011).
- [20] ProCAST User Guide 2009 – macrosegregation in ProCAST. JGU, ESI US R&D, Columbia, Maryland.
- [21] P. Machovčák, A. Opler, Z. Carbol, A. Trefil, K. Merta, J. Zaoral, M. Tkadlečková, K. Michalek, In: 21<sup>st</sup> International Conference on metallurgy and Materials METAL 2012, Brno, Czech Republic, EU. 53-58 (2012).

Received: 10 February 2012.