

J. MICHALCZYK*

DEVELOPMENT, MODELLING AND ANALYSIS OF THE NEW COMBINED BOTTOMLESS SLEEVE EXTRUSION PROCESS

OPRACOWANIE, MODELOWANIE I ANALIZA PARAMETRÓW NOWEGO PROCESU ZŁOŻONEGO WYCISKANIA TULEI BEZ DNA

An intensive industry development assuring high production quality should take place with the rational use of production machinery and equipment, low material and energy consumption per production unit, and at the maximum efficiency of processes. High quality of relatively cheap of semi-finished and finished products is achieved as a result of using non-waste manufacturing methods, which include e.g. the rolling, drawing and extrusion processes. The effective enhancement of production quality may be achieved by employing contemporary modelling and optimization methods in the design of new technological processes. In plastic working processes, during the design and optimization of new technologies, numerical modelling plays a crucial role. It brings about considerable time and material savings. It enables the determination of the basic parameters of processes and prediction of any possible gains or losses associated with the implementation of new technological solutions. The article reports the results of numerical modelling studies on the processes of combined extrusion of sleeves, where solutions were implemented, which allowed bottomless sleeves to be manufactured by these methods, without having to use the operation of mechanical cutting off the bottom formed after the extrusion process. In one of the cases, by using working tools of the appropriate design, a process of non-waste extrusion of a through sleeves was even achieved. The basic advantage of the proposed solutions is the single-operation nature of processes with a simultaneous reduction of the energy-force parameters compared to the traditional methods of manufacturing these types of products.

Keywords: extrusion, complex extrusion, deep sleeves

Intensywny rozwój przemysłu, zapewniający wysoką jakość produkcji, powinien odbywać się przy racjonalnym wykorzystaniu maszyn i urządzeń produkcyjnych, niskim zużyciu materiałów i energii na jednostkę produkcji oraz przy maksymalnej wydajności procesów. Wysoką jakość stosunkowo tanich półwyrobów i wyrobów uzyskuje się w wyniku stosowania bezodpadowych metod wytwarzania, do których zalicza się m.in. procesy walcowania, ciągnięcia i wyciskania. Efektywne podwyższenie jakości produkcji może być osiągnięte drogą wykorzystania podczas projektowania nowych procesów technologicznych współczesnych metod modelowania i optymalizacji. W procesach przeróbki plastycznej podczas projektowania i optymalizacji nowych technologii niezwykle rolę odgrywa modelowanie numeryczne. Zapewnia ono znaczne oszczędności czasowe i materialne. Pozwala na określenie podstawowych parametrów procesów i przewidywanie ewentualnych strat bądź zysków w związku z zastosowaniem nowych rozwiązań technologicznych. W niniejszej pracy przedstawiono wyniki badań modelowania numerycznego procesów złożonego wyciskania tulei, gdzie zastosowano rozwiązania pozwalające na wytwarzanie tymi sposobami tulei bez dna, bez konieczności stosowania operacji mechanicznego odcinania powstałego po procesie wyciskania denka. W jednym z przypadków poprzez zastosowanie odpowiedniej konstrukcji narzędzi roboczych osiągnięto nawet proces bezodpadowego wyciskania tulei przelotowej. Podstawową zaletą proponowanych rozwiązań jest jednooperacyjny charakter procesów przy jednoczesnym spadku parametrów energetyczno – siłowych w stosunku do tradycyjnych sposobów wytwarzania tego typu wyrobów.

1. Introduction

Although popularly called non-waste, plastic working processes not always yield a final product that does not leave a production waste. A classic example is the section or tube direct extrusion process, where the final process phase leaves in the die a waste in the form of the so called "butt" [1,2]. In order to remove the waste, mechanical cutting off with a saw is used, and then the waste is taken away from the contained

with a punch [2]. The waste size is dependent on the geometry of the die being used. Another method for manufacturing tube semi-finished and finished products, which is known and used in practice, is the indirect extrusion process [1,2]. To obtain finished product in the form of a through sleeves or semi-finished products to be further processed, e.g. by rolling [9], forcing through [11] or rotational extrusion [2] of tubes, it is necessary to employ mechanical cutting to remove the bottom of the sleeves. This creates the need for performing

* CZĘSTOCHOWA UNIVERSITY OF TECHNOLOGY, FACULTY OF MATERIAL PROCESSING TECHNOLOGY AND APPLIED PHYSICS, INSTITUTE OF MODELLING AND AUTOMATION OF PLASTIC WORKING PROCESSES, 42-200 CZĘSTOCHOWA, 19 ARMII KRAJOWEJ STR., POLAND

an additional technological operation, using additional tools, whereby the productivity and profitability is reduced.

At present, when designing manufacturing processes, great emphasis is placed on production economics in addition to the good quality of products manufactured. The degree of material yield and energy intensity of the process have a major effect on the manufacturing costs [10,12,13].

It the conception of process of extrusion in present work was introduced was complex sleeve during which it thanks to use of additional tool in of funnel cutting in final stage figure sets the process of cutting off bottom and removing him from container. Use of such solution will permit on elimination the necessity of mechanical applying of cutting off bottom and moreover the suitable selection of geometry of tools makes possible receiving waste about smaller mass. It investigations were subjected was process applying variables parameters: value the given deformation, initial temperature of batch, speed the move forward of tools and results were passed across them statistical composition. The analyses were compared with primitive process extrusion from bottom without applying cutting funnel.

2. Processes developed for the purposes of manufacturing through blanks

References [2,3,4] report concepts and studies concerning new methods for extruding bottomed sleeves, where investigation results are achieved which show that by applying those technologies the energy-force parameters of the extrusion process could be reduced by 40% compared to the traditional indirect and direct extrusion methods.

Investigations were carried out into the extrusion of deep hollows, i.e. ones whose overall height is more than 2.5 times the internal diameter of the product. Studies were also done on manufacturing axially symmetrical through hollows and bottomed hollows of complex shapes (Fig. 1).

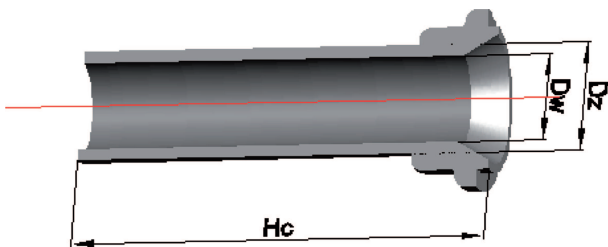

Fig. 1. A model of an extruded through hollow

For testing the process of extruding through hollows, as shown in Fig. 1, the double-sided extrusion method was used [6], with the difference that a ring was used, whose purpose was to minimize or eliminate the production waste. This solution is the subject of the Patent Application P. 397758, while the initial concept was based on the Patent P 206467.

The model of the tool for carrying out the complex extrusion method is shown in Fig. 2.

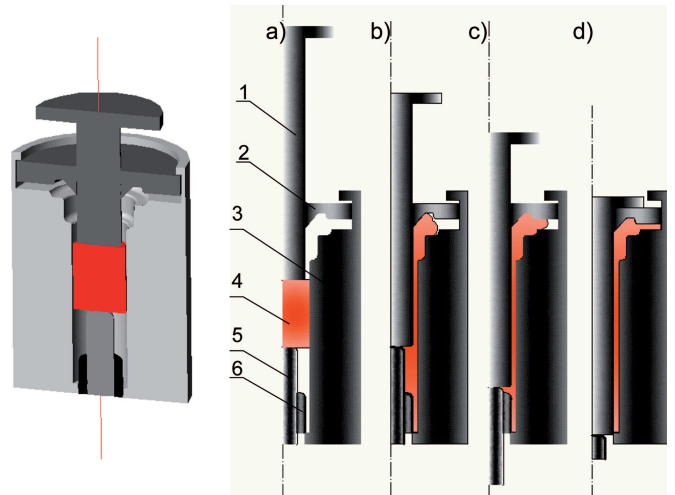

Fig. 2. The tool model and the method for double-sided extrusion a) stage I, b) stage II, c) stage III, d) finished product [8] 1.upper punch with pressure plate, 2. die forging, 3. container, 4. perform, 5. bottom punch, 6. ring

Based on the numerical analysis of the extrusion process it was found that it was possible to manufacture bottomed sleeves and flanged through sleeves by using a single-operation double-sided complex extrusion method.

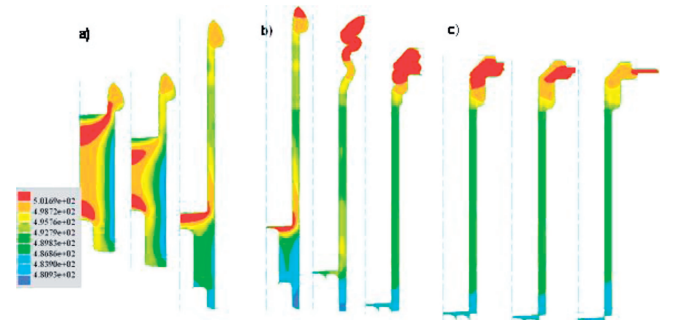

Fig. 3. Numerical modelling of the process of extrusion of a flanged through sleeve; a) double-sided sleeve, b) thick-walled sleeve reduction and extrusion, c) bottom cutting off

The tests were carried out using the AZ31 model material that was deformed at a temperature of 400°C at a velocity of 50 mm/s. During the numerical analysis of the problem, computer simulations of the process of extrusion of similar sleeves products were performed to compare the energy-force parameters. The diagrams of the dependence of extrusion force on ram path were compared.

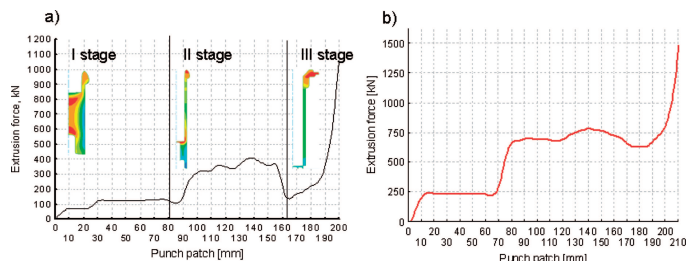

Fig. 4. The diagrams of the relationship of extrusion force versus ram path: a) double-side complex extrusion; b) indirect extrusion

The numerical modelling showed that employing an extrusion process of a specific strain scheme, that is double-sided

complex extrusion, yielded effects in the form of a potential for manufacturing axially symmetrical flanged hollow blanks and reducing the force-energy parameters compared to indirect forming of similar blanks by the indirect extrusion method, as shown in Fig 4. When developing the deep bottomed hollow extrusion processes it was disclosed based on numerical and experimental studies [2,3,4] that the developed technology of complex sleeves extrusion using a movable ring [5] brought about much better results in terms of force parameters than the developed double-sided complex extrusion method [6] did. Both the maximum extrusion forces and the mean values from the entire process were lower, and the behaviour of the curve of the relationship of extrusion force versus ram path indicated that the tools were considerably less loaded in individual process stages. Therefore, an idea arose to develop on this basis an alternative method for producing bottomless hollows.

3. The concept behind the process

The idea behind the implementation of the new solution is to manufacture either simple or complex axially symmetrical long through sleeves, i.e. ones in which the overall height H_c is 2.5 times greater than the internal diameter D_w (Fig. 1). For developing this extrusion method, the original approach of complex extrusion of deep bottomed sleeves using a movable pilot sleeve was utilized, for which the background and theoretical and experimental studies are reported in references [3,7]. A model of the tool for carrying out the complex bottomless sleeve extrusion process is shown in Fig. 5.

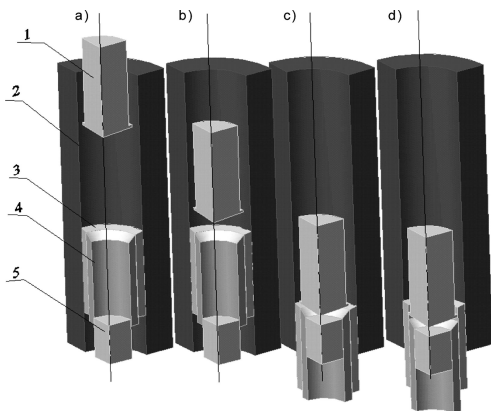

Fig. 5. A model of the tool and the method for complex extrusion of a bottomless sleeve: -description in text

The tool for carrying out the complex bottomless sleeves extrusion process consists of upper punch 1, container 2, cutting sleeve 3, movable ring 4 and knockout 5.

The bottomless sleeve extrusion concept, illustrated in Fig. 5, consists initially in complex (indirect and direct) extrusion. After making a hollow with a stem, the movable ring together with the cutting sleeve move downwards and, similarly as in the method [3,5], a deep bottomed hollow is made. After the appropriate distance between the upper ram and the mandrel has been reached, the cutting sleeve becomes locked and the ram with the ring pass through the cutting sleeve opening. At the same time, the side surface of the upper ram cuts the bottom off and removes it from the container. In the

ram return cycle, the lower mandrel, by acting on the cutting sleeve, removes the product from the container with the movable ring.

In this process, a wholly new functional element that performs the function of the tool cutting the bottom off the body is the cutting sleeve 1, in which pilot ring 2 is mounted. The connection of the cutting sleeve with the movable ring and the lock, and the use of the fixed lock, is shown on the detail in Fig. 6.

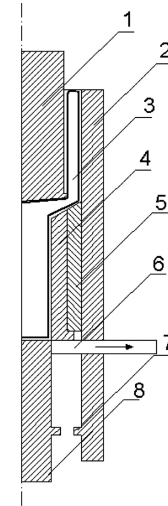

Fig. 6. The scheme of applied solution - the combined of cutting sleeve from movable ring and from blockade as well as the use of immovable blockade: 1-punch, 2-container, 3-perform, 4-movable ring, 5-cutting sleeve, 6-movable blocking, 7-immovable blocking, 8-knock-out

4. Calculation assumptions and numerical modelling

The theoretical analysis of the complex bottomless sleeves extrusion process was made using Forge®, a commercial Finite Element Method-relying software program. Due to the axially symmetrical nature of the processes, the examination was carried out in the plane state of strain.

The Forge®2D program used does not provide the possibility of modelling processes in such a manner that whilst one tool is moving, the other tool could be activated at any moment during the process. Therefore, the modelling utilized *multistep* function, which enables data (results) from the last computational step of Stage I to be transferred to the first computational step of Stage II, owing to which it was possible to take into account the initial process conditions in further computations.

During the numerical simulation of the process of deep sleeve extrusion in a container with a movable ring, the following variable parameters were used:

- movable ring inner diameter, $D_p = 44, 40, 35, 30$ and 20 mm,
- initial stock temperature, $T_0 = 850, 950, 1050$ and 1150 °C; and
- the speed of the working tools (upper and lower rams), $v = 25, 100, 200$ and 300 mm/s.

By varying the ring inner diameters, different metal deformation values were obtained. The ram head diameter was fixed, being equal to $D_{st} = 40$ mm.

To describe the investigation results more clearly, instead of the movable ring inner diameter D_p , ε strain values were used, namely: $\varepsilon = 0.25 \rightarrow D_p = 44$ mm, $\varepsilon = 0.35 \rightarrow D_p = 40$ mm, $\varepsilon = 0.5 \rightarrow D_p = 35$ mm, $\varepsilon = 0.6 \rightarrow D_p = 30$ mm, $\varepsilon = 0.8 \rightarrow D_p = 20$ mm, while calculating the ε from the relationship:

$$\varepsilon = \frac{A_{ws} - A_t}{A_{ws}}$$

where, A_t – the cross-sectional area of the stem formed in the ring channel,

A_{ws} – the cross-sectional area of the preform,

D_p – ring diameter

Figure 7 illustrates the modelling of the process in its respective stages.

The numerical computation has shown, on the example of the cross-sectional temperature distribution, that it is possible to produce bottomless hollows by employing the combined extrusion process. The fields of maximum temperatures in the final process phase occur in the location of the bottom joining the hollow body, whereby the bottom notching process is facilitated owing to the high metal plasticity.

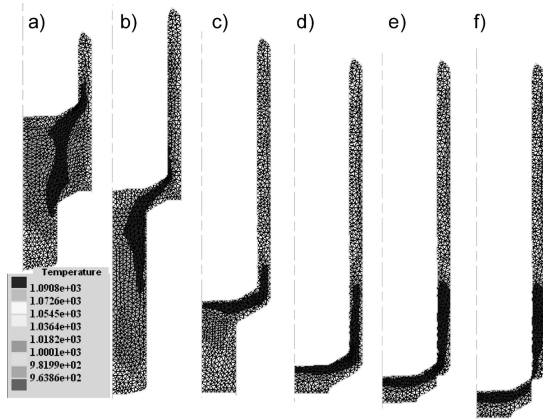

Fig. 7. Modelling of the combined bottomless hollow extrusion process – the temperature distribution: a) stemmed hollow extrusion, b) a stemmed hollow, c) combined extrusion, d) bottomed hollow, e) bottom cut-off, f) bottom removal: for $\varepsilon = 0.6$, $T_0 = 1050^\circ\text{C}$

Figure 8 shows the graphs of the relationship of force versus ram path for the temperature of 1050°C , ram displacement velocity of $v=50$ mm/s and the strain value of $\varepsilon = 0.6$.

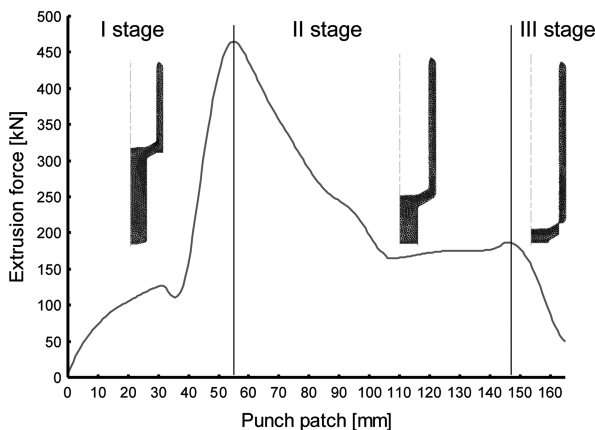

Fig. 8. Diagram of the relationship of extrusion force versus punch path for $T_0 = 1050^\circ\text{C}$, $v=50$ mm/s and $\varepsilon = 0.6$

When examining the graph of the relationship of extrusion force versus punch path it can be noticed that at stage I of the process during stemmed sleeves extrusion the force rapidly increases. This is the effect of the bilateral metal flow and hardening. At stage II of the process, where a bottomed sleeves with a stem is extruded, the force decreases and then stabilizes until the end of stage II. The obtained temperature effect in the sleeves bottom and body connection zone allows the bottom to be cut off with a simultaneous decrease in the force (Fig. 8).

Figure 9 shows the graph of the relationship of extrusion force versus punch path for the combined forward and backward extrusion process examined in study [8].

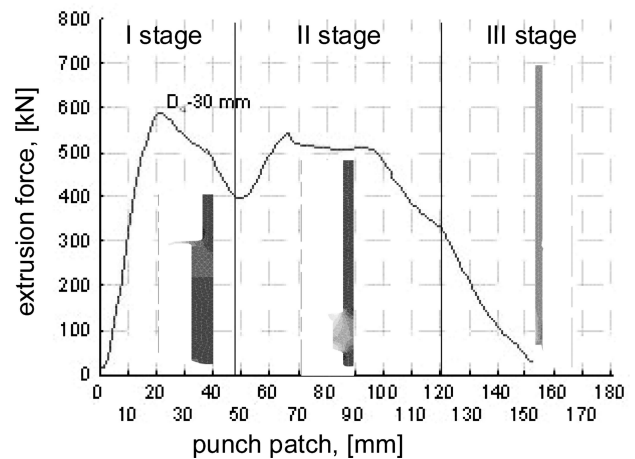

Fig. 9. Diagram of the relationship of extrusion force versus punch path for $T_0 = 1050^\circ\text{C}$, $v = 50$ mm/s and $D_d = 30$. [8]

From the comparison of the graphs (Fig. 8 and Fig. 9) it can be found that the maximum force of stage I and stage II for the process of combined bottomless hollow extrusion in a container with a ring and a cutting sleeve is by approx. 20% smaller compared with the combined forward and backward tube extrusion process. The temperature and velocity parameters and the dimensions of the feedstock and the obtained products were in both cases similar Figure 10. represents the statistical summary of the effect of the preset deformation on the magnitude of the average extrusion force in the process.

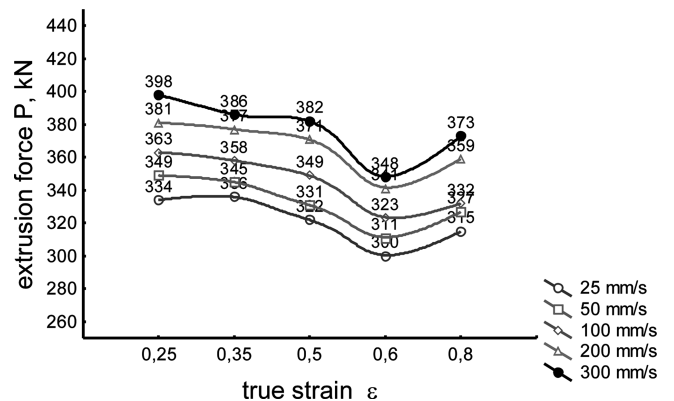

Fig. 10. The effect of the true strain ε on the magnitude of the average extrusion force for: $T_0 = 1050^\circ\text{C}$

The diagram indicates that the optimum strain for all of the velocities examined is $\varepsilon = 0.6$, as the extrusion force for

this deformation variant is the smallest. This is an analogy to the process case examined in studies [2,3].

5. Conclusions

The numerical examination performed in the study can be summarized as follows:

- A new single-operation tube extrusion process has been proposed in the paper.
- In the tool model, an element in the form of a cutting sleeve is proposed, which provides the capability to cut off the hollow bottom at the last stage of the process and then to remove the waste from the container.
- The process is distinguished by lower process parameters compared to the forward and backward tube extrusion process. The extrusion force is, on the average, lower by 20%.
- The numerical modelling has shown that, as a result of high temperatures formed in the hollow bottom and body connection zone due to the high deformation energy, the cutting off process does not cause an increase in force.
- The statistical summary of the results has shown that the use of a strain of $\varepsilon = 0.6$ is optimal for the energy and force parameters of the process.

The next stage of the investigation will include the selection of tool shapes by means of numerical analysis to optimize the waste formed. After achieving the minimum volume, the process will be subjected to experimental testing.

REFERENCES

- [1] W. Libura, Płynięcie metalu w procesie wyciskania. Uczelniane Wydawnictwa Naukowo-Dydaktyczne. Kraków 2008.
- [2] V.V. Dewiatow, J. Michalczyk, J. Rajczyk, Teoretyczne Podstawy i Technologia Procesów Wyciskania. Wydawnictwo Politechniki Częstochowskiej. Częstochowa 2011r. Seria Monografie nr 218.
- [3] J. Michalczyk, The theoretical and experimental comparative analysis of new method of extrusions of deep sleeves and indirect extrusions, Archives Metallurgy and Materials **54**, 3, 663-647 (2009).
- [4] J. Michalczyk, T. Bajor, Study on the influence of temperature, velocity and shape of tools on the combined process of extrusion and broaching of the deep sleeve with the bottom made of the AZ31 alloy, Archives Metallurgy and Materials **56**, 533-541 (2011).
- [5] V.V. Dewiatow, J. Rajczyk, Sposób wytwarzania głębokich cylindrów. Polski Patent nr 345423.
- [6] J. Michalczyk, Sposób wyciskania tulei. Polski Patent nr PL 206467.
- [7] J. Michalczyk, Narzędzie do wytwarzania głębokich cylindrów. Polski Patent nr. 370872.
- [8] J. Michalczyk, Sposób wyciskania tulei przelotowych. Zgłoszenie patentowe nr. 397758.
- [9] J. Tomczak, Z. Pater, Termomechaniczna analiza procesu obciskania obrotowego wielostopniowego wałka drążonego ze stopu tytanu Ti6Al4V. Rudy i Metale Nieżelazne R56 11/2011.
- [10] J. Zasadziński, W. Libura, J. Richert, Minimalizacja parametrów siłowych w procesach wyciskania metali. Rudy i Metale Nieżelazne 3 (2006).
- [11] Z. Pater, A. Gontarz, J. Tomczak, Kształtowanie przez rozpychanie kołnierzy wałów drążonych. Rudy i Metale Nieżelazne R57 2 (2012).
- [12] J. Rajczyk, J. Michalczyk, The Appliance of Numerical and Physical Modelling in the Analysis of the Production Method of Construction Elements and Tools for Material Working". Proceedings of the 3rd International Conference on Contemporary Problems in Architecture and Construction. November 20-24, 2011. Beijing, China. s.2-148 - 2-156.
- [13] J. Rajczyk, J. Michalczyk, Methodology of Modeling Pipes Product Working Illustrated with an Example of a Thermo – Elastic – Plastic Process. Proceedings of the 3rd International Conference on Contemporary Problems in Architecture and Construction. November 20-24, 2011. Beijing, China. s.2-164.

Received: 20 April 2012.