

Wireless communication for control of manipulation systems

KVĚTOSLAV BELDA, VÁCLAV RYCHNOVSKÝ and PAVEL PÍŠA

The paper deals with a novel application of the wireless data communication for a continual control of the distributed manipulation systems. The solution is intended for industrial robotic plants. A considered way of the wireless communication is based on ZigBee protocol. The protocol is tested for a real time bidirectional data communication within a manipulation system. The system consists of several moving manipulation units, several stationary auxiliary units and one control computer. The computer provides the cooperation of all units in the system in relation to the user requirements. The system is controlled by a simple feedback multi-level control realized in MATLAB - Simulink environment. The paper is focused on the realization of the boards of power electronics, transmitters, optical positional sensors, optical gates and their networking in accordance with ZigBee protocol definition. The behavior of the ZigBee is illustrated by several records from real experiments.

Key words: distributed mechatronic system, model-based control, multi-level control, odometry, optical sensors, standard IEEE 802.15.4, ZigBee protocol

1. Introduction

Control systems have to be implemented frequently in heterogeneous applications containing number of components and units. These application elements are also frequently distributed and have different static and dynamic properties [4], [9]. In almost all cases, the modern applications consist of mechanical elements: mechanisms; electromechanical elements: actuators, drive units, contact sensors; and electrical elements: other sensors and indicators usually contactless, controllers, power electronics etc. Altogether, this arrangement represents connection of mechanics and electronics as one general mechatronic system [1], [2].

The key problem is how to establish and maintain communication channels in the systems, which are heterogeneously distributed and have number of various units as

K. Belda is with the Department of Adaptive Systems, Institute of Information Theory and Automation Academy of Sciences of the Czech Republic, public non-university research institution, Pod Vodárenskou věží 4, 182 08 Prague 8, Czech Republic, e-mail: belda@utia.cas.cz. V. Rychnovský and P. Píša are with the Control Engineering Department, Faculty of Electrical Engineering, Czech Technical University in Prague, Karlovo nám. 13, 121 35 Prague 2, Czech Rep.

Received 16.08.2011. Revised 01.03.2012.

illustrated e.g. in Fig. 1. In such cases, the implementation of a conventional communication via wires is limiting and problematic or impossible. The current requirements on the communication are to enable the system to be flexible and modular with possibility to connect other systems or new units in surroundings. Nowadays, the wireless solution is principally applied in simple home automation [6], in simple monitoring operations [12] or in case studies [5], [8], [20], [21]. In those and recent applications, the communication runs predominantly in one specific direction. Transmitted data are processed discontinuously without direct effects on the initial data transmitter or transmitter unit.

This paper investigates the wireless communication standard IEEE 802.15.4 [13] with ZigBee protocol stack extension [7]. It is designed as only one, fully employed bidirectional communication channel for continual feedback control of a specific distributed mechatronic system. The used system in this paper is considered as a model of industrial manipulation systems [3], [5], [8]. The basis of used hardware and software solution in the system was taken from Texas Instruments (TI) Company [15]. This basis is supplemented with interface of position and logical sensors, motors and switch power control, and interface of the control computer.

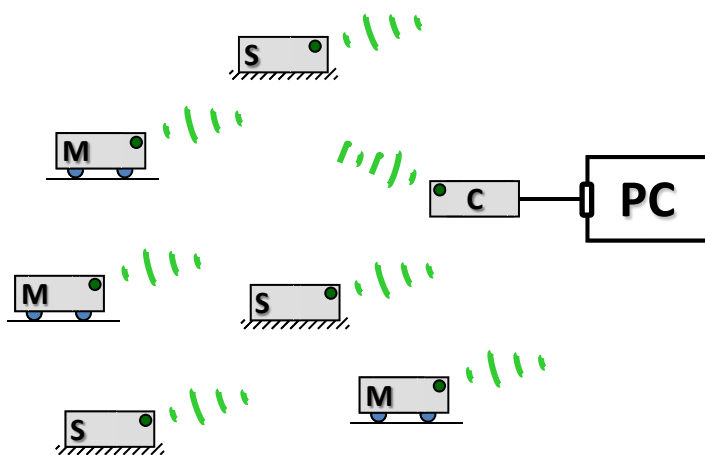

Figure 1. Distributed mechatronic system with several moving units (M) and stationary units (S) with one wireless communication coordinator (C) connected by a standard interface to the control computer (PC)

The paper is organized as follows. The section two introduces ZigBee communication protocol for full bidirectional wireless data transmission as one of advanced communication protocols for the automation. In the section three and four, the design, functions and realization of individual hardware and software components of the wireless communication devices are discussed. The section five demonstrates an application of the wireless communication to a real mechatronic system of several independent moving and stationary units controlled via control computer. The cooperation of all components included in the system is provided by a simple feedback multi-level real-time control.

The section six mentions the main features and possibilities of the presented wireless communication at the application to the feedback control of mechatronic systems.

2. Wireless communication and ZigBee

Wireless communication consists in the data connection of two or more end devices without any mechanical carrier. It can be realized as optical, radio or acoustic communication according to used carrier medium: light waves, radio waves or sound waves. The selection of suitable form is highly-dependent on a given target application.

In case of distributed mechatronic systems, where each unit of the system should be more or less independent and energy self-sufficient, the communication has to be based on some low-power communication technology. It should not load the power supply of appropriate unit and should be self-restarting in case of failure situations.

The mentioned criteria can be accomplished by radio communication based on ZigBee protocol stack. It is used for the solution of the communication task in this paper. ZigBee given by ZigBee Alliance represents promising direction among other radio wireless communication technologies as Bluetooth, WiFi etc. The particular reasons are introduced in the following subsection.

2.1. Features of the ZigBee protocol

ZigBee is a low-cost, low-power, wireless mesh networking proprietary standard of communication protocol. The low cost allows this technology to be widely employed in wireless control and monitoring applications. The low power-usage allows longer life with smaller batteries. Finally, the mesh networking provides high reliability and larger area range. The protocol is able to remain quiescent for long periods without communications and to allow devices to sleep without the requirement for close synchronization [7].

In general, a solution via ZigBee protocol is characterized by high flexibility and modularity. There are theoretically no limits on the number of networked units (end devices) in the system. A limiting factor is only a time-consumption management of the control computer (if necessary) and naturally the data rate for one transmission (nominal rate is 250Kbps at 2.4GHz [12]). Otherwise, the communication is not generally limited. It can flow simultaneously for more end devices as necessary.

The ZigBee protocol is intended for the use in embedded applications having low data rates and requiring low power consumption. A ZigBee's focus is to define a general-purpose, inexpensive, self-organizing mesh network that can be used for industrial control, embedded sensing, medical data collection, smoke and intruder warning, building automation, home automation, etc. The resulting network may use local power-supply units to be independent of the central supply. ZigBee has very low duty cycle, static and dynamic star, mesh or cluster tree networks with up to 65k nodes in one network, with low latency available.

2.2. ZigBee network

Individual devices in the network called nodes can play a role of ZigBee Coordinator, Router or End Device. ZigBee network model is shown in Fig. 2. Whole figure represents cluster-tree network including one router as coordinator, a group of separate routers representing mesh network and two indicated areas with several end devices representing star networks [1].

The role of the coordinator is to set up a network, transmit network beacons (synchronizing signals), manage the nodes and store their information and route messages between paired nodes. It typically operates in the receiving mode.

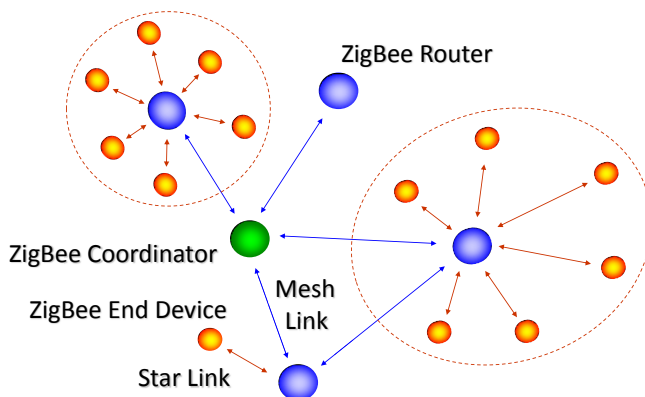

Figure 2. ZigBee network model (network topology)

The role of the rest of the network nodes, designed for battery powered or high energy savings consists in searching for available networks, transferring data from their applications as necessary, furthermore determining whether data is pending, and requesting data from the network coordinator. These individual nodes can sleep for extended periods.

2.3. ZigBee protocol stack (Z-Stack)

Software solution of the ZigBee communication from TI Company is in software pack "Z-Stack". This pack includes the implementation of ZigBee protocol layers and layers working with peripherals and modules of communication microcontroller. Furthermore, there is a simple implementation of Operational System Abstraction Layer (OSAL) in the Z-Stack. From ZigBee protocol definition point of view, there are some layers directly implemented in Z-Stack TI library [22].

Layer description corresponds to the standard IEEE 802.15.4 - 2006 (OSI Reference Model, [13]).

3. Mechatronic system: component analysis

This section deals with an implementation of the ZigBee communication, theoretically described in the previous section, in a real laboratory model of distributed mechatronic system intended for manipulation operations. The implementation of the communication will be described partly in relation to the used hardware components and also to the function of the distributed system and partly in view of the software with focus on data communication scenario both in a frame of the ZigBee wireless network and communication interfaces of individual system components.

The mechatronic system (Fig. 3) consists of several distributed moving units and stationary units. Moving units provide discontinued manipulative operations and stationary units serve as monitoring and utility interface. Both moving and stationary units should be independent of other units (autonomous of others) in all respects, i.e. they should be self-controlling, energy self-sufficient etc. The units are equipped with communication transceiver (transmitter and receiver - all in one). Moving units are driven by their own direct current (DC) motors as unit actuators and contain electro-optical positional sensors.

The motors and positional sensors (let us say peripheries) are connected with transceivers to the ZigBee communication network.

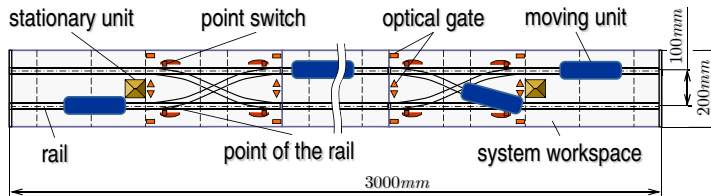

Figure 3. Schema of mechatronic manipulation system

3.1. Hardware components

From the network topology point of view (Fig. 2), the wireless communication in the considered mechatronic system is realized as one star network with a one main node working as a ZigBee router and holding also the ZigBee coordinator's function. This main node is a gateway for control computer, which provides real control of the system units. Individual moving and stationary units represent ZigBee End Devices (e.g. see Fig. 4).

The ZigBee Coordinator is connected to the control computer via USB interface. From the computer point of view, the ZigBee communication serves the computer as a very flexibly reconfigurable Input - Output interface with variable number of various inputs and outputs.



Figure 4. Moving unit as one of the end devices

Main elements of the hardware are elements, which are able to provide the communication according to IEEE 802.15.4 standard and its extension defined by Zig-Bee Alliance. In presented solution, TI Development Kit CC2520DK is used [15]. On its basis, the suitable board for moving and stationary units was developed and realized. The main limit was an available place in the units for the board installation ($20 \times 20 \times 70\text{mm}$). The Fig. 5 shows trial board hardware realization.

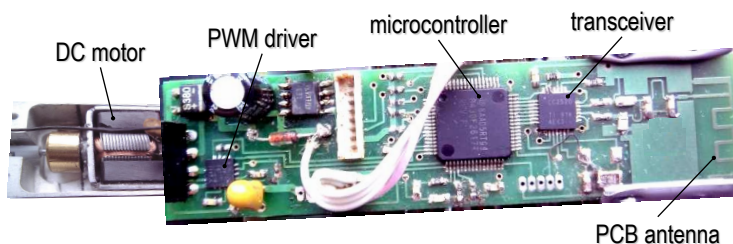

Figure 5. The board with communication transceiver and power-drive control

The circuit of the board in Fig. 5 contains microcontroller MSP430F2618 [16], transceiver CC2520 (compatible with standard IEEE 802.15.4) [14] and Pulse Width Modulation (PWM) power driver DRV8800 [17] of DC motor. On opposite side, there is a Printed Circuit Board antenna (PCB antenna, monopole) for the transceiver. This circuit followed from the development kit CC2520DK is moderately adapted partly due to dimension requirements and partly due to attached peripherals: DC motor, optical position sensor, infrared optical gate, point switch etc.

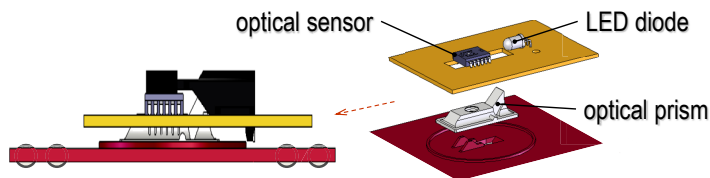

Figure 6. Optical sensor unit for position monitoring

Fig. 6 shows a vertical assembling disposition of optical sensor PAN3401 [10] including other necessary optical parts. In the Fig. 7, there is an optical infrared gate circuit scheme (emit. diode TSAL6100 [18] and receiver TSOP31236 [19]).

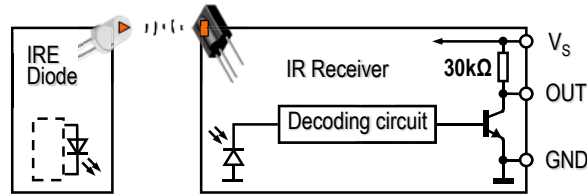

Figure 7. Circuit scheme of optical gate

3.2. Software components

As was mentioned, the software components follow from TI software pack "Z-Stack". The connection of the main node of the wireless network (combined router & coordinator), in fact connection of the transceiver CC2520, and control computer is realized in Hardware Abstraction Layer (HAL) as well as connection of AD converter module for PWM etc. However, real data processing from/for attached peripheries (positional sensor; PWM generation; point-switch signals; signal for infrared optical gates; reading the signal from these gates; USB communication i.e. coding and decoding messages), is provided in the Application Layer (APL) by defined user application. Thus, standard TI Z-Stack was modified only for communication with optical positional sensor, PWM controller and serial communication with control computer. Further utility software is in the control computer. It provides serial interface between the coordinator of the communication and user application in MATLAB-Simulink environment.

4. Scenario of data communication

For the communication, crucial moment is a transmission of the packet with a message from the main coordination network node. The packet contains specific target address (generally 0xFFFF; see Fig. 8), which implies, that all units (nodes, end-devices) involved in the network will process the packet message. The relevant message has to be decoded according to node/unit number (end-device number); thus according to attached periphery (DC motor, point switch etc.) and supplemented by call message, which warns the specific unit to send out the message with answer. Answering message has target address of the coordinate (generally 0x0000).

All units send out gradually their data back to the coordinator. After fixed time cycle, the coordinator transmits again for all units and receives further answers. Furthermore, the coordinator, i.e. the main network node, communicates independently (asynchronously) with control computer. The main node receives the messages in defined

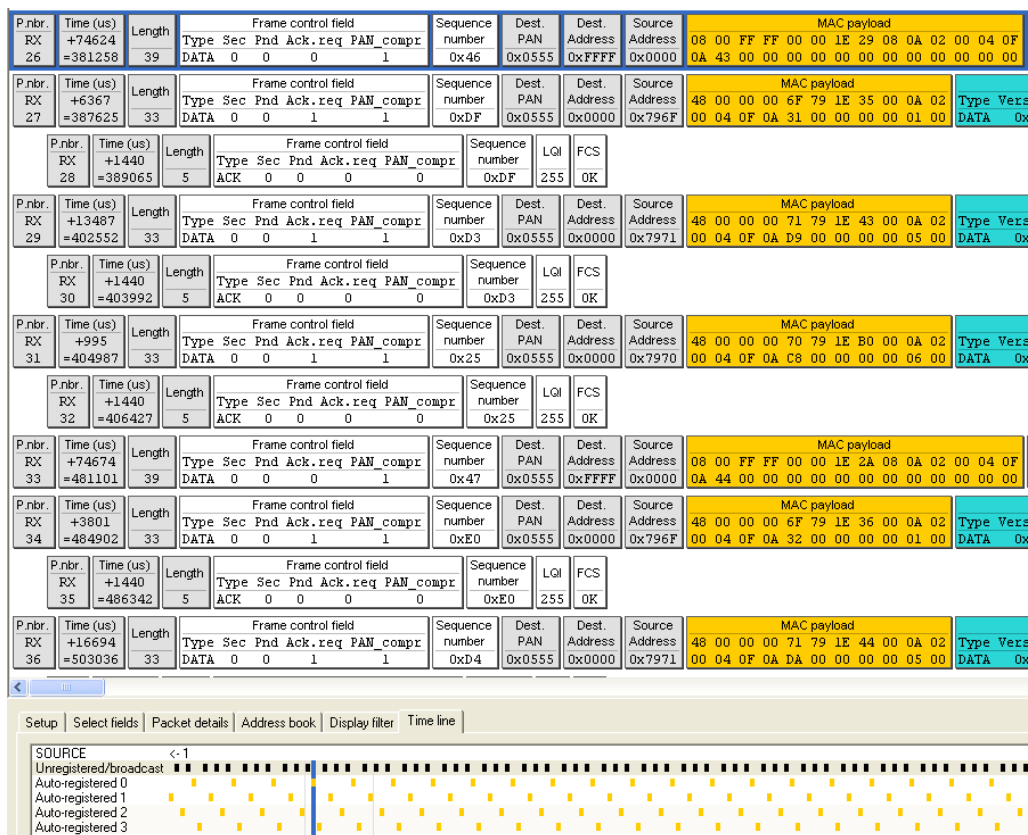

Figure 8. ZigBee packets (framed line = one transmission of the coordinator)

form, from which decodes data for individual units - end devices. The coordinate node transmits the data in next time cycle. The main node answers immediately to the control computer and sends it the latest data generated by units in previous time cycle.

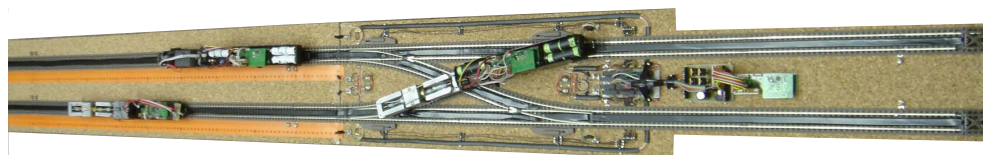

Figure 9. Real laboratory model of mechatronic manipulation system

5. Hardware in the Loop: real runs

The hardware i.e. all components or units forming the mechatronic system (Fig. 9) are moving units with PWM control and optical position sensor; stationary units with point-switches and optical gates. All these components are connected in the loop, which is closed in the control computer. The computer provides regularly data exchange via ZigBee coordinator as an access point to the network, generates control commands and provides processing and visualization of acquired data from system units. The control algorithm (data processing and generation of new appropriate values of control actions) is realized by means of MATLAB – Simulink environment and their real-time software extensions for the rapid prototyping: Simulink Coder (Real-Time Workshop) and Real-Time Windows Target.

5.1. Working conditions

The conditions follow from sampling period of the control loop. It is defined according to moving unit dynamics and expected time-variability of the user or technology requirements. Here, the rated sampling $T_s = 0.1s$ is used. It determines processing of the sensed positions of all moving units in the net; set of the unit way i.e. point switches; decoding monitoring signals from optical gates. The position processing includes on-line calibration of the transformation coefficient, which converts increments of the positional sensor to real position in *mm*.

The calibration is based on repeated counting of positional increments for known distance between two optical gates and calculating relevant conversion ratio: position versus number of increments. The gates correct the topical position. It is necessary due to low accuracy (repeatability) of the optical incremental positional sensors and changing their sensitivity at different surface and electrical conditions. Thus, the gates represent specific absolute marks with known absolute position. They provide the incremental measurement to be meaningful for continual unit location. The reached accuracy of the positional measurements is approximately $\pm 5 - 10mm$ on $1000mm$ (total longitudinal distance is $3000mm$; see scheme of the system in Fig. 3).

5.2. Experiments

Real hardware-in-the-loop experiments were realized with Simulink model (Fig. 10). As a control algorithm, the simple multi-level feedback control was used. It represents bang-bang (on-off) control [11] in multiple mode. The algorithm changes control actions discretely relative to a topical position (positional feedback).

The control actions may have the five values: $[-u_{max}, -u_{min}, 0, u_{min}, u_{max}]$, where u_{max} is a maximum motor excitation and u_{min} is a reduced excitation before turns. Control process sample (Fig. 11) represents selected automatic cyclic motion of one moving unit along the rail of the mechatronic system (Fig. 9).

The mechatronic system itself is connected within the Simulink model via Standard Devices Serial Port - Stream Output (PWM data) and Input (Sensor data) Simulink

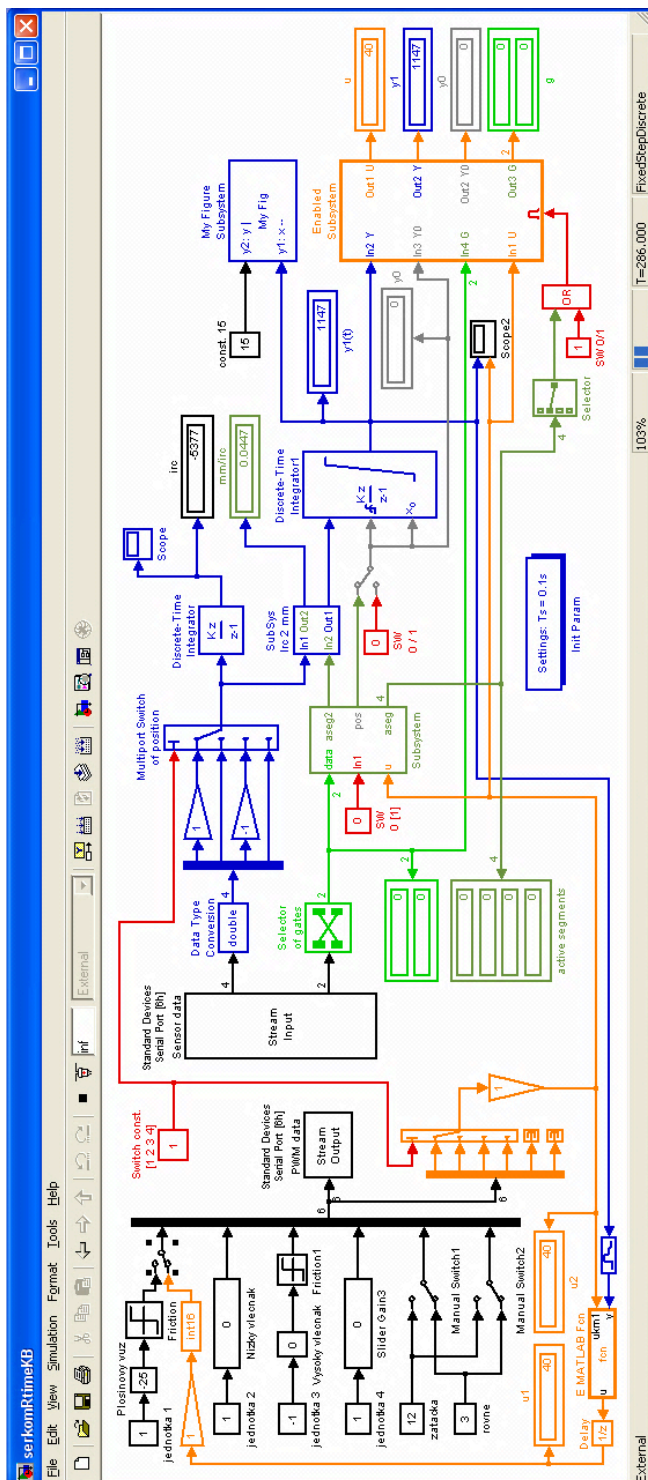

Figure 10. Screen shot of the real-time running Simulink model in the computer

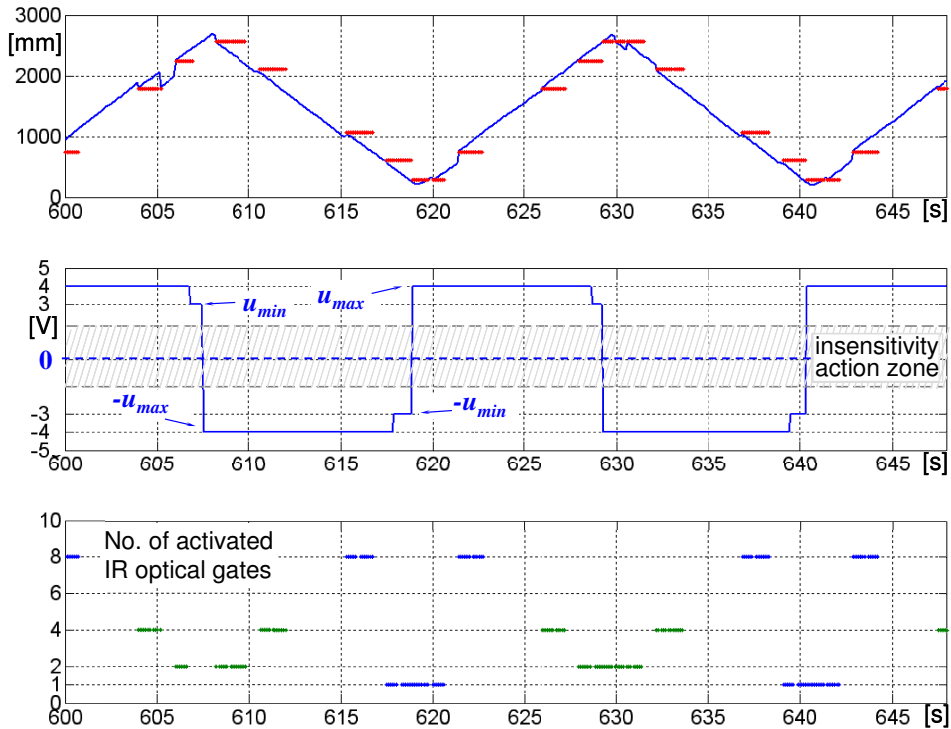

Figure 11. Control process of one moving unit: time histories of position (on the top), control actions (in the middle), activations of optical gates (at the bottom)

blocks. These Input - Output blocks provide communication with serial interface of the control computer.

The control loop starts with a Stream Input block. It provides access to the positional increments and gate signals. Then, there are several transformation blocks for the position calibration and logical blocks for the optical gates. All output signals lead to Discrete-Time Integrator block. It has two extra external ports: reset and initial condition. The block integrates the position increments of the moving units. It may be restarted (reinitialized) just by mentioned additional input ports. The position is processed in a user defined block 'E MATLAB Fcn' (left side bottom corner of the Simulink model), in which the appropriate values of control actions are selected relative to topical unit position on the rails. The values are passed to the 'Stream Output' block towards the wireless interface of the mechatronic system, real hardware. The loop is closed this way.

The data records selected from the experiments are shown in Fig. 11. The reset of the integrator is indicated by short horizontal lines, which correspond to the activation of optical gates. Passing the gate by any moving unit causes signal in the optical circuit (Fig. 7). Individual levels (i.e. 1, 2, 4, 8) correspond to the code of the activated gates. The data records show occasional failures in position estimate. It can be caused by imperfect

surface scanned by optical sensor PAN3401. The ZigBee communication had no failures in the data transmission. They may occurred, if the transmitted signal is low or is blocked by some obstacle and signal reflection is not feasible.

6. Conclusion

This paper deals with the wireless communication based on ZigBee networking protocol. The aim of the investigation, development and experiments was an evaluation of possibilities of wireless communication as full-value data channel for advanced feedback control approaches. The experiments demonstrate ZigBee as suitable alternative to the conventional wire solutions. It is especially important for feedback control of the systems with distributed end devices, where number of the conventional cables (wires) limits the system motion and modularity.

References

- [1] K. BELDA and V. RYCHNOVSKÝ: Wireless control communication for mechatronic systems. *Proc. Workshop on Systems and Control*, Veszprém, University of Pannonia, (2010), 68-73.
- [2] K. BELDA, V. RYCHNOVSKÝ and P. PÍŠA: Distributed wireless mechatronic system operated from MATLAB-Simulink environment. *Proc. 19th Annual Conf. Technical Computing*, Prague, (2011) 1-8.
- [3] N. DANIŠOVA, K. VELÍŠEK and P. KOŠT'ÁL: Automated tool changing system in the intelligent manufacturing and assembly cell. *Int. Symp. on Computing, Communication, and Control*, 2009, Singapore), **1** (2011), 1-7.
- [4] H. TSUKUNE ET. AL.: Modular manufacturing. *J. of Intelligent Manufacturing*, **4**(2), (1993), 163-181.
- [5] M. HVILSHØJ, S. BØGH, O.S. NIELSEN and O. MADSEN: Autonomous industrial mobile manipulation (AIMM) – past, present and future. *Industrial Robot: An Int. J.*, **39**(2), (2012), 1-24.
- [6] MING-HUI JIN, CHIH-HAO YU, HUNG-REN LAI and MING-WHEI FENG: Zig-bee positioning system for smart home application. *Lecture Notes in Computer Science*. **4743** (2007), 183-192.
- [7] P. KINNEY: ZigBee technology: Wireless control that simply works. *Proc. Communications Design Conf.*, San Francisco, CA, USA, (2003), 1-21.

-
- [8] K. KOUMPIS, L.H.M. ANDERSSON and M. JOHANSSON: Wireless industrial control and monitoring beyond cable replacement. *PROFIBUS Int. Conf.*, Coombe Abbey, Warwickshire, UK, (2005) 1-7.
- [9] S. MEKID, P. PRUSCHEK and J. HERNANDEZ: Beyond intelligent manufacturing: A new generation of flexible intelligent NC machines. *Mechanism and Machine Theory*, **44** (2009), 466-476.
- [10] PIXART IMAGING INC.: PAN3401 PS/2 Optical mouse single chip. (Datasheet), 2008.
- [11] S. ROLEWICZ: Functional analysis and control theory: Linear systems. Mathematics and its Applications, D. Reidel Publishing Co., 1987.
- [12] A. SHEIKH and D. AL-MOELLAM: Wireless networking for monitoring and control system of a steel plant. *Wireless Personal Communications* (2011), 1–18.
- [13] IEEE COMPUTER SOCIETY: Specifications for low-rate wireless personal area networks (WPANs) IEEE Std 802.15.4. Part 15.4: Wireless Medium Access Control & Physical Layer, IEEE, Inc., 2006.
- [14] TEXAS INSTRUMENTS: 2.4 GHz IEEE 802.15.4/ZigBee RF Transceiver (Datasheet), 2007.
- [15] TEXAS INSTRUMENTS: CC2520 Development Kit (User's Guide), 2007.
- [16] TEXAS INSTRUMENTS: MSP430F241x-F261x Mixed Signal Microcontroller Rev. F, (Datasheet), 2009.
- [17] TEXAS INSTRUMENTS: DMOS Full-Bridge Motor Drivers Rev. D (Datasheet), 2010.
- [18] VISHAY ELECTRONIC GMBH: Tsal6100, High Power Infrared Emitting Diode (Datasheet), 2009.
- [19] VISHAY ELECTRONIC GMBH: TSOP312., TSOP314., IR Receiver Modules for Remote Control Systems (Datasheet), 2009.
- [20] S. YEH, CH. HSU, T.CH. SHIH, J.P. HSIAO and P.L. HSU: Remote control realization of distributed rescue robots via the wireless network. *SICE Annual Int. Conf.*, (2008), 2928-2932.
- [21] LI ZHENG: ZigBee wireless sensor network in industrial applications. *SICE-ICASE Int. Joint Conf.*, (2006), 1067-1070.
- [22] ZIGBEE ALLIANCE: ZigBee specification, ZigBee document 053474r17, 2008.