

T. WĘGRZYN\*, R. WIESZAŁA\*

## SIGNIFICANT ALLOY ELEMENTS IN WELDED STEEL STRUCTURES OF CAR BODY

### WAŻNIEJSZE PIERWIASTKI STOPOWE W SPAWANYCH STALOWYCH KONSTRUKCJACH POJAZDÓW

Structure, safety and exploitation conditions of welding steel in car body depend on many factors. The main role of that conditions is connected with car body material, welding technology, state of stress and temperature. Because of that, a good selection of steel and welding method is very important for proper steel structure. Low alloy steel is used for car body structure, very often with small amount of carbon and the amount of alloy elements such as Ni, Mn, Mo, Cr and V in car body and welded joints. Depending on the kind of steel which is used, a proper welding method and adequate filler materials should be applied. The present paper describes the influence of Mn, Ni, Mo, Cr, V in WMD (Weld Metal Deposit) on the behaviour of steel structure especially for low temperature service.

*Keywords:* alloy elements, weld, impact toughness, fatigue test

Struktura, bezpieczeństwo i warunki spawania stali karoserii samochodowych są zależne od wielu czynników. Główną rolę odgrywają warunki związane z materiałem, metodą spawania, stanem naprężenia oraz temperaturą. Jednakże za najistotniejszy czynnik uważany jest odpowiedni dobór metody spawania. Do konstrukcji karoserii używana jest stal niskostopowa, bardzo często z małą ilością węgla i pierwiastków stopowych, takich jak Ni, Mn, Mo, Cr i V. W zależności od rodzaju stali należy użyć właściwej metody spawania oraz odpowiednich materiałów dodatkowych. W niniejszej pracy przedstawiono wyniki badań wpływu Mn, Ni, Mo, Cr, V w stopiwie (WMD) na zachowanie konstrukcji stalowej szczególnie podczas niskich temperatur pracy.

### 1. Introduction

The influence of manganese, nickel, molybdenum, chromium, vanadium, nitrogen and oxygen contents in weld metal deposit (WMD) on impact properties was well analysed in the last 15 years [1-8]. Chromium, vanadium and nitrogen are regarded as the negative element on impact toughness properties of low alloy basic electrode steel welds in sub zero temperature. On the other hand nickel and molybdenum have the positive influence on impact properties. Authors of the main publications [3-6] present that nickel content should not exceed 3%, manganese should not exceed 1%, chromium content should not exceed 0,7%, molybdenum content should not exceed 0,6% vanadium content should not exceed 0,3% in car body steel structure[3-6]. Authors of other publications emphasise the great role of oxygen and nitrogen in car body welded joints[4, 5]. Nitrogen content in low alloy weld metal deposit should not be greater than 80ppm, and the oxygen amount should not be greater

than 600ppm. The amount of nitrogen in low-alloy steel is mainly limited, however some authors [2, 3, 7] assume that some nitride inclusions such as TiN, BN, AlN could have a positive influence on the formation of acicular ferrite in welds. The amount of oxygen in low-alloy steel should also be limited below 600ppm, because higher amount of O has negative influence on acicular ferrite formation in welded joints [4, 5]. Welding parameters, metallographic structure and chemical composition of weld metal deposit are regarded as the important factors influencing the impact toughness of deposits [7-8]. The influence of the variable amounts of nickel, molybdenum, chromium, vanadium on impact properties of low alloy weld metal deposit was described in the paper.

### 2. Experimental procedure

Basic electrodes prepared in experimental way were used to assess the effect of nickel, molybdenum, chromium, vanadium on mechanical properties of deposited

\* SILESIAAN UNIVERSITY OF TECHNOLOGY, FACULTY OF TRANSPORT, 40-019 KATOWICE, 8 KRASIŃSKIEGO STR., POLAND

metals. The electrode contained constant or variable proportions of the components in powder form presented in Table 1. The principal diameter of the electrodes was 4mm. The standard current was 180A, and the voltage was 22V. A typical weld metal deposited had following chemical composition showed in Table 2.

Composition of a basic electrode

technical grade chalk	30%
fluorite	20%
rutile	4%
quartzite	3%
ferrosilicon (45%Si)	6%
ferromanganese (80%Mn)	4%
ferrotitanium (20%Ti)	2%
iron powder	31%

TABLE 1

Composition of typical weld metal

C	0.08%
Mn	0.8%
Si	0.37%
P	0.018%
S	0.019%

TABLE 2

The oxygen content was in range from 340 to 470ppm, and the nitrogen content was in range from 70 up to 85ppm. The acicular ferrite content in weld metal deposit was above 50%. This principal composition was modified by separate additions of ferroalloys (Table 3). A variation in the manganese, nickel, molybdenum, chromium, vanadium amount in the deposited metal was analysed in the range showed in Table 4.

TABLE 3

Ferroalloys in electrode coating

ferromanganese (80%Mn)	up to 5% (at the expense of iron powder)
ferronickel powder	up to 4% (at the expense of iron powder)
ferrochromium powder	up to 2% (at the expense of iron powder)
ferrovanadium powder	up to 1.5% (at the expense of iron powder)
ferromolybdenum powder	up to 1.5% (at the expense of iron powder)
ferronickel powder	up to 6.5% (at the expense of iron powder)

TABLE 4

Varied alloy elements in WMD

Mn	0.8% up to 2.4%
Ni	1% up to 3%
Mo	0.2% up to 0.6%
Cr	0.2% up to 0.6%
V	0.05% up to 0.15%

Further on, a cycle of fatigue tests was conducted [9]. Fatigue tests were conducted on a machine for rotation bending MUJ 6000. The basis for fatigue tests for welded joints a value of  $2 \cdot 10^6$  cycles was assumed. Each time five samples were tested for a given level of stress. After a given stress was increased above the fatigue resistance, four additional stress levels were analysed for each method in order to achieve approximately steady layout of the points.

Tested deposited metal was prepared in accordance with the norm PN EN 87/M 69772 [10]. Samples without notch were bored from the prepared deposited metal according to the norm PN EN 76/H 04326 [11]. The shape and size of a sample was presented in Fig. 1.

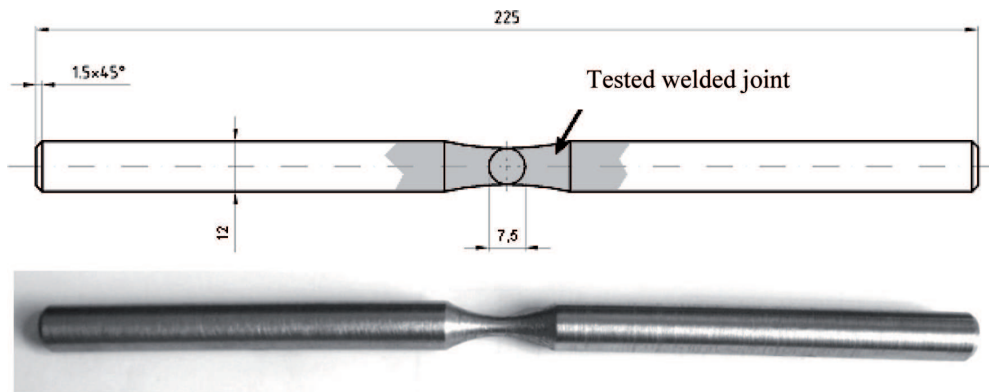

Fig. 1. Size and shape of a sample used in fatigue tests

After conducting a series of tests for a given batch of samples, the results were statistically analysed, then the linear regression equation was marked and the value of fatigue resistance was calculated. Next, the Wöhler graphs were prepared for the fatigue resistance. The aim of this test was to define the fatigue resistance of the deposited metal in order to achieve the data concerning the operating properties of the weld. To make the analysis more thorough metallographic micro-section and factographic tests with the use of scanning microscope were also conducted.

### 3. Results and discussion

After the welding process with the use of basic coated electrodes there was gettable weld metal deposit containing variable amounts of tested elements (Mn, Cr, Mo, V, Ni). After that the chemical analysis, micrograph tests and Charpy V impact test of the deposited metal were carried out. The Charpy tests were done mainly at +20°C and -40°C on 5 specimens having been extracted from each weld metal. The impact toughness results are given in Figures 2-6.

It is possible to deduce after the analysis of Fig. 2 that impact toughness of weld metal deposit is not strongly affected by the amount of manganese. Absorbed

energy in terms of the amount of vanadium in weld metal deposit is shown in Fig. 3. Analysing figure 3 it is possible to deduce that impact toughness of weld metal deposit is much more affected by the amount of vanadium than manganese. Absorbed energy in terms of the amount of chromium in weld metal deposit is shown in Fig. 4.

Analysing Fig. 3 it is possible to observe that impact toughness of weld metal deposit is also much more affected by the amount of chromium than manganese. Absorbed energy in terms of the amount of nickel in weld metal deposit is shown in Fig. 5.

Analysing Fig. 5 it is possible to deduce that impact toughness of weld metal deposit is very positively affected by the amount of nickel. Absorbed energy in terms of the amount of molybdenum in weld metal deposit is shown in Fig. 6.

Analysing Fig. 6 it is possible to observe that impact toughness of weld metal deposit is also very positively affected by the amount of molybdenum. Based upon the values observed in Figs. 4, 5 it was deduced that only Mo and Ni are elements which positively influence the impact toughness of WMD. Nevertheless, deposits with optimal impact toughness properties (Figs.: 2-6) of each deposit were further tested: 0.8% Mn (Fig. 2), 0.05% V (Fig. 3), 0.2% Cr (Fig. 4), 2% Ni (Fig. 5), 0.4% Mo (Fig. 6).

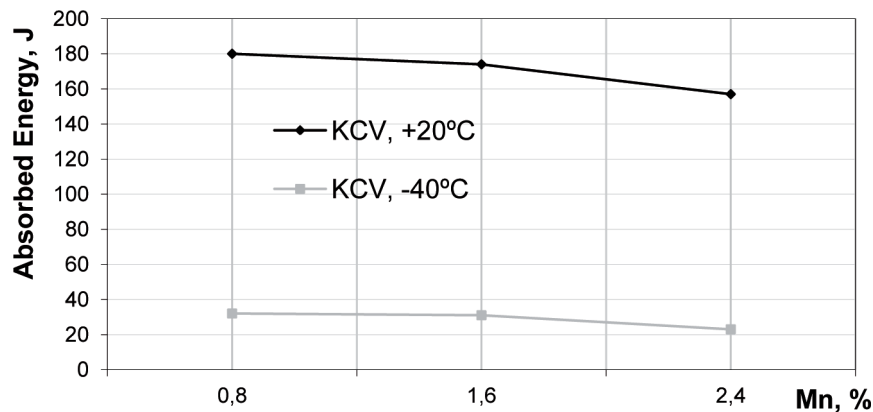

Fig. 2. Relations between the amount of Mn in WMD and the impact toughness of WMD

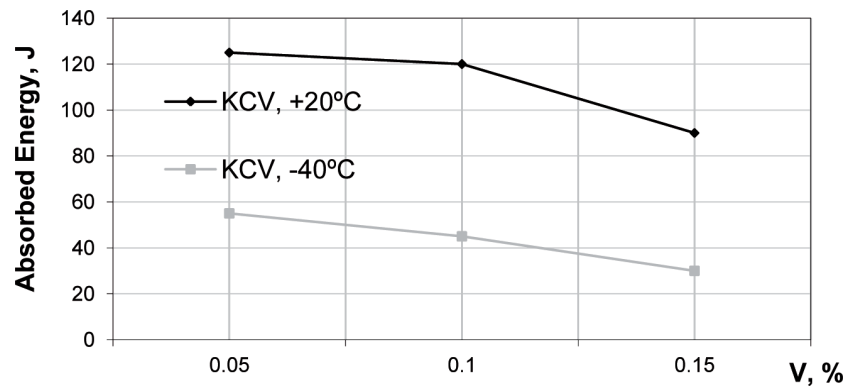

Fig. 3. Relations between the amount of V in WMD and the impact toughness of WMD

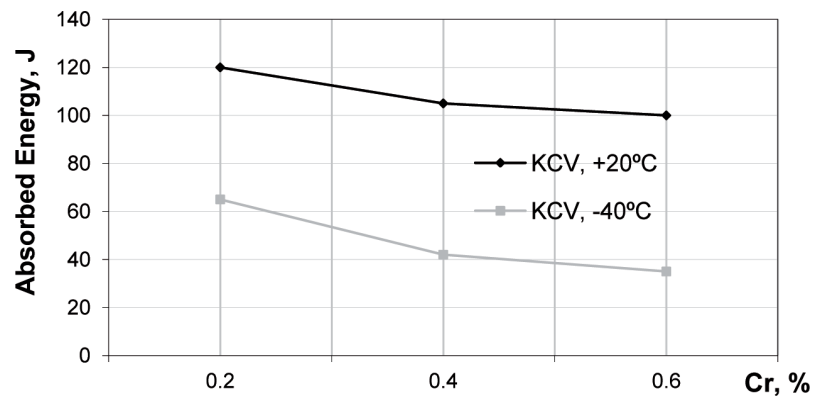

Fig. 4. Relations between the amount of Cr in WMD and the impact toughness of WMD

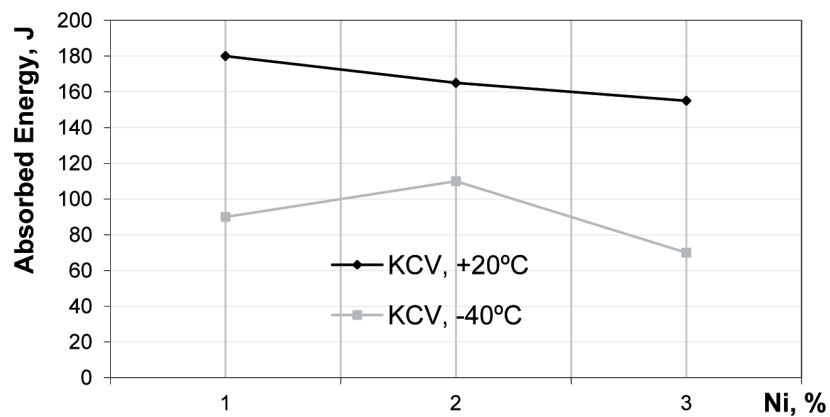

Fig. 5. Relations between the amount of Ni in WMD and the impact toughness of WMD

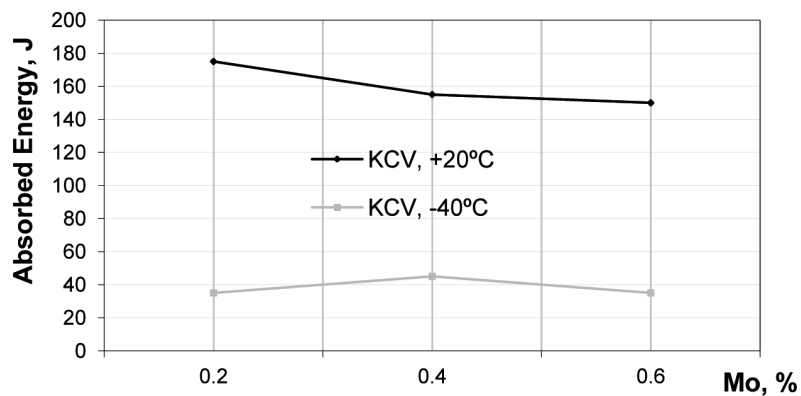

Fig. 6. Relations between the amount of Mo in WMD and the impact toughness of WMD

In automotive welded structures there are two general types of tests performed: impact and fatigue. The second type of the mentioned tests focuses on the nominal stress required to cause a fatigue failure after a specified number of cycles. The test results can be presented as a plot of stress (S) against the number of cycles to failure (N), which is known as an S-N curve. Fatigue tests were performed for five different deposits with varied amount of alloy elements (Mn, V, Cr, Mo, Ni). The test samples

were prepared according to the norm PN EN 87/M 69772 [10]. Results of fatigue tests are presented in Figs. 7-11.

Analyzing Figs. 7-11 it is possible to deduce that also in those tests the deposits with the amount of Ni and Mo must be treated as beneficial. The fracture surface of weld metal deposit with different amount of nickel (representing WMD with higher mechanical properties) and vanadium, nickel (representing WMD with lower mechanical properties), was analysed as well.

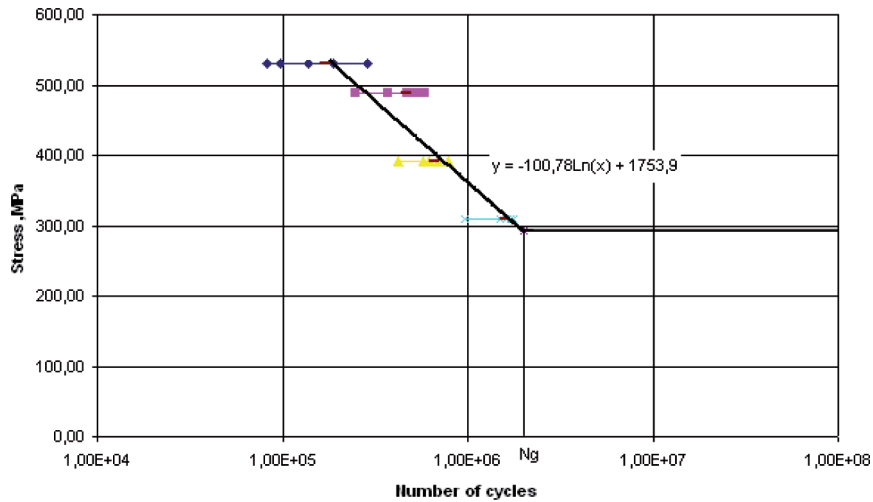

Fig. 7. S-N Curve for WMD with 0.6% Cr

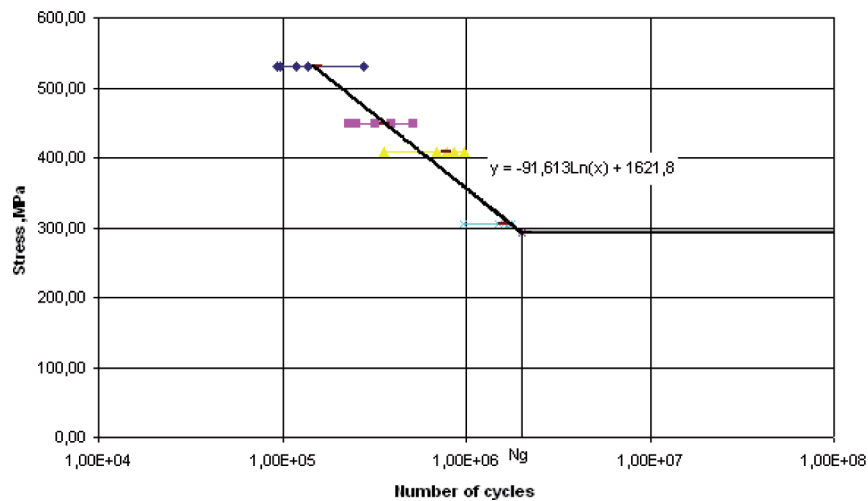

Fig. 8. S-N Curve for WMD with 0.2% V



Acicular ferrite and M-A(martensite-austenite) phases (self-tempered martensite, upper and lower bainite, retained austenite, carbides) were analysed and counted for each weld metal deposit. Amount of AF (acicular ferrite) and M-A phases were on the similar level in deposits as Ni and Mo, also for deposits with V, Mn and Cr there were observed rather similar structure. Results of deposits with different structure (corresponding with higher or smaller mechanical properties of WMD) are shown in Figs. 12, 13.

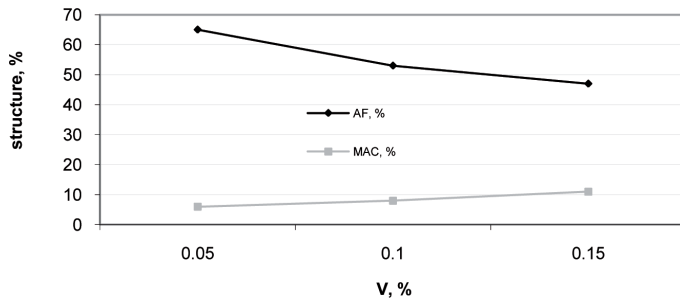

Fig. 12. Metallographic structure with V in WMD

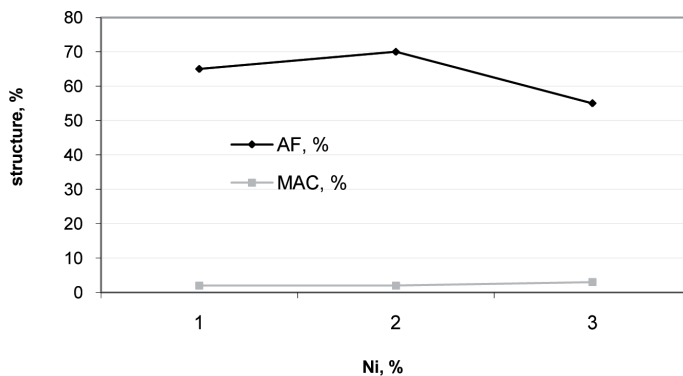

Fig. 13. Metallographic structure with Ni in WMD

It was deduced that nickel (and molybdenum) have positive influence on the structure. That relation was firstly observed in impact toughness tests. Nickel and molybdenum could be treated as the positive elements influencing impact toughness because of higher amount of acicular ferrite and smaller amount of phases MAC (martensite, austenite, carbides). Chromium and vanadium could be treated as the negative elements influencing impact toughness and structure of WMD. Manganese could be rather treated as a neutral element influencing impact toughness of WMD. Additional fracture surface observation was done using a scanning electron microscope. The fracture of weld metal deposit which included 2% Ni (representing WMD with higher mechanical properties) is presented in Fig. 14, and the fracture of weld metal deposit which included 0.6% Cr (representing WMD with smaller mechanical properties) is presented in Fig. 15.

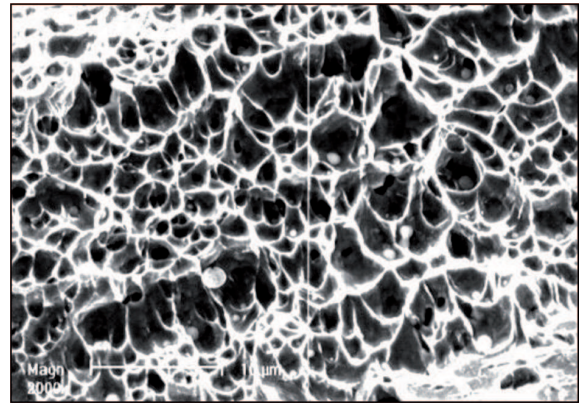

Fig. 14. Fracture surface of weld metal deposit. (magnification 2000 $\times$ ). The photo presents the 2% content of Ni in the weld

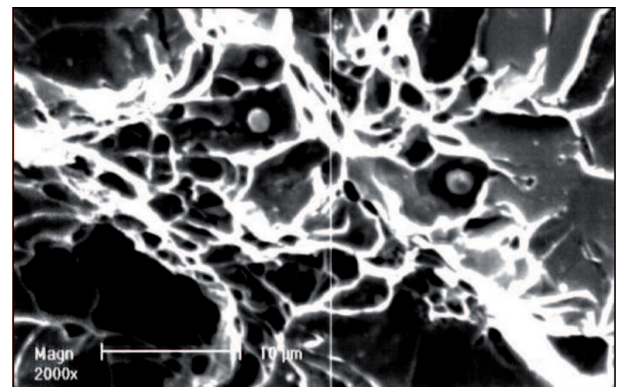

Fig. 15. Fracture surface of weld metal deposit. (magnification 2000 $\times$ ). The photo presents the 0.6% content of Cr in the weld

The fracture surface is ductile, because of the beneficial influence of nickel on the deposit structure. After microscope observations it was determined that the amount of nickel (or molybdenum) has a great influence on the character of fracture surface. The fracture surface was ductile also for WMD containing Mo in it. The character of fracture surface changed from ductile to much brittle in terms of the increase of the amount of vanadium (or chromium). The typical fracture of metal weld deposit containing 0.6% of Cr is presented in Fig. 15.

The fracture surface is less ductile, because of the higher amount of chromium in deposit. The surface was also brittle for WMD containing V. After microscope observations it was determined that the amount of chromium (or vanadium) has also a great influence on the character of fracture surface. The character of fracture surface changed from ductile to much brittle in terms of the increase of the amount of chromium.

#### 4. Conclusions

Influence of Ni, Cr, Mo, V and Mn as an important alloy elements in car body structures were tested. Role

of them is not the same. On the basis of investigation it is possible to deduce that:

1. Nickel and molybdenum are positive elements in low alloy weld metal deposits.

2. Chromium and vanadium cannot be treated as positive elements in low alloy weld metal deposits.

3. Manganese could be treated rather as a neutral element influencing impact toughness properties.

4. Operating properties of the tested welded joints have shown that the additive of alloys Cr and V influence the fatigue resistance of tested welded joint negatively, whereas additives of alloys Ni and Mo influence the fatigue resistance positively.

5. It was observed that manganese is a neutral element. Its presence does not influence the operating properties of the tested welded joint.

#### REFERENCES

- [1] P. J u d s o n, D. M c K e o w n, Advances in the control of weld metal toughness, Offshore welded structures proceedings, London, **2**, (1982).
- [2] J.F. L a n c a s t e r, Physics of Welding, Pergamon Press 1986.
- [3] A. G r u s z c z y k, J. G ó r k a, Heterogeneity of chemical composition and the structure of welded joints and padding welded joints. Welding Technology Review. No 3, 3-6 (2010).
- [4] T. W ę g r z y n, D. H a d r y ś, M. M i r o s, Optimization of Operational Properties of Steel Welded Structures, Maintenance and Reliability **3**, 30-33 (2010).
- [5] T. W ę g r z y n, J. M i r o s ł a w s k i, A. S i l v a, D. P i n t o, M. M i r o s, Oxide inclusions in steel welds of car body, Materials Science Forum **636-637**, 585-591 (2010).
- [6] B.E. P a t o n, V.I. L a k o m s k y, Interaction of molten metal with nitrogen from arc plasma, IIW.Doc.II-A-871-92, 1992.
- [7] M. M i r o s, Influence of welding repair works on the operating properties of carrying elements in transport trucks. Doctoral Thesis, Silesian University of Technology, Faculty of Transport, Katowice 2010.
- [8] V.K. G o y a l, P.K. G h o s h, J.S. S a i n i, Influence of Pulse Parameters on Characteristics of Bead-on-Plate Weld Deposits of Aluminium and Its Alloy in the Pulsed Gas Metal Arc Welding Process. Metallurgical and Materials Transactions A **39**, 13, 3260-3275 (2008).
- [9] K. K r a s n o w s k i, Influence of Stress Relief Annealing on Mechanical Properties and Fatigue Strength of Welded Joints of Thermo-Mechanically Rolled Structural Steel Grade S420MC. Archives of Metallurgy **54**, 4, 1059-1072 (2009).
- [10] PN EN 87/M 69772 – Welding. Classification of defective welded joints on the basis of radiographs.
- [11] PN EN 76/H 04326 – Fatigue testing of metals. Bendig test.