

## **MEASUREMENTS OF ASON/GMPLS CONNECTION CONTROL LAYER PERFORMANCE ACCORDING TO ETSI METHODOLOGY**

**Sylwester Kaczmarek, Magdalena Młynarczuk, Marcin Narloch, Maciej Sac**

*Gdańsk University of Technology, Faculty of Electronics, Telecommunications and Informatics, Department of Teleinformation Networks, Narutowicza 11/12, 80-233 Gdańsk, Poland (✉ kasy@eti.pg.gda.pl, +48 58 347 2767)*

### **Abstract**

Measurements of performance have always been crucial for the evaluation of telecommunication systems, especially for implementation of network control elements responsible for connection handling which regards to bandwidth reservation, modification and release. That problem also arises in the Automatically Switched Optical Network/Generalized Multiprotocol Label Switching (ASON/GMPLS) architecture, which is considered as one of the components of Next Generation Network (NGN). The European Telecommunications Standards Institute (ETSI) proposed a universal methodology of telecommunication control elements performance measurements, which can be also adopted to investigation of an ASON/GMPLS connection control layer. In this paper the application of the ETSI measurements methodology with regard to ASON/GMPLS performance is described. The implementation of a laboratory testbed as well as executed performance measurements according to the ETSI methodology and their results are presented.

Keywords: ASON, GMPLS, control performance measurements, ETSI methodology, RSVP, NGN.

© 2012 Polish Academy of Sciences. All rights reserved

### **1. Introduction**

Performance measurements have been essential in telecommunication since its beginning, due to the fact that telecommunications systems have to provide services with strictly defined quality and reliability. Performance of telecommunication control systems handling service requests influences the network response time and consequently user experience and service perception as well as income of network operator. That general rule also applies to current IP networks and future Next Generation Network (NGN) [1] fulfilling the concept of the Global Information Infrastructure (GII) [2]. It is assumed that control elements forming the service stratum (layer) in NGN will be based on IP Multimedia Subsystem (IMS) [3], a platform designed to handle requests for multimedia services. One of the technologies which can be used in NGN transport stratum as resources for services is the Automatically Switched Optical Network (ASON) [4] utilizing Generalized Multi-Protocol Label Switching (GMPLS) [5] protocols. That solution is known as ASON/GMPLS architecture.

ASON/GMPLS architecture also includes control elements, called Connection Control Servers (CCSs), organized in a control layer responsible for handling connection requests regarding reservation, modification and release of optical resources. Since the performance of CCS elements influences the overall network response times for service requests, it must be thoroughly evaluated. Currently, performance measurements of the ASON/GMPLS connection control layer are not standardized. The aim of the paper is to evaluate the possibility of adoption of the European Telecommunications Standards Institute (ETSI) standard [6-8] describing the methodology of performance measurements for IMS service control elements to ASON/GMPLS connection control layer.

The paper is organized as follows. Section 2 is devoted to the description of ETSI methodology of telecommunications system performance measurements. The implemented ASON/GMPLS connection control layer testbed is depicted in section 3. Performance measurements executed in the testbed and their results are presented and discussed in section 4. Conclusions and outlook to future are presented in section 5.

## 2. ETSI methodology of telecommunications system performance measurements

The idea of developing performance measurements has been investigated by ETSI since its establishment. The ETSI TISPAN (Telecommunications and Internet converged Services and Protocols for Advanced Networking) working group, created in 2003, proposed a telecommunication performance tests standard for IP Multimedia Subsystem (IMS) [6-8]. Technical specification ETSI TS 186008 contains an overall description of performance measurements, including test information model, system under test (SUT) configuration, test system (TS) specification, benchmark metrics as well as TS and SUT interaction. Due to limited space in the paper we outline only the main idea and key concepts of the ETSI methodology.

The measurement information model consists of three major elements (Fig. 1): use-cases, benchmark test and test report. Use-cases regard a particular area of the user and telecommunication system interaction. Each use-case includes a collection of scenarios defined by different user behaviors and test system states described by the message flow, for example call setup (successful – scenario 1, called user busy – scenario 2, etc.). One of the most important elements of each use-case is the design objective (DO) notion, which is specified by threshold values of performance metric, e.g. call setup delay. The largest system load which can be handled by SUT without exceeding the DO value is defined as design objective capacity (DOC). The main goal of an ETSI performance test is determination of the system design objective capacity for SUT, which can be characterized by specific parameters.

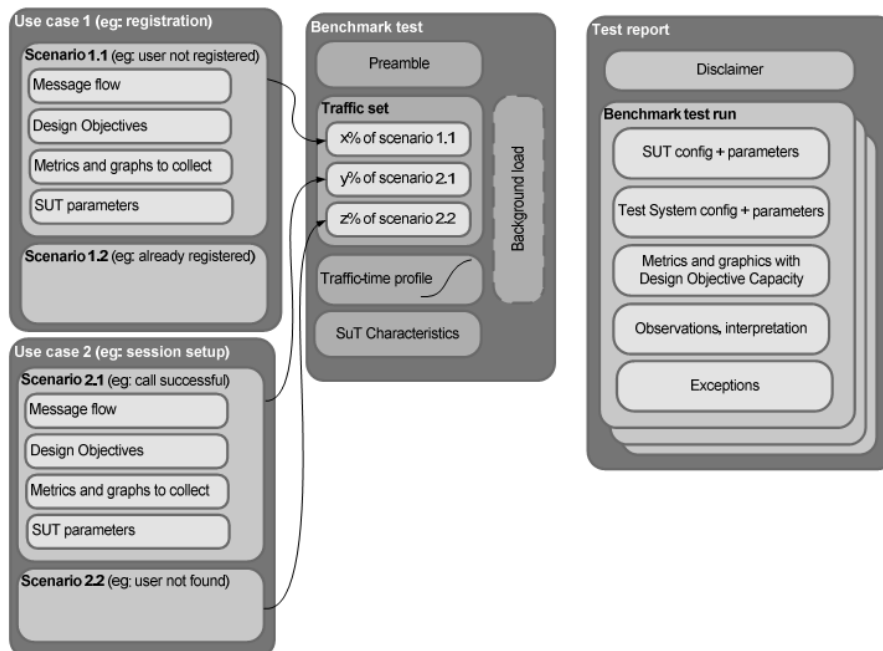

Fig. 1. ETSI performance measurements information model [6].

Another component of ETSI performance measurements information model is a benchmark test, which includes:

- preamble - the sequence of actions necessary to initialize TS and SUT to perform a measurement test,
- traffic set - a set of scenarios that simulated users perform during the test procedure,
- arrival distribution - a description of the arrival rate of scenario occurrences from the traffic set;
- traffic-time profile - a description of the average arrival rate changes as a function of time over the duration of the test,
- SUT characteristics - a description of system under test features important for the measurement.

Optionally a benchmark test may involve a background load applied to SUT in order to increase resource utilization and achieve more realistic test conditions.

A test report is a formal record fully documenting the executed test, including appropriate data files concerning the test system and system-under-test configuration as well as parameters. The main part of a test report are results of performed tests consisting of the numerical values regarding test metrics and their graphical visualization with obtained design objective capacity for standardized or assumed design objective value. Observations and interpretation are notes helpful to understand and interpret the test report. Any unexpected behavior and deviation of TS and SUT are provided in the exceptions part.

A typical test procedure begins with initialization of TS and SUT, called the preamble, which is characteristic for the particular test environment and can for example involve the starting database, “warming-up” traffic generators, etc. After the initialization, TS starts generating a set of scenarios (traffic set) according to the specified traffic-time profile and arrival distribution (Fig. 2). In the ETSI testing methodology traffic-time profiles generally follow a “stairstep” pattern with properly adjusted width (duration, time), height (load increase) and number of steps. A step sequence starts with a moderate load of SUT, then the load increases in each step and brings the SUT progressively to its design objective capacity, the maximal load at which the assumed design objective value is not exceeded.

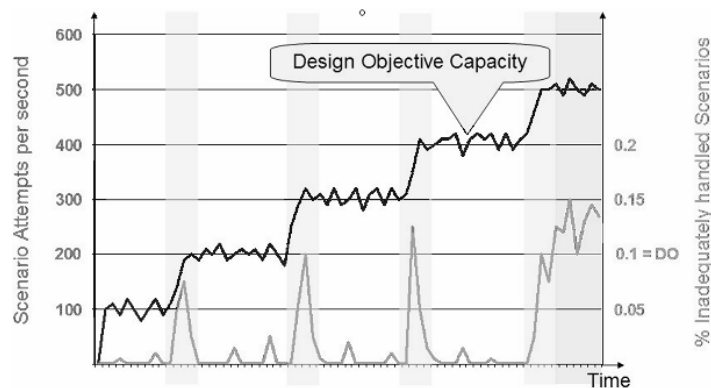

Fig. 2. Typical ETSI performance test sequence [9].

Metric of the system-under-test load is typically service attempts per second (SAPs) which is defined as “the average rate in a one-second period at which scenarios are attempted” [6]. During the test execution another metrics are collected depending on the goal of the test, including [6]:

- transaction response time (TRT) - the time elapsed from the first message sent to initiate the transaction (scenario) until the message that ends the transaction is received,
- CPU usage ratio (CPU) - the ratio of used CPU to the total CPU available, typically expressed as a percentage,
- memory usage ratio (MEM) - the ratio of used memory to the total memory available,

- percent of inadequately handled scenarios (%IHS) - the ratio of inadequately handled scenarios to the total number of attempted scenarios; inadequately handled scenarios are scenarios that do not conform to the message flow defined in the use-case as well as scenarios with exceeded performance criteria mainly regarding the time values of accomplishment (see TRT metric).

The test is finished when the SUT is overloaded and the selected metric such as percentage of inadequately handled scenarios (%IHS) exceeds the design objective (DO).

### 3. Implemented ASON/GMPLS testbed

The implementation of the ASON/GMPLS connection control layer testbed is presented in Fig. 3. The layer consists of Connection Control Servers (CCSs) performing connection control functions. Each CCS server is responsible for dynamic management of optical resources in a transport layer by processing requests for establishing (setting) and releasing (deleting) paths. The data necessary for proper CCS operation are stored in a local database emulating Optical Cross-Connects (OXC) operation. Connection Control Servers utilize the RSVP [10] protocol. The design of Connection Control Server functionality was based on the following assumptions:

- mapping of elements from control layer (CCS) to transport layer (OXC) is one-to-one,
- single reservation session (request) results in reservation of one or more transport units (optical resources), depending on the bandwidth demand request,
- identifiers of optical resources are transported using LMP procedures [11],
- Fixed Filter (FF) bandwidth reservation style is applied [10].

The presented architecture fulfills current ASON/GMPLS standardization.

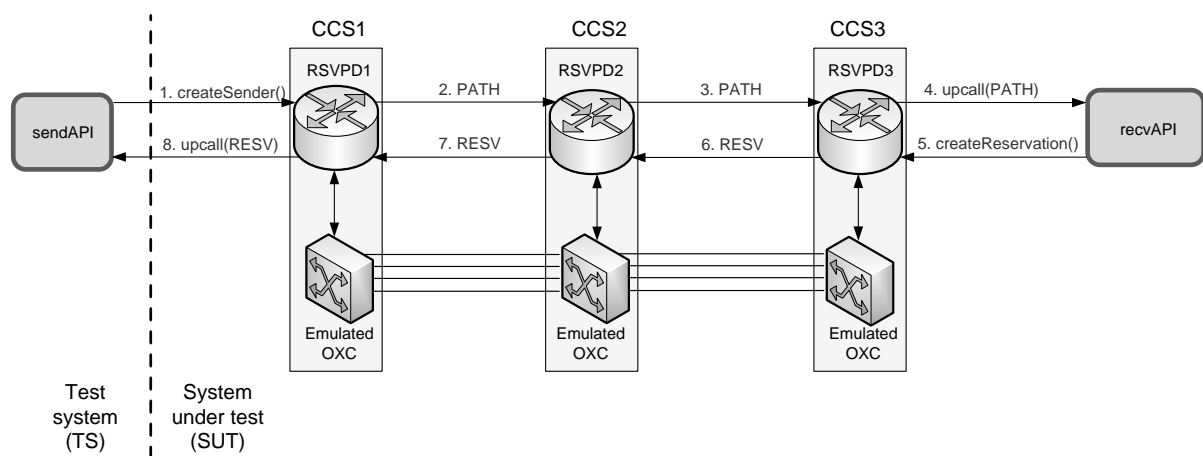

Fig. 3. ASON/GMPLS testbed architecture.

The main functionality of the Connection Control Server is performed by the RSVP Daemon (RSVPD) element, which is a part of Kom RSVP implementation [12, 13] of the RSVP protocol. The functionality of the Kom RSVP project was appropriately extended to transport control information of an optical network [14, 15]. Thus, core functionality of RSVP-TE [16] signaling protocol was achieved. Our extensions of Kom RSVP preserved the original structure of the implementation, with division into RSVP Daemon and RSVP API Client. The role of the API Client is to invoke API functions provided by the RSVP Daemon in order to initiate the process of setting-up and releasing connections in the transport layer. The main functions of the RSVP Daemon include sending, receiving and processing RSVP messages, as well as allocation and release of optical resources emulated by database operations.

In the testbed two kinds of RSVP API Client software are utilized: sender (sendAPI) and receiver (recvAPI) applications. The latter is a part of the system under test and must be started before execution of sender application, which performs the role of a test system and collects performance metrics. A typical optical connection setup (optical resource reservation) scenario begins with invoking the createSender() RSVP API function by the sendAPI application, which causes the RSVP Daemon of the first CCS on the path to send the RSVP PATH message initiating the process of resource reservation. Consecutive CCSs on the path process and forward the PATH message until it reaches the last server on the path. Then the recvAPI application is notified about the resource reservation request by RSVP API upcall() callback function and responds positively using the createReservation() RSVP API function. As a result, the last CCS on the path checks resource availability in its local database and sends a RSVP RESV message to the previous server on the path confirming reservation of local resources. The procedure is repeated consequently until the RESV message reaches the first CCS on the path. After that, the sendAPI application is notified about successful resource reservation on the whole path by the RSVP API upcall() callback function and collects data necessary to calculate the connection setup time. In order to perform a large number of resource reservation requests, an appropriate number of recvAPI and sendAPI applications must be executed.

The developed and implemented software for the ASON/GMPLS network elements has been installed and validated in a laboratory testbed consisting of three CCSs. The results of performed functional tests are presented in [14, 15]. The investigation of single connection handling performance is described in [17]. Due to the fact that system platform hardware parameters have a strong influence on the performance of the implemented ASON/GMPLS architecture, we present a brief description of the utilized equipment. Connection Control Server software has been installed on NTT TYTAN computers with the following hardware parameters:

- Supermicro X8DTL-3F motherboard,
- Intel XEON E5506 (2,13 GHz) quad core processor,
- 4GB DDR3 ECC R RAM memory,
- 2x500GB SATA HDD
- 100 Mb/s Ethernet network connections.

Execution of performance tests required proper configuration of a Debian Linux operating system and implemented software.

#### **4. Connection control layer performance measurements**

In the architecture described in Fig. 3 a set of performance tests according to the ETSI methodology was executed. In order to carry out the tests, dedicated scripts for Linux bash command interpreter and programs in C/C++ language were prepared allowing to fully automate the process of test execution and metric collection. For statistical analysis the measurement data were stored in csv (comma separated) text files.

In our test environment the scenario concerned the connection setup (reservation of optical resources), which is presented in Fig. 3. Due to the fact that only one scenario was considered in tests, SApS metric can be interpreted as a connection request intensity (equal to the number of requests per second). According to the ETSI methodology a "stairstep" traffic-time profile was applied with an initial intensity of 10 requests per second, step height of 10 requests per second and 5 steps (Fig. 4-7). In the tests two types of arrival distributions were considered. The intervals between consecutive requests were constant (Fig. 4, 6) or given by exponential distribution (Fig. 5, 7), which better describes real conditions in telecommunications systems. We applied a Mersenne Twister random number generator to obtain the exponential

distribution values [18]. For each type of the intervals two values of step time duration were tested: 10 seconds (Fig. 4, 5) and 20 seconds (Fig. 6, 7), to demonstrate the importance of proper step duration determination and its influence on the accuracy of performance measurement results such as DOC, which will be discussed in the next part of the section.

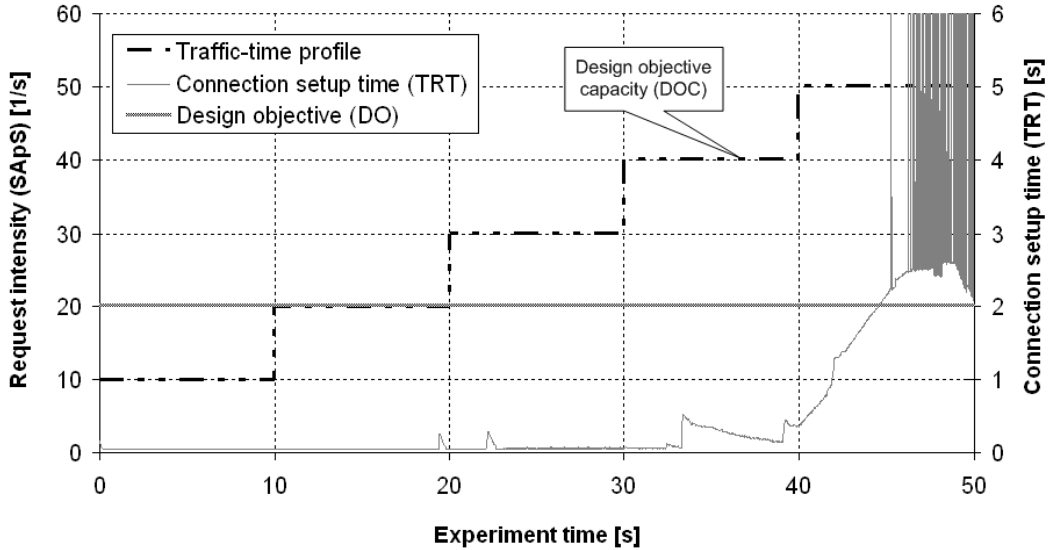

Fig. 4. Connection setup times (TRT) for constant intervals between requests and step time 10s.

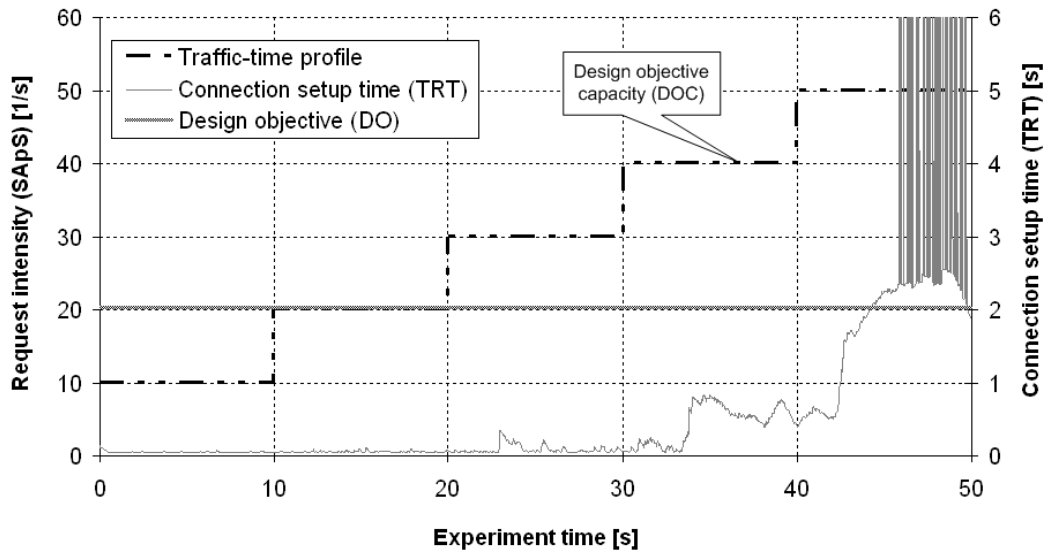

Fig. 5. Connection setup times (TRT) for exponentially distributed intervals between requests and step time 10s.

In our tests we define TRT as a connection setup time, the time between sending the result of RSVP API createSender() function from the sendAPI RSVP API Client to the RSVP Daemon of the first CCS on the path and receiving the information of successful path establishment via the upcall() callback function (Fig. 3). Connection setup time includes delays concerning message processing in CCSs and recvAPI application as well as message sending time via 100Mb/s Ethernet network interfaces. Propagation delay ( $5\mu\text{s}/\text{km}$  for an optical link) is not considered in the experiments due to short (smaller than 1m) distances between testbed elements. However, the effect of propagation delay in larger distances can be easily included in final results by simple addition operation.

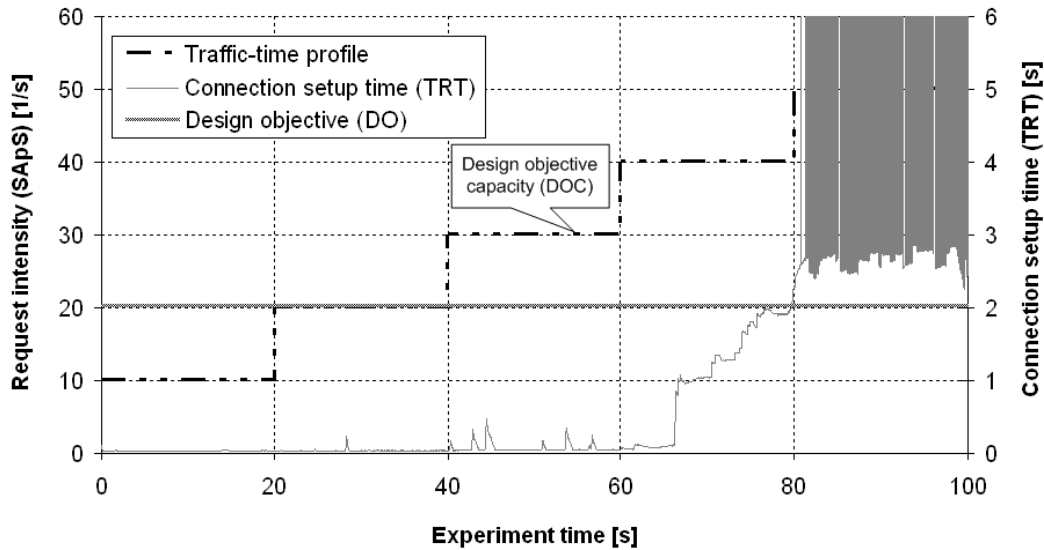

Fig. 6. Connection setup times (TRT) for constant intervals between requests and step time 20s.

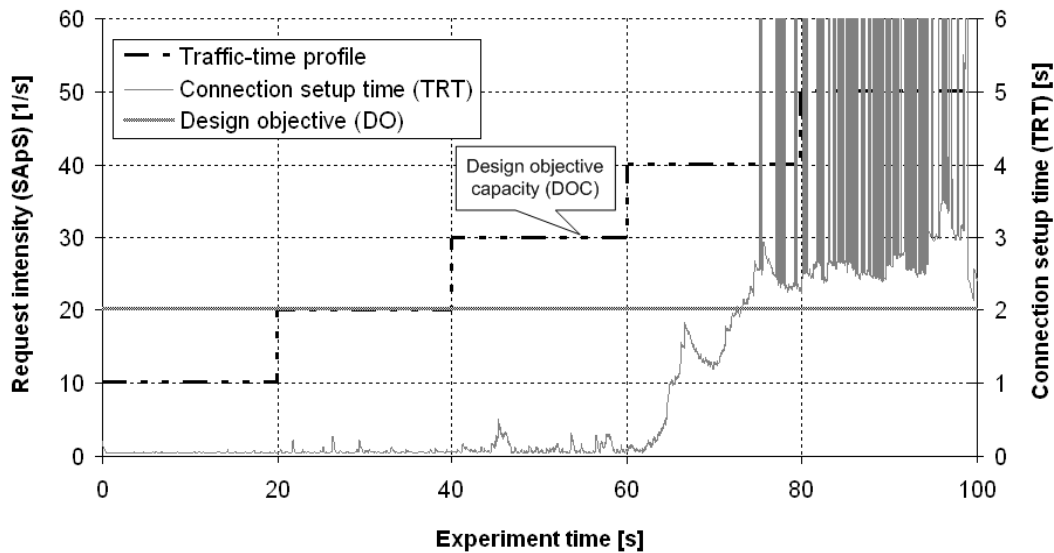

Fig. 7. Connection setup times (TRT) for exponentially distributed intervals between requests and step time 20s.

At the beginning of each test some actions were performed involving: initialization of resource databases, starting RSVP Daemon and RSVP API Client applications (receivers, senders), which can be treated as a test preamble. Then the appropriate test procedure started and the results were collected in csv files. Results of all performed tests were processed and statistically analyzed in order to obtain the graphs presented in Fig. 4-8. The presented graphs can be considered as a part of the test report in ETSI methodology. Due to the scientific character of the paper and limited space, the form of the results presentation differs from a formal test report.

As it can be noticed in Fig. 4-7, connection setup time (TRT) highly depends on the SUT load, which is expressed as connection request intensity (SAPs). For an intensity up to 30 requests per second, the TRT is low, as it can be observed in Fig. 4-7. TRT starts to grow significantly for SAPs equal to 40 requests per second and the SUT in such condition has a tendency to respond much slower. For a step duration of 10s it seems that an intensity of 50 requests per second is the value from which the SUT is overloaded and starts to behave unstably (Fig. 4, 5). In such a case TRT values are greater than 2 seconds and achieve in

many cases even several tenths of seconds. In case of tests with 20s step duration a similar situation occurs at 40 requests per second (Fig 6, 7). The described results are independent of the arrival distribution. However, for exponentially distributed intervals between requests TRT values are more sensitive to request intensity changes and an intensity increase leads to more significant growth of TRT, especially for more than 30 requests per second (Fig. 4-7).

In order to confirm the mentioned remarks, we investigated the histogram of TRT for exponential distribution of time between requests and 20s step duration for three values of SApS: 20, 30, 40 request per second (Fig. 8). TRTs for 20 requests per second are very small and concentrated around 0.1s, but when SApS increases to 30 and 40 requests per second, TRT values are spread over the whole range of times up to 0.5s and even more than 2s (which is not shown in the histogram range due to preserve the presentation quality) respectively.

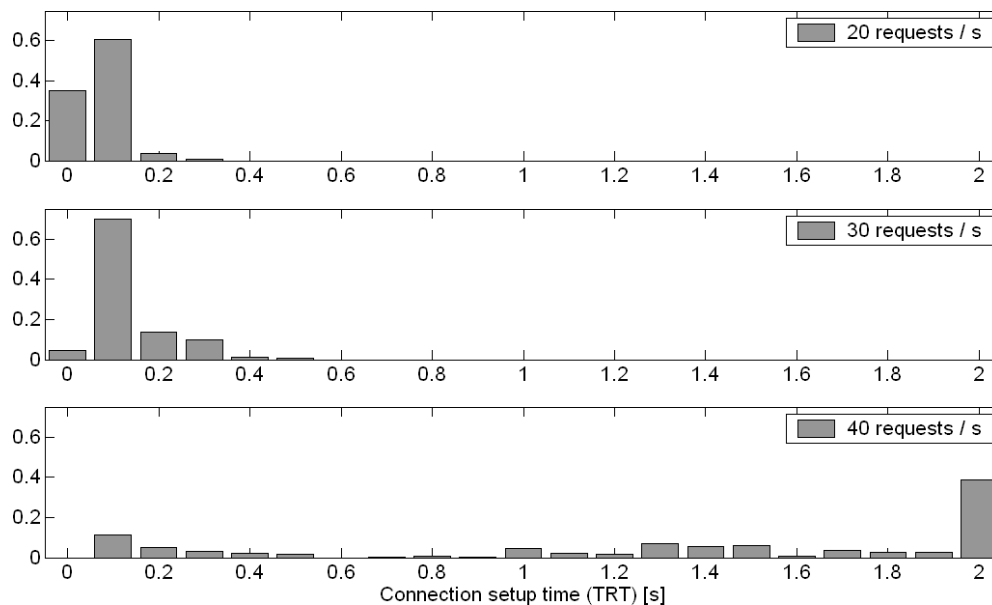

Fig. 8. Normalized histogram of connection setup times (TRT) for exponentially distributed intervals between requests, step time 20s and different SApS values.

For the time being, there are no standards for an ASON/GMPLS network describing the maximal values of connection setup time. In our tests we assumed 2s of TRT as the design objective (DO). For tests with 10s step duration (Fig. 4, 5), the maximal value of request intensity at which DO is preserved (design objective capacity, DOC) is equal to 40 requests per second. However, considering system state evolution it can be noticed that a step time duration of 10 seconds is too short to appropriately load the SUT, which does not enter its stable state, and for that reason the obtained design objective capacity of 40 requests per second is overestimated. In such situation the achieved test results are not reliable and a longer step duration is necessary. In order to prove that thesis, we performed tests with the 20s step duration presented in Fig. 6-7 and obtained a DOC equal to 30 requests per second since SUT started to behave unstably at a request intensity of 40 requests per second. An additional test executed for 100s with a single step and fixed intensity of 30 requests per second confirmed that DOC value. In the test, average and maximal TRT values were equal to 0.082s and 0.588s respectively.

In ETSI methodology all scenarios for which the design objective is exceeded are treated as inadequately handled. In our case, inadequately handled scenarios (IHS) are all connection requests with the setup time exceeding 2s. Thus, for each executed test and request intensity above the DOC value the percent of inadequately handled scenarios (%IHS) is greater than zero.



As it has already been mentioned, propagation delay was not considered in the paper but it can be taken into account by properly increasing the connection setup delay according to the total length of all optical links. Equivalently, the influence of propagation delay can be included by appropriate reduction of DO threshold. On the other side, if the total length of all optical links on the path is equal to 1000km, the one-way propagation delay of 20ms (40 ms for both ways, concerning sending request and receiving response) is negligible in comparison with connection setup times of several seconds for request intensities close to DOC.

## **5. Conclusions**

The paper regards measurements of telecommunications systems performance according to the ETSI methodology, originally designed for IMS architecture. The methodology was applied to investigate the performance of the connection control layer in the implemented ASON/GMPLS laboratory testbed. Utilized metrics were request intensity (SApS) and connection setup time (TRT). The tests were executed for different conditions involving arrival distribution and step duration in the traffic-time profile. Characteristics of obtained results conform to the general concept of the ETSI test and are similar to the exemplary results provided in ETSI standard TS 186 008.

Experience gained during test environment implementation confirms that application of the ETSI methodology is not trivial and requires some knowledge about the system under test. The remark regards especially the traffic-time profile and parameters of its particular steps. The duration (width) of each step should be sufficient to collect a representative set of samples at a constant intensity in each step. Proper step time duration choice is required for an evaluated SUT to enter the stable state after a SApS increase. For a load above the DOC value, stabilization of SUT is not possible independently of the step duration, however, finding the design objective capacity is the aim of an ETSI performance test. Furthermore, appropriate step height (load increase) selection influences the accuracy of DOC determination. Smaller step height leads to better DOC accuracy with the disadvantage of longer test duration and higher resource utilization.

In order to test an ASON/GMPLS connection control layer in real conditions, exponentially distributed intervals between requests were considered, which occurred to be more difficult for the SUT to handle. Executed tests allowed to determine the ASON/GMPLS testbed performance and find the design objective capacity for the assumed value of DO (maximal value of TRT). The implemented testbed is characterized by high performance and can deal with high request intensity.

The experiments carried out proved that performance measurement methodology standardized by ETSI could be adopted to network architectures other than IMS. However, the methodology regards only the process of measurements and determination of DOC. Statistical analysis regarding confidence intervals and other metrics is omitted in the TS 186 008 standard. Our future work will include more extensible tests of the ASON/GMPLS testbed covering more use-cases with different network topologies, configuration and background load. We are also planning to investigate the possibility of extending existing ETSI methodology towards statistical analysis of test results.

## **Acknowledgements**

This work was partially supported by the Ministry of Science and Higher Education, Poland, under the grant PBZ-MNiSW-02-II/2007.

## References

- [1] ITU-T Recommendation Y.2012 (2010). Functional Requirements and architecture for next generation networks.
- [2] ITU-T Recommendation Y.100 (1998). General overview of the Global Information Infrastructure standards development.
- [3] 3GPP TS 23.228 (2011). IP Multimedia Subsystem (IMS); Stage 2 (Release 11), v11.0.0.
- [4] ITU-T Recommendation G.8080/Y.1304 (2006). Architecture for the Automatically Switched Optical Network (ASON).
- [5] Mannie, E. (2004). *Generalized Multi-Protocol Label Switching (GMPLS) Architecture*, IETF RFC 3945.
- [6] ETSI Technical Specification TS 186 008-1 (2007). Telecommunications and Internet converged Services and Protocols for Advanced Networking (TISPAN); IMS/NGN Performance Benchmark, Part 1: Core Concepts, v1.1.1.
- [7] ETSI Technical Specification TS 186 008-2 (2007). Telecommunications and Internet converged Services and Protocols for Advanced Networking (TISPAN); IMS/NGN Performance Benchmark, Part 2: Subsystem Configurations and Benchmarks, v1.1.1.
- [8] ETSI Technical Specification TS 186 008-3 (2007). Telecommunications and Internet converged Services and Protocols for Advanced Networking (TISPAN); IMS/NGN Performance Benchmark, Part 3: Traffic Sets and Traffic Profiles, v1.1.1.
- [9] Detrez, J.-L. (2007). ETSI TS 186.008: a Standard-Based Benchmark for IMS. In *11<sup>th</sup> International Conference on Intelligence in service delivery Networks, ICIN 2007*, Bordeaux, France.
- [10] Braden, R., et al. (1997). *Resource ReSerVation Protocol (RSVP) -- Version 1 Functional Specification*, IETF RFC 2205.
- [11] Fredette, A., et al. (2005). *Link Management Protocol (LMP) for Dense Wavelength Division Multiplexing (DWDM) Optical Line Systems*, IETF RFC 4209.
- [12] Karsten, M. (2000). Design and Implementation of RSVP based on object relationships. In *Proceedings of Networkings 2000*, Paris, France, Springer LNCS, 325-336.
- [13] Karsten, M., Schmitt, J., Steinmetz R. (2001). Implementation and Evaluation of the KOM RSVP Engine. In *Proceedings of the IEEE, INFOCOM'2001*.
- [14] Kaczmarek, S., Młynarczyk, M., Waldman, M. (2010). The realization of ASON/GMPLS Control Plane. In *Information Systems Architecture and Technology. System Analysis Approach to the Design, Control and Decision Support*, Wroclaw, Wroclaw University of Technology Publishing House, 313-324.
- [15] Kaczmarek, S., Młynarczyk, M., Waldman, M. (2010). RSVP-TE as a reservation protocol for optical networks. In *PWT 2010, XIV Poznań Telecommunications Workshop*, Poznań, Faculty of Electronics and Telecommunications at Poznan University Technology, 28-31.
- [16] Awduche, D., et al. (2001). *RSVP-TE: Extensions to RSVP for LSP Tunnels*, IETF RFC 3209.
- [17] Kaczmarek, S., Młynarczyk, M., Narloch, M., Sac, M. (2011). Evaluation of ASON/GMPLS Connection Control Servers Performance. In *Information Systems Architecture and Technology. Service Oriented Networked Systems*, Wroclaw, Wroclaw University of Technology Publishing House, 267-278.
- [18] Matsumoto, M., Nishimura, T. (1998). Mersenne Twister: A 623-dimensionally equidistributed uniform pseudorandom number generator. *ACM Transactions on Modeling and Computer Simulation*, 8(1), 3-30.