

## VARIABLE-FREQUENCY PRONY METHOD IN THE ANALYSIS OF ELECTRICAL POWER QUALITY

Jarosław Zygarlicki<sup>1)</sup>, Janusz Mroczka<sup>2)</sup>

1) Opole University of Technology, Institute of Power Engineering, Prószkowska 76, 45-758 Opole, Poland (✉ j.zygarlicki@po.opole.pl, +48 77 40 00 547)

2) Wrocław University of Technology, Chair of Electronic and Photonic Metrology, Bolesława Prusa 53/55, 50-317 Wrocław, Poland (janusz.mroczka@pwr.wroc.pl, +48 71 320 62 32)

### Abstract

The article presents a new modification of the the least squares Prony method. The so-called variable-frequency Prony method can be a useful tool for estimating parameters of sinusoidal components, which, in the analyzed signal, are characterized by time-dependent frequencies. The authors propose use of the presented method for testing the quality of electric energy. It allows observation of phenomena which, when using traditional methods, are averaged in the analysis window. The proposed modification of least squares Prony method is based on introduction and specific selection of a frequency matrix. This matrix represents frequencies of estimated components and their variability in time.

Keywords: Power quality, Prony method, harmonics, measurements.

© 2012 Polish Academy of Sciences. All rights reserved

### 1. Introduction

The Prony analysis is a parametric method that least-squares (LS) fits a sum of damped complex exponentials [1-7]. The method outperforms its Fourier transform counterpart [8] in the accuracy of signal modeling and analysis for many practical signal processing situations. The advantages of the LS Prony method are precise estimation of frequency, amplitude and phase, in addition to the ability of computation of damping factors for the signal components; however, the Prony method is also known to behave poorly when a signal is embedded in additive noise. Other similar methods that give more precise results in certain conditions, such as e.g. total LS [9] and matrix-pencil methods [10, 11], are also worth mentioning.

The method presented in the article is a modification of the Prony method that additionally offers the possibility of testing signal sinusoidal components with frequencies varying in the analysis window, with the same high accuracy of component parameter estimation, and lower computational complexity compared to least squares Prony method. For proper operation of the method, however, information about the frequencies of sinusoidal components and their variability in time is required.

The so-called variable-frequency Prony method can be applied in specific areas of signal processing. In particular, for the analysis of electric power signals for which required information on component harmonic frequencies and their variability in time can be acquired with some approximation error by parametric methods with short moved analysis window [2, 7, 12], or additional electronic sensors.

The authors also work on modification of a least squares Prony method part responsible for identification of components in the signal, so that it will be possible to determine component frequencies and their variability in the analysis window for applications in which this information is not available. Some equivalent to the method being developed can be a method

described in publications [13]. Unfortunately, this method has drawbacks typical for Fourier analysis [14].

In applications for studying electric power quality, traditional methods of signal analysis based on Fourier transformation very often do not give satisfactory results. The main reason for their use is relatively low computational power required from devices on which it is implemented, which in the era of a rapid development of digital signal processor (DSP) systems is not justified. The main disadvantages of Fourier methods include for example:

- spectrum leakage
- necessity of analysis window synchronization
- low frequency or time resolution in time-frequency representation

The variable-frequency Prony method presented in the article does not have these disadvantages.

## 2. Method description

### 2.1. Prony method

The Prony method represents a signal as a combination of exponential functions [15]:

$$\hat{x}_n = \sum_{k=1}^p h_k z_k^{n-1} \quad (1)$$

where  $h_k$  represents a time-independent parameter defined as:

$$h_k = a_k \exp(j\theta_k) \quad (2)$$

and  $z_k$  represents a time-dependent parameter, defined as:

$$z_k = \exp((\alpha_k + j2\pi f_k)T) \quad (3)$$

for  $n = 1, 2, \dots, N$ , where  $N$  – the length of signal,  $p$  – the number of exponentials,  $T$  – the sampling period in seconds,  $a_k$  – the amplitude of  $k$ th complex exponentials,  $\alpha_k$  – the damping factor in seconds<sup>-1</sup>,  $f_k$  – the sinusoid frequency in Hz and  $\theta_k$  – the initial phase of the  $k$ th sinusoid in radians.

### 2.2. Variable-frequency Prony method

Let us assume that all frequencies  $f_k$  in the known frequency vector  $f$  are time-dependent. In this case, the known frequency vector  $f$  becomes matrix  $F$  with the size of  $N \times K$  and represents frequency changes of all sine curves  $K$  of positive frequencies in discrete time  $N$ , where  $K = p/2$ .

Suitably modifying equations (7) and (8) from article [1] we obtain:

$$\text{Re}\{Z_{n,k}\} = \frac{1}{\sqrt{1 + (\tan(2\pi TF_{n,k}))^2}} \quad (4)$$

$$\text{Im}\{Z_{n,k}\} = \frac{\tan(2\pi TF_{n,k})}{\sqrt{1 + (\tan(2\pi TF_{n,k}))^2}} \quad (5)$$

where vector  $z$  now becomes matrix  $Z$  with size  $N \times K$ , for  $n = 1, 2, \dots, N$  and  $k = 1, 2, \dots, K$ . The next step is to apply equation (16) from [1] instead of the Vandermonde matrix. The equation is modified as follows:

$$V_{n,k} = \exp(t_{n,k} \cdot B_{n,k}) \quad (6)$$

where:

$$t_{n,k} = \begin{bmatrix} t_1 & t_1 & \dots & t_1 \\ t_2 & t_2 & \dots & t_2 \\ \vdots & \vdots & \ddots & \vdots \\ t_N & t_N & \dots & t_N \end{bmatrix} \quad (7)$$

and  $B_{n,k} = \ln(Z_{n,k})$ . Note that in equation (6) the expression  $t_{n,k} \cdot B_{n,k}$  is not a typical multiplication of two matrices, only a multiplication of matrix elements.

In the next step we add negative frequencies, which are essential for a correct estimation of sought component parameters for the analyzed signal. Negative frequencies are added by supplementing matrix  $V$  with a value linked to its elements, according to relation:

$$V := [V \quad \text{conj}(V)] \quad (8)$$

Other calculations in the modified method are the same as in the least squares Prony method. First, using the method of least squares [15-17] we calculate vector  $h$ :

$$h = (V^T \cdot V)^{-1} \cdot V^T \cdot x \quad (9)$$

for:  $x^T = [x_1 \ x_2 \ \dots \ x_N]$ , where  $x_n$  – value of  $n$ -th sample of the analyzed signal, for  $n = 1, 2, \dots, N$ , and  $h^T = [h_1 \ h_2 \ \dots \ h_p]$ . From vector  $h$  components we calculate amplitudes and initial phases of signal components according to the relation:

$$a_k = |h_k| \quad (10)$$

$$\theta_k = \tan^{-1} \left( \frac{\text{Im}\{h_k\}}{\text{Re}\{h_k\}} \right) \quad (11)$$

The described algorithm can be schematically represented by Fig. 1.

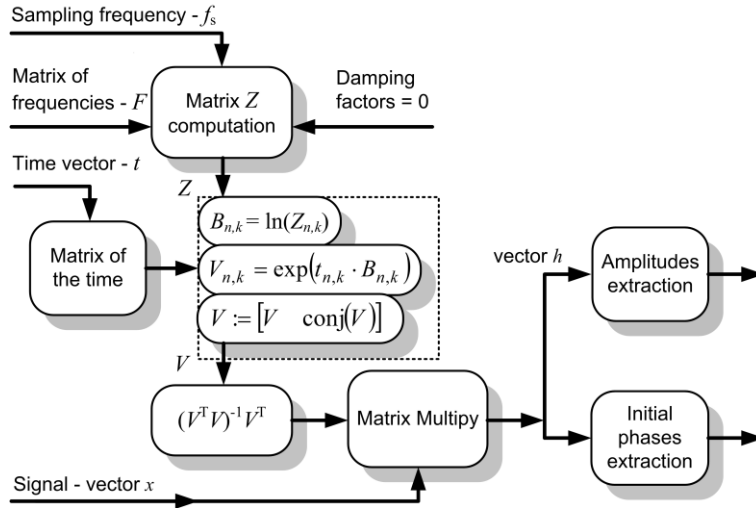

Fig. 1. Variable-frequency reduced least squares Prony method.

### 3. Simulations

The variable-frequency reduced least squares Prony method was tested for its accuracy in determination of amplitudes and initial phases for all analyzed variable-frequency components, as shown in Fig. 2.

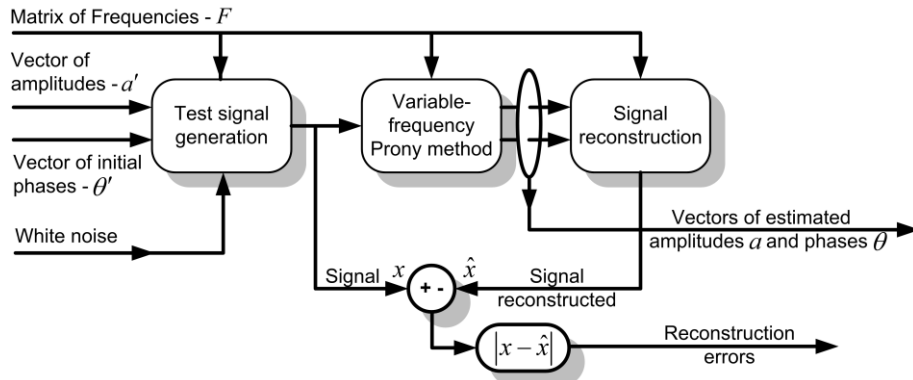

Fig. 2. Variable-frequency least squares Prony method - method for examination of parameter determination accuracy.

The test signal is generated on the basis of a fixed matrix  $F$  of known frequencies. In the next step the generated signal is analyzed using the variable-frequency Prony method. The estimated parameters and matrix of known frequencies are then used to reconstruct the modeled signal. However, a certain reconstruction error for matrix  $F$  is also accounted for, in order to achieve the conditions that are close to the conditions of real measurements.

In the last step the original signal is compared with the reconstructed signal and the maximum absolute reconstruction error is calculated:

$$e_x = \max|x - \hat{x}| \quad (12)$$

where  $x$  and  $\hat{x}$  are the signal and its estimate, respectively. The maximum absolute reconstruction error is a useful criterion in assessing the accuracy of the variable-frequency Prony method, as shown in article [1], yet the maximum absolute error of amplitude and

initial phase of individual components has also been used with reference to the normative requirements of testing the quality of electric power:

$$e_a = \max|a' - a| \tag{13}$$

$$e_\theta = \max|\theta' - \theta| \tag{14}$$

where:  $a'$  – vector of set amplitudes,  $a$  – vector of estimated amplitudes,  $\theta'$  – vector of set initial phases,  $\theta$  – vector of estimated initial phases.

A signal composed of 25 sinusoidal components has been generated (with a sampling frequency of 12.8 kHz and length 0.2s [18]) for tests using the variable-frequency Prony method. The amplitude of the first component is 100, and the amplitudes of the successive components have been determined on the basis of maximum allowable values defined in [19] – Fig. 3. The frequencies of individual components make multiples of the frequency of the time-dependent fundamental component. In the analyzed window, the frequency of the fundamental component varies from 49.99 Hz to 50.01 Hz, thus the frequency of e.g. the second harmonic varies from 99.98 Hz to 100.02 Hz. The signal has been additionally extended by the 26th component which is not synchronized with the variability of the fundamental component. The component is an example of the signal which, when used in modern testers of electric power quality, is averaged in the analyzed window and brings an increase in measurement errors in these devices. An example of the source of such components is shown in Fig. 15.

The amplitude of the additional component is 1; its frequency varies from 175 Hz to 225 Hz in the window of analysis which has been demonstrated in Fig. 4.

Phases of all components of test signals have been selected at random (normal distribution). Moreover, the test signal is expanded by normal white noise and the matrix of known frequencies  $F$  is modified. When generating the test signal, a certain fixed value of frequency error is added to the matrix  $F$ . The test signal with normal white noise of level  $SNR$  (Signal to Noise Ratio defined in [16]) and absolute reconstruction errors is presented in Fig. 5. The effect of white noise is shown in Figs. 6, 7, 8 and 12. The impact of matrix  $F$  reconstruction error is presented in Figs. 9, 10, 11 and 12.

Due to the assumption of the proposed algorithm’s sensitivity to the initial phase of the signal components, a series of analyses have been conducted – Fig. 13. These analyses show little effect on the maximum absolute reconstruction error.

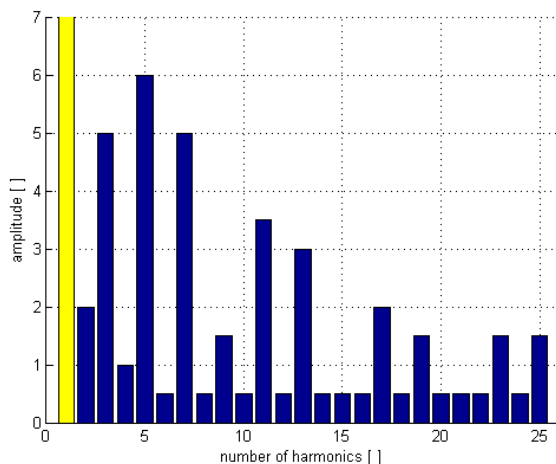

Fig. 3. Amplitudes of the harmonics of test signal according to the acceptable value defined in standard [19].

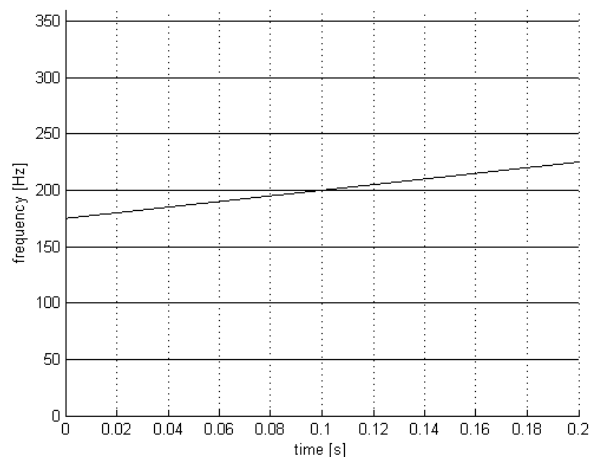

Fig. 4. Fragment of harmonics variability in the test signal.

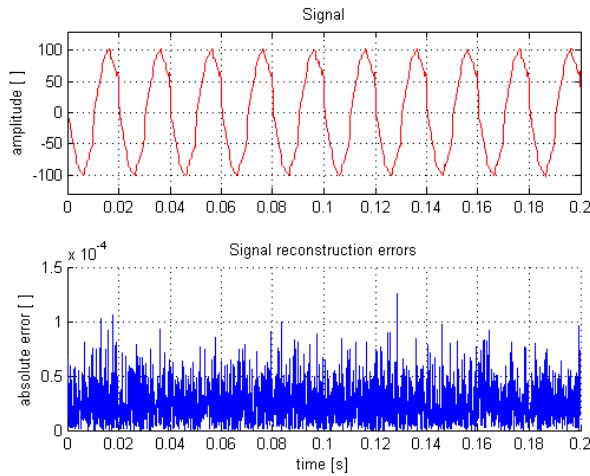

Fig. 5. Test signal with normal white noise  $SNR=90dB$ , matrix  $F$  without error (upper figure) and absolute reconstruction errors (lower figure).

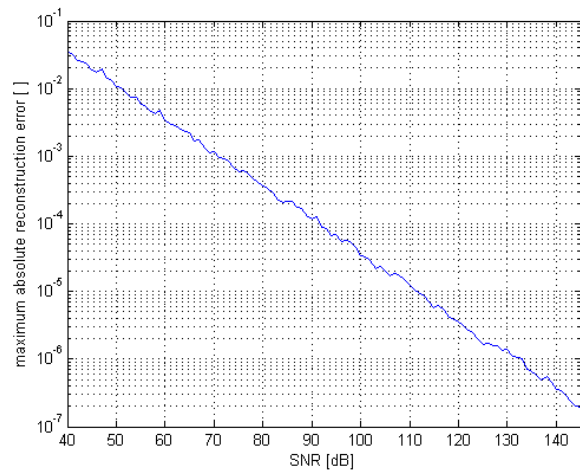

Fig. 6. Maximum absolute **reconstruction error** for a test signal with white noise addition – parameter  $SNR$ , matrix  $F$  without error.

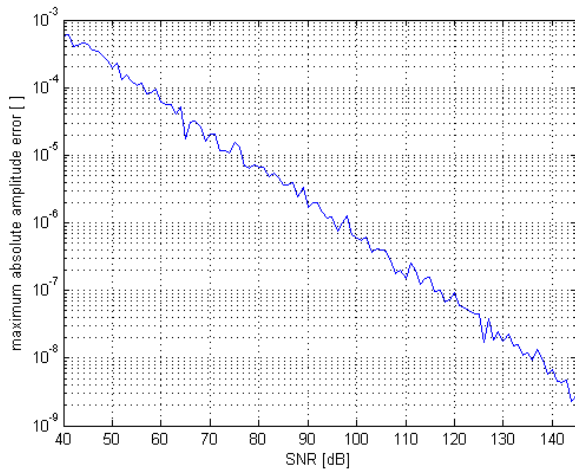

Fig. 7. Maximum absolute **amplitude error** for a test signal with white noise addition – parameter  $SNR$ , matrix  $F$  without error.

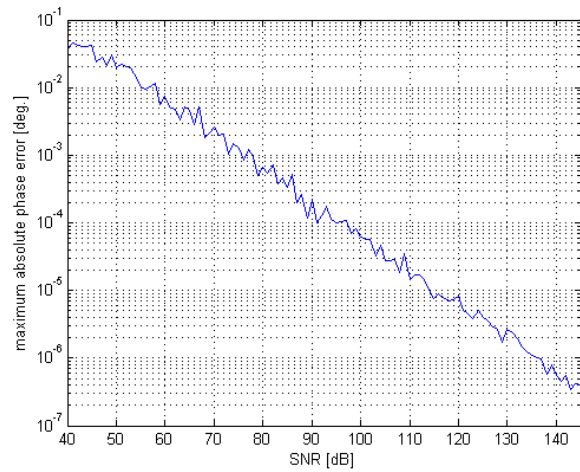

Fig. 8. Maximum absolute **phase error** for a test signal with white noise addition – parameter  $SNR$ , matrix  $F$  without error.

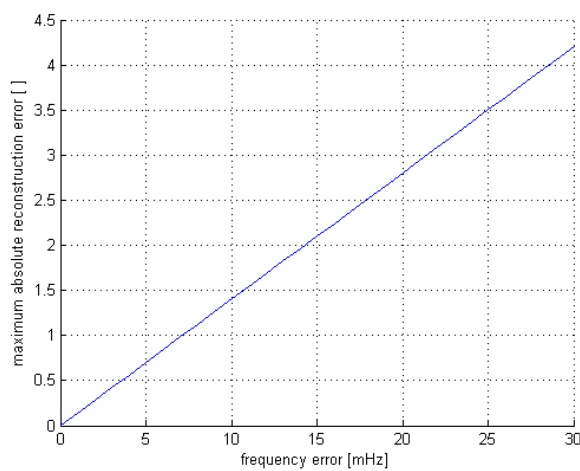

Fig. 9. Maximum absolute **reconstruction error** for test signal with white noise ( $SNR=90$  dB) and matrix  $F$  **frequency deviation**.

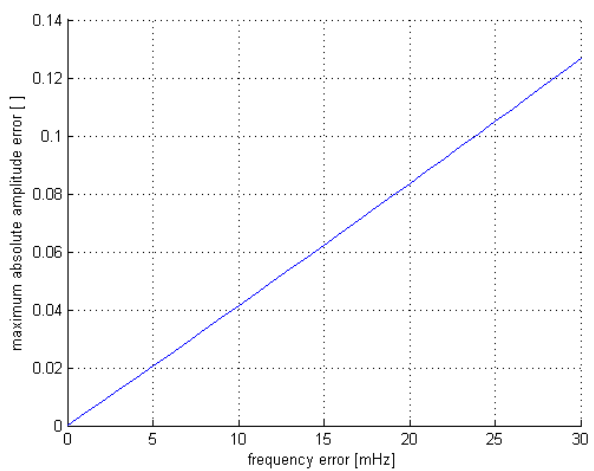

Fig. 10. Maximum absolute **amplitude error** for test signal with white noise ( $SNR=90$  dB) and matrix  $F$  **frequency deviation**.

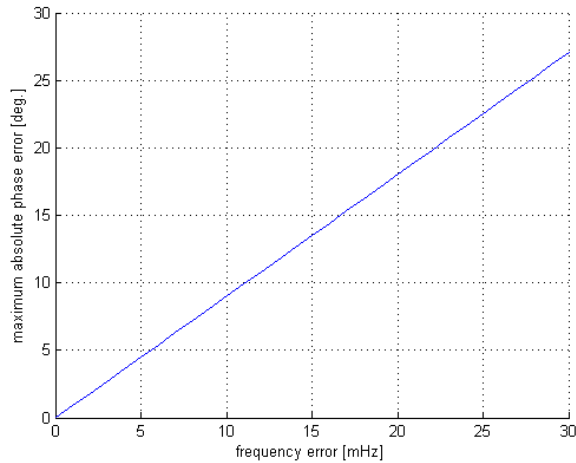

Fig. 11. Maximum absolute **phase error** for a test signal with white noise ( $SNR=90$  dB) and matrix  $F$  frequency deviation.

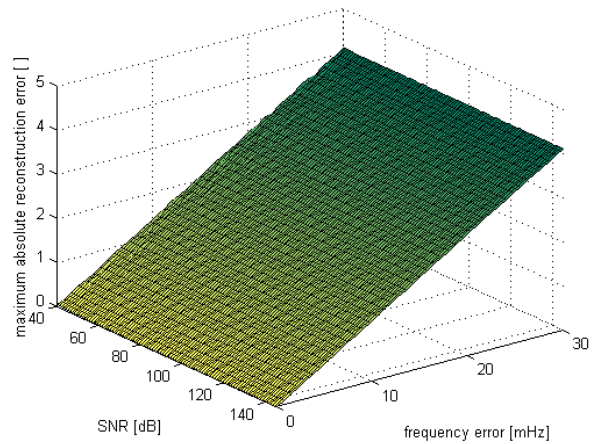

Fig. 12. Maximum absolute reconstruction error for a test signal with white noise – parameter  $SNR$  and matrix  $F$  frequency deviation.

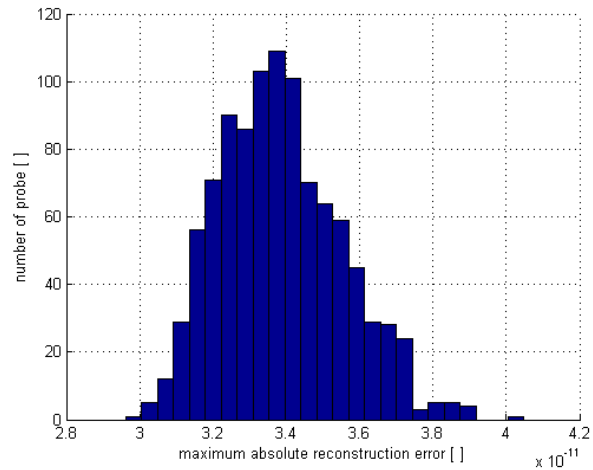
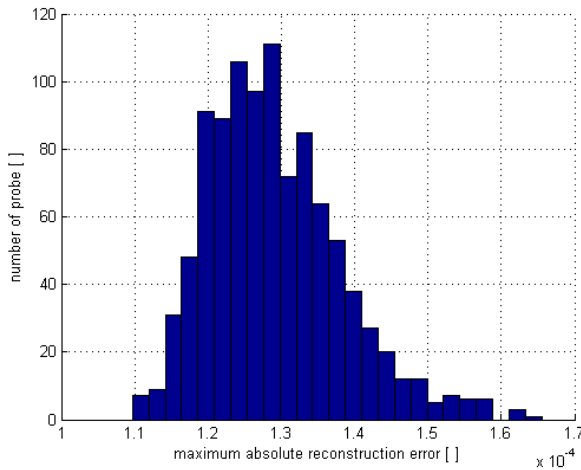

Fig. 13. Histograms of maximum absolute reconstruction error for a test signal with random phases (values from the uniform distribution in the interval  $[0^\circ, 360^\circ]$ ). Left – signal with normal white noise ( $SNR=90$  dB), right – signal without noise. Matrix  $F$  without error.

#### 4. Results

The presented simulation shows that by using the proposed method it is possible to analyze additional harmful phenomena in power networks - testing parasitic components of any known frequency deviation.

The precondition for achieving accurate results required by the standard [20] is guaranteeing high precision of measuring the frequencies of the components. For instance, for class A devices, where the harmonic amplitude error should be  $5\% U_m$  for  $U_m \geq 1\% U_N$  and  $0.05\% U_N$  for  $U_m < 1\% U_N$ , where  $U_m$  is the measured voltage value and  $U_N$  is the expected value at the input of the testing device, the allowable deviation in frequency determination for matrix  $F$  should not be greater than 12 mHz (Fig. 10) for  $0.05\% U_N$ .

The study proves that the presence of noise in the analyzed signal is not so significant. It is possible to test the frequency with given accuracy using already-known methods e.g.  $\pm 143.0 \mu\text{Hz}$  [2]. The presented method allows measurements in accordance with valid standards, making it possible at the same time to monitor the components coming e.g. from disturbing loads that are averaged in the analyzed window of modern recorders.

## 5. Applications

The presented method can be applied in many fields of signal analysis applications. In the publication we proposed an implementation of the described variable-frequency Prony method to study electric power quality. The exemplary application method (Fig. 14) assumes algorithm implementation in a DSP (Digital Signal Processor) signal processor. The analyzed signal is fed to an analog-to-digital processing block and then the sampled signal is transmitted in digital form to the DSP system. In the proposed solution, information on component frequencies: the fundamental harmonic and other harmonics correlated with it (being its multiples) is obtained by a separate method for determining the period of electric power signal and transmitted to the algorithm implemented in the DSP system. Methods for determining frequencies and harmonics of electric power signal are beyond this publication. One can use, for example, the method of zero transition detection or other [2, 7, 12].

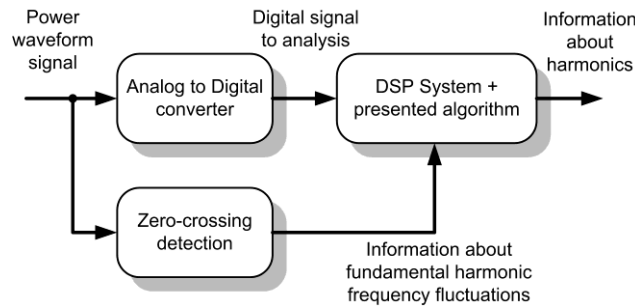

Fig. 14. Variable-frequency least squares Prony method – example of its application in an electrical power quality monitoring system.

The described example (Fig. 14) is presently implemented using the Fourier transform with sampling frequency synchronization, which significantly complicates the design of a monitoring device and causes deviation of signal time logs.

The proposed algorithm can serve as an alternative to the known solutions. It is characterized by lower errors while analyzing signals with long time windows. It also allows to attach additional information to the electric power quality analysis algorithm, if interfering frequencies are known. This situation can occur, for example, when monitoring interferences generated by electric motors, where in addition to the fundamental harmonic and its multiples (harmonics) in the analyzed signal there are interferences correlated with instantaneous speed of the motor shaft (Fig. 15).

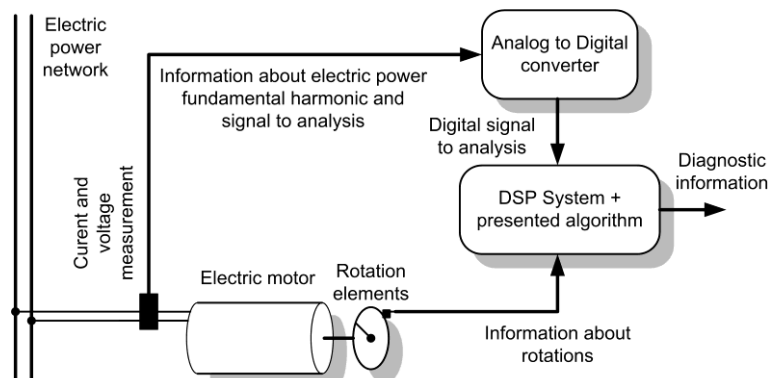

Fig. 15. Variable-frequency least squares Prony method – example application in electrical power quality monitoring system with additional information on interfering frequencies.



In such applications, conventional equipment for monitoring electric power quality based on Fourier transform does not perform, due to averaging or ignoring interferences generated in systems with electric power motors.

## 6. Conclusions

The method developed and presented here allows accurate determination of amplitudes and initial phases for sinusoidal signal components whose frequencies vary in the analyzed window. The only requirement to make a correct estimation of signal component parameters is to know the frequencies of individual components and their variability in time.

Performed simulation studies reveal advantages of this method over other previously used methods, of which the most popular are Fourier methods. It is important that the simulation studies were performed for various test signals, making it a more versatile method than Fourier transformations and allows to apply it in various fields of technology. The authors propose the use of the presented method for testing the quality of electric energy. The presented method allows precise analysis of harmonic signals, while maintaining long measurement windows providing low frequency (subharmonics) analysis.

The method presented and tested in the simulation process is easy to program in DSP (Digital Signal Processing) systems, and because of extensive implementation of various technologies of this technique the presented method is an easy and friendly tool for estimation and on-line analysis of actual signals in a wide range of possible applications.

## References

- [1] Zygarlicki, J., Zygarlicka, M., Mroczka, J., Latawiec, K. (2010). A reduced Prony's method in power quality analysis – parameters selection. *IEEE Transactions on Power Delivery*, 25(2), 979-986.
- [2] Zygarlicki, J., Mroczka, J. (2011). Short time algorithm of power waveforms fundamental harmonic estimations with Prony's methods use. *Metrology and Measurement Systems*, 18(3), 33-38.
- [3] Zygarlicki, J., Zygarlicka, M., Mroczka, J. (2009). Prony's method in power quality analysis. *Energy Spectrum*, 4(2), 26-30.
- [4] Zygarlicki, J., Mroczka, J. (2006). Data compression using Prony's method and wavelet transform in power quality monitoring systems. *Metrology and Measurement Systems*, 13(3), 237-251.
- [5] Feilat, E.A. (2006). Detection of voltage envelope using Prony analysis-Hilbert transform method. *IEEE Trans. Power Del.*, 21(4), 2091-2093.
- [6] Feilat, E.A. (2006). Prony analysis technique for estimation of the mean curve of lightning impulses. *IEEE Trans. Power Del.*, 21(4), 2088-2090.
- [7] Nam, S.R., Kang, S.H., Park, J.K. (2002). An analytic method for measuring accurate fundamental frequency components. *IEEE Trans. Power Del.*, 17(2), 405-411.
- [8] Lobos, T., Leonowicz, Z., Rezmer, J., Schegner, P. (2006). High-resolution spectrum-estimation methods for signal analysis in power systems. *IEEE Trans. Instrum. Meas.*, 55(1), 219-225.
- [9] Markovsky, I., Van Huffel, S. (2007). Overview of total least squares methods. *Signal Processing*, (87), 2283-2302.
- [10] Del Rio, J.E.F., Sarkar, T.K. (1996). Comparison between the Matrix Pencil Method and the Fourier Transform Technique for High-Resolution Spectral Estimation. *Digital Signal Processing*, (0011), 108-125.
- [11] Robenack, K., Einschke, K. (2011). On generalized inverses of singular matrix pencils. *Int. J. Appl. Math. Comput. Sci.* (21)1, 161-172.
- [12] Leonowicz, Z. (2006). *Parametric methods for time-frequency analysis of electric signals*. Publishing House of the Wrocław University of Technology.

- [13] Xiang-Gen Xia (2000). Discrete Chirp-Fourier Transform and Its Application to Chirp Rate Estimation. *IEEE Trans. Signal Proc.*, 48(11).
- [14] Borkowski, J., Mroczka, J. (2010). LIDFT method with classic data windows and zero padding in multifrequency signal analysis. *Measurement (London)*, 43(10), 1595-1602.
- [15] Marple, S., Lawrence, J. (1987). *Digital Spectral Analysis*. Englewood Cliffs, NJ: Prentice-Hall.
- [16] Zielinski, T.P. (2005). *Digital Signal Processing – From Theory to Applications*. WKL, Warsaw, Poland. (in Polish)
- [17] Borkowski, J. (2011). Continuous and discontinuous linear approximation of the window spectrum by least squares method. *Metrology and Measurement Systems*, 18(3), 379-390.
- [18] Standard IEC 61000-4-30 (2008) – Testing and measurement techniques – Power quality measurement methods.
- [19] Standard EN 50160 (2010) – Voltage characteristics of electricity supplied by public distribution networks.
- [20] Standard IEC 61000-4-7 (2009) – Testing and measurement techniques – General guide on harmonics and interharmonics measurements and instrumentation, for power supply systems and equipment connected thereto.