

A NEW DIAGNOSING METHOD OF THE INTERNAL STRUCTURE OF THE TITANIUM FAN OF A JET ENGINE WITH LASER ULTRASONICS

Paweł J. Swornowski

Poznan University of Technology, Faculty of Mechanical Engineering, Institute of Mechanical Technology, pl. M. Skłodowskiej-Curie 5, 60-965 Poznan, Poland (✉ swornowski@wp.pl, +48 61 665 3595)

Abstract

Advanced metallic material processes (titanium) are used or developed for the production of heavily loaded flying components (in fan blade construction). The article presents one process for diagnosing the blade interior by means of laser ultrasonography. The inspection of these parts, which are mainly made of titanium, requires the determination of the percentage of bonded grain sizes from around 10 to 30 μm . This is primarily due to the advantages of a high signal-to-noise ratio and good detection sensitivity. The results of the research into the internal blade structure are attached.

Keywords: Non Destructive Testing (NDT), laser ultrasonic, titanium fan, aerospace.

© 2011 Polish Academy of Sciences. All rights reserved

1. Introduction

There can be no doubt that the aerospace industry is a motor for new methods of measurement and diagnosis. New revolutionary plane constructions such as the huge passenger liner Airbus A380 have led to the exploitation of new constructional materials (especially carbon and glass composites) in order to reduce the mass while keeping the strength of construction. The plane's four Rolls-Royce Trent 900 engines with turbo-blowers (Fig. 1a), designed specially for the Airbus, have a very high impact on its mass. In the engines, the need to reduce the mass led to the application of new blade technology designed with the appropriate patent (Fig. 1b). The idea was to connect two titanium plates just at their edges. In between the plates, pressured air is introduced, resulting in their convex shape. The entire process takes place in a special mould which shapes the final blade.

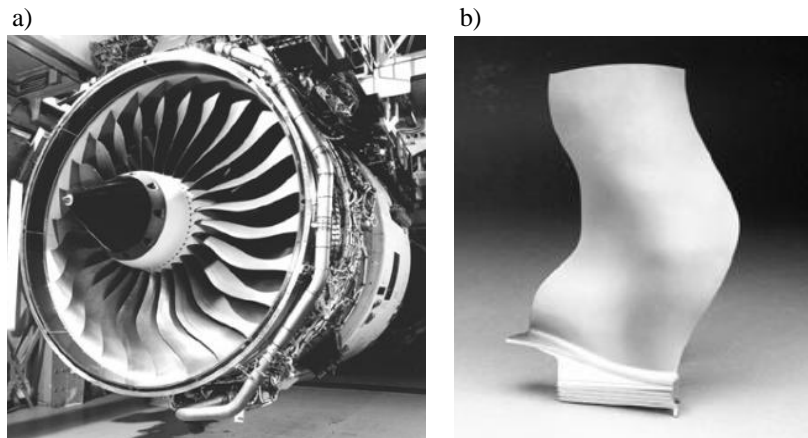

Fig. 1. Rotor of the Trent 900 turbo-blower engine: a) general view, b) single blade (Rolls-Royce).

As a result, an extremely light and strong product is obtained. This solution is a natural continuation of Rolls-Royce's development in construction. Previously, various kinds of filling materials were utilised in the blades of turbo engines, e.g. in the popular RB-211 type engine [1-2]. Those constructions were also empty, but were reinforced with structures similar to a honeycomb (Fig. 2). The new blade for the turbo engine shown in Fig. 1b has a complicated shape in order to increase its effectiveness. To check its conformity with the dimensions specified in documents, a Coordinate Measuring Machine (CMM) is employed. As a result, data concerning the accuracy of the CMM will be obtained.

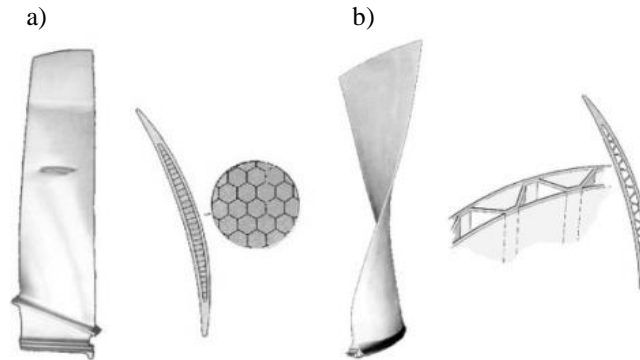

Fig. 2. Examples of blade constructions with armour: a) honeycomb, b) openwork construction.

In the case of aeroplane engine blades, the structure is crucial, and not only the external, but also the inner structure. While an engine is working, the blade is exposed to huge forces that are even able to destroy the plane. Hence, the measuring method should also be able to reveal some defects in the blade's inner structure, such as air bubbles or micro cracks. If such defects are not detected, breakdown could lead to damage to the whole engine, as well as to the airframe. Unfortunately, the new technology discussed above also increases the possibility of defects appearing in the area where titanium plates are joined (Fig. 3). Defects should be detected in the production process, because afterwards, during use, they only increase and may lead to a catastrophe.

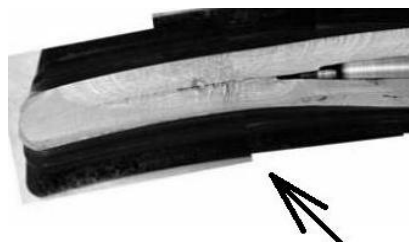

Fig. 3. Examples of damage in the joint of 3 mm-thick composite plates (Rolls-Royce).

2. Choice of diagnostic method

Today, three major families of defect detection technology are in use in the aerospace sector: radiography (X-ray), shearography, and ultrasonics. For metallic parts (steel, titanium), all of these three solutions may work, but each of the technologies excels in one area. Obviously, the diagnosis method should be non-destructive. Bulletin SB72-9660 [3] issued by Rolls-Royce prefers methods based on ultrasonic devices. Other methods, based on X-rays or thermal imaging, are also acceptable. Radiography inspection is one of the oldest non-destructive inspection technologies in the aerospace industry. There are three primary X-ray technologies in use: film, computed radiography and digital radiography (DR). As

companies have become more global, DR has been seen as a huge breakthrough that offers many advantages over standard radiography. A DR system enables the operator to inspect the entire part more quickly. The next method is thermography. In this method a single side of the fan is heated by a heater at ca. 350°C. An infrared camera is used to obtain a reference value of the temperature distribution on the material's surface. Shearography consists in the measurement of in-plane and out-of-the-plane deformations thanks to acquisition from coherent electromagnetic waves between an object and the detector on the inspected surface. Therefore, the choice of the right inspection technology is dependent on a variety of factors and it is a question of understanding the specific technical needs. X-ray diagnosis does not enable a comprehensive analysis. The main problem is caused by the layer of air between the titanium plates of the blade, which sufficiently influences the image to prevent detection of the depth at which the defect is located. On the other hand, thermal diagnosis would require the blade to be heated steadily up to 300°C, which is almost possible in the case of such a structure. It therefore seems that the ultrasonic technique is the most appropriate detection method.

3. The ultrasonic method

3.1. The conventional method

Conventional acoustic methods, special low frequency methods, and the non-contact methods are applied for the defectoscopy of material parts and multi-layered structures. The first group of methods is usually implemented with the help of a liquid for providing acoustic contact between the defectoscope transducer and the turbine blade. The detection of micro cracks with ultrasonic devices has a long history and actually belongs to the most frequently used non-destructive methods. This method has been applied during the last few years to materials such as aluminium and carbon composites.

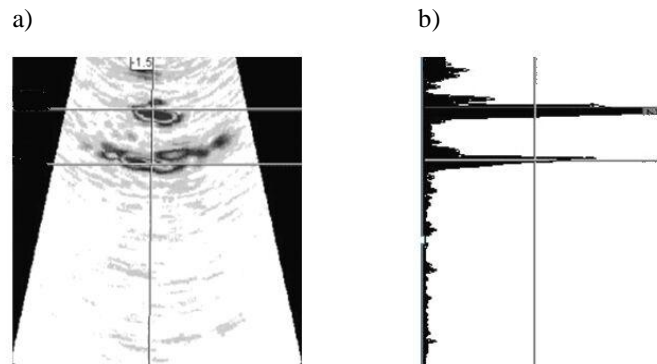

Fig. 4. Example of the ultrasonic image of the analysed blade: a) general view, b) chosen intersection.

Currently, advanced technological materials like titanium are often applied in heavily loaded details in aircraft. Detection aims to reveal hidden defects with dimensions from 10 to 30 μm . The classical ultrasonic method is excellent in the case of uniform details without any empty spaces inside. Here we deal with two different measurement conditions determined by the construction of the blade with empty space between the plates. A typical ultrasonic device would be fooled by the interference of the signal in the empty space of the blade and would provide inadequate measuring results. Fig. 4 presents a measurement using a typical device. Although the defect can be seen here (the dark spot above the horizontal line in the Fig. 4a), its dimensions appear to be much larger than in reality. That may be caused by interference

phenomena in the inner empty space of the blade (the dark area near the lower horizontal line). The inner structure in the intersection shown in the Fig. 4b can be seen a little better. The references are the two “peaks”. The upper peak corresponds with the detected defect, while the other peak corresponds with the empty space filled with pressurised air. It may be stated that such a diagnostic method enables the location of possible defects, although accuracy is far from perfect. The interpretation of such results requires appropriate experience.

3.2. The laser-ultrasonic method

Laser-ultrasonics uses two lasers, one with a short pulse for the generation of ultrasound and another one, long pulse or continuous wave, coupled to an optical interferometer for detection. Laser-ultrasonics is a technique that combines the advantages of both optical and ultrasonic sensing. The technique also features a large detection bandwidth, which is important for numerous applications, particularly small-defect detection and material characterization. The ultrasonic method combined with a laser is a non-contact and non-destructive method, able to be applied to the surfaces of complicated form [4-6]. Depending on the laser beam and its interaction with the material being examined, the ultrasonic waves can be generated in a wide range of frequencies up to the hypersonic range. The rapid development of this method followed the introduction of new constructions of lasers able to generate very short but highly repeatable pulses. Most older solutions generated pulses of a few tens of a nanosecond, while in reality a small defect could be shorter than the typical ultrasonic wavelength. Hence, this led to the application of higher frequencies in the range from 50 to 150 MHz. Along with the frequency, the noise-to-signal ratio increased, resulting in improved sensitivity of measurement. Composition and microstructure influence ultrasonic wave propagation, then ultrasonic characterization of moulding conditions affecting materials is possible with lasers. Furthermore, in such systems it is possible to place a blade on a moving table for examination. As a result, the laser beam may be directed in two axes in such a way as to enable the entire surface of the blade to be examined. The scheme of the whole diagnostic system based on laser ultrasonic is presented in Fig. 5. One of the key elements of the system is the Nd:YAG ($Y_3Al_5O_{12}$) laser, which generates a portion of energy onto the surface of the titanium blade being examined. The active medium in the laser is Yttrium Aluminium Garnet, an artificial crystal, sometimes with admixed ions of neodymium Nd^{3+} . This laser should be of high power, because the sensitivity increases as power increases. Moreover, it should not contribute any additional noise to the main signal. High power is required particularly when the examined surface absorbs much of the ultrasound beam. The pulse should last long enough to enable the whole signal to be read. In the industrial solution, the signal lasts between 10 and 100 μs . The technology of the Nd:YAG laser enables high multiplication to be reached. Pulses of 1 kW and more are generated, typically lasting 50 μs . The diameter of the laser spot is 50 μm and it is emitted with a frequency up to 150 MHz. The laser beam is absorbed down to the assumed depth of the material. In the locally heated area, some tensions appear and generate waves in the material or just under its surface. In order to detect the reflected signal, the other laser beam (the second laser is also built using Nd:YAG technology – the second harmonic of a 1064 nm wave) lights up the blade surface. The second beam could be steady or pulse in nature, but the pulses should be long enough to enable reading of the whole outgoing ultrasonic signal. The reflected beam is directed to the receiver; in industrial conditions the receiver is the laser interferometric device.

The set-up for the tests is described in Fig. 5. The generation laser is focused on the sample in order to obtain high optical power density for ultrasound generation in the ablation regime.

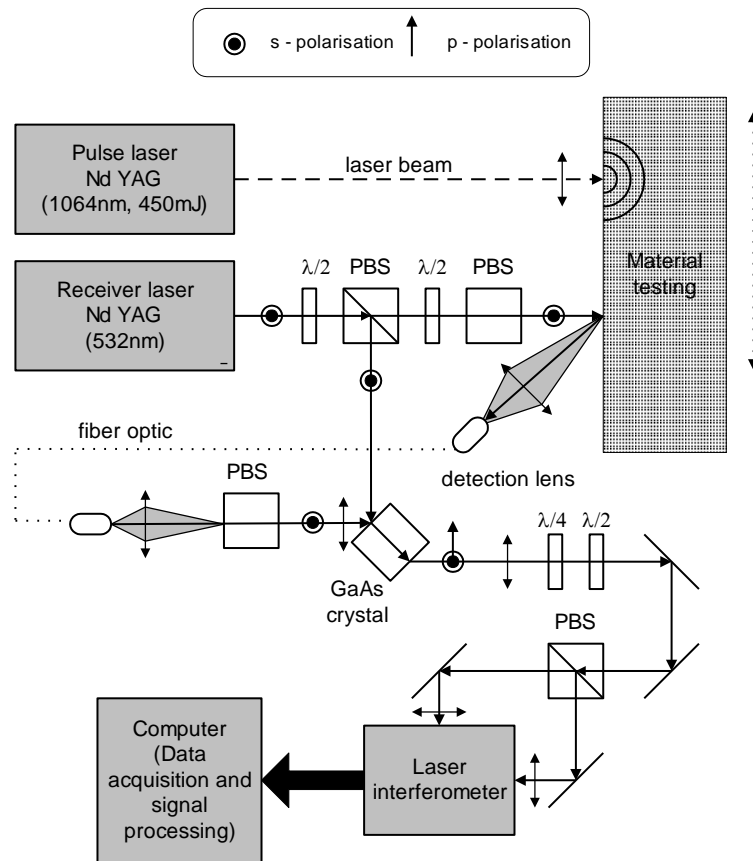

Fig. 5. Laser ultrasonic set-up.

An Nd:YAG laser operating on its basic wavelength of 1064 nm was used for detection of ultrasound. The detection laser is collimated on the sample so that the detection spot diameter is about 1 mm. The light of the detection laser scattered by the sample is collected by a lens and sent to a multi-mode optical fibre. The detection of ultrasonic waves is based on optical interferometry. For detection of ultrasonic waves, a confocal Fabry-Pérot interferometer uses light reflected from the surface of the material, and detects changes in the frequency of reflected light. The interferometer output signal depends on the velocity of waves arriving at the material surface using the Doppler effect. In the research a two-frequency detection laser was used. The frequency bandwidth of the measurement system ranged from 1 to 35 MHz. Typically, low frequencies correspond to long path lengths in the interrogated material (a few mm), while high frequencies probe shorter distances (a few μm), commensurate with the size of the monitored cracks. The two laser beams were focused onto the surface of the specimen at about the same location. The generation and detection spot sizes were 0.1 mm and 0.3 mm, respectively. The step size of the scan was 0.1 mm. The laser beam was moved by a computer-controlled translation mirror stage with step accuracy of 80 nm and a velocity accuracy of less than 1 mm/s. A computer-controlled shutter was used for turning the beam on and off. The laser was mounted into a holder whose vertical and horizontal position was controlled by two stepper motors. They were used in order to perform steps of 0.1 mm in both directions and thereby enabled vertical and horizontal scanning. The measurement grid ultrasonic signal was collected, digitized and stored in the computer.

The sensitivity of ultrasonic detection is reduced by crack-closure. Fatigue crack nucleation and growth are usually accompanied by substantial plastic deformation. Fatigue cracks are usually initiated by small geometrical irregularities or material inhomogeneities that produce sharp local stress concentrations. However, the sensitivity of the technique

depends on a great variety of material parameters, which should all be considered carefully and incorporated into the optimization of the procedure.

3.2.1. Energy emission in the material

The ultrasound waves generated can be divided in two categories: bulk and surface acoustic waves (Fig. 6). The scattering of acoustic waves and therefore the detection limit for solitary defects is directly related to the wavelength. Ultrasound waves can be excited using a short-pulse laser. Standard ultrasound waves are excited depending of the amount of energy deposited in the material [7-9]. The amplitude of the different waves depends on the laser energy and the absorption behavior of the material. High frequency and therefore short wavelength waves can be used to detect very small defects like cracks in the lattice structure or larger defects like delaminations on or close to the surface of the specimen. The propagation of the waves depends on the material's constants and its inherent structure and is often highly non-linear, showing dispersion, polarisation and damping.

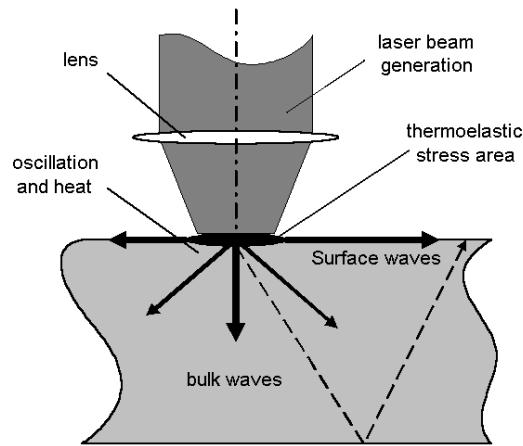

Fig. 6. Non-destructive excitation of different ultrasound waves in a material.

A pulse laser sends single or multiple pulses of a controlled magnitude, which are absorbed by the material surface and generate local heating. Thermoelastic excitation is produced and in turn induces ultrasonic surface wave propagation in the material. It is the detection and capture of this thermoelastic response that delivers information regarding the state of the specimen. An alternative approach is laser tapping, which consists in focusing the thermal stresses produced by the laser in order to cause a lifting and bending effect, and so induce vibration of a potentially disbonded layer. The laser beam penetrates into the material and the laser energy transforms into oscillations and heat. The differential equation for thermal conduction for temperature T is as follows:

$$\frac{\partial T}{\partial t} - \alpha \Delta T = \frac{\varepsilon}{\eta \tau}, \quad (1)$$

where:

α – thermal diffusivity [m^2/s], η – density [kg/m^3], λ – thermal conductivity [W/mK], τ – specific heat capacity [J/kgK], ε – heat source, absorbed power density [W/m^3].

Solutions for sources where the absorbed power density is periodic with a modulation frequency ω :

$$T = T_{amb} + T_{stat} + v(x), \quad (2)$$

where:

T_{amb} – ambient temperature [mK], T_{stat} – static temperature rise [mK], ν – temperature oscillation [mK].

For an absorbed power density F at the surface of a semi-infinite material a solution (for a one-dimensional (x) solution) is:

$$\nu(x) = \frac{F}{\sqrt{\eta\tau\lambda}} \times \frac{1}{\sqrt{\omega}} \times e^{-\frac{\pi}{4}} \times e^{-\frac{x}{\theta}} \times e^{-\frac{x}{\theta}}, \quad (3)$$

where θ – thermal diffusion length [m].

Thermal diffusivity α describes the spatial/temporal propagation of the heat. The pressure induces a virtual vibration displacement signal:

$$\Delta s_{opt} = s \times \Delta n, \quad (4)$$

where:

Δ_{opt} – optical path length difference, s – geometrical path length difference, Δn – refractive index difference.

3.2.2. The F-SAFT procedure

Ultrasonic testing is widely used for detecting, locating and sizing flaws in many applications. In the conventional ultrasonic method, an improvement of the lateral resolution and signal-to-noise ratio is achieved by focusing the acoustic field with lenses or curved transducers or by using a computational technique that basically consists of performing the focusing numerically. Originally developed in the time domain, SAFT (Synthetic Aperture Focusing Technique) can be beneficially implemented in the frequency domain (F-SAFT) [10-12]. F-SAFT is based instead on the plane wave decomposition of the measured ultrasonic field at the surface (angular spectrum approach) and then utilizes a back propagation algorithm to find the field in any plane inside the material.

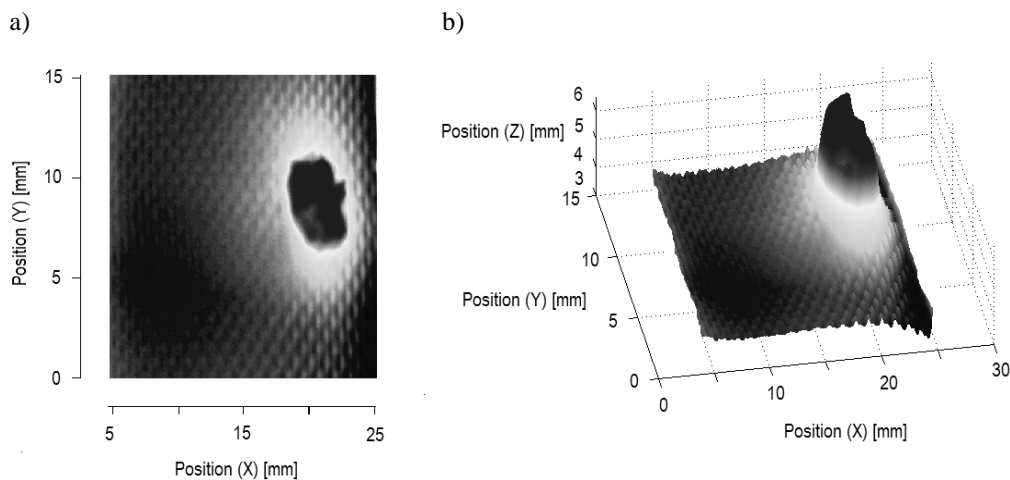

Fig. 7. Example C-scan (20x15 μm) of 35 J impact damage on the material: a) 2-D, b) 3-D.

Today, the F-SAFT method is investigated for imaging simulated and real defects in several applications such as the detection of inclusions in steel slabs, visualization cracks and delaminations along curved interfaces. One method is the frequency domain SAFT (F-SAFT), whereby data processing is performed in a 3-D Fourier space using the angular spectrum method [13, 14] (Fig. 7).

4. Examples of the results

For the blades of the type described above, diagnosis is generally performed in the two areas shown in Fig. 8 and marked as A and B. In Fig. 9, the initial image of the area C is shown with minimal resolution. This produces good visible joints on the right and on the left sides of the two titanium plates.

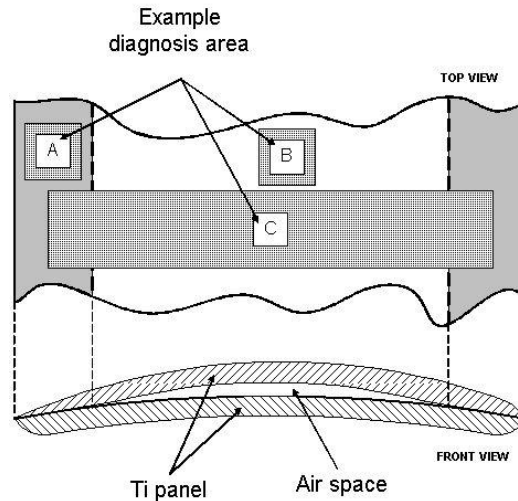

Fig. 8. Simplified intersection of the blade.

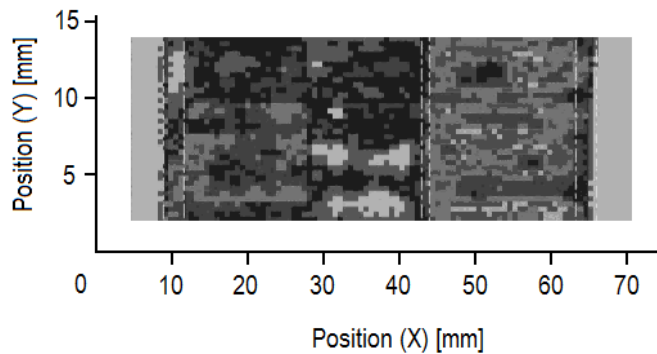

Fig. 9. Initial C-scan of area C in 2-D.

Figs. 10 and 11 present images of the joints of two titanium plates (marked A in Fig. 8). The defect is located inside the upper plate in the middle of its thicker section. When the depth is assumed to be 1.5 mm, the ultrasonic beam reveals that defect. When the sounding depth is over 3 mm, i.e. below the plates' joint, the contrast of the image is much worse. However, in both cases it is possible to analyze particular intersections with a special program and to identify the location of the defect (high peaks in the graph). When the assumed depth is in the range from 3 to 6 mm (the limits of the two titanium plates' dimensions), the ability to detect the defect does not decrease significantly. Hence, it seems the most probable that the main source of the noise is the joint of the two plates (Fig. 8). One problem, however, is detecting the edge of the blade, because both plates decrease their thickness in the orthogonal intersection. Obviously, this is caused by the aerodynamic properties of the blade. Nevertheless, access to the technical documentation where the dimensions and the thickness change in certain places is required.

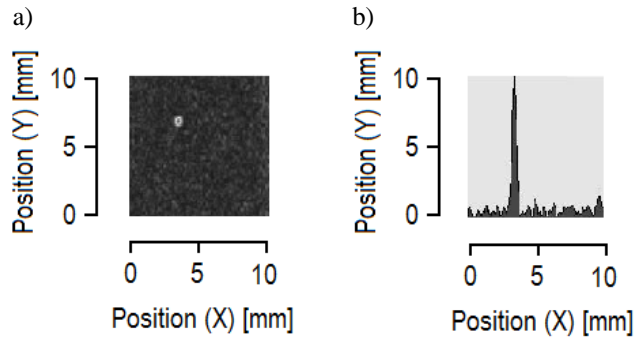

Fig. 10. Laser-ultrasonic 2-D C-scan (a) with an assumed sound depth of 1.5 mm and profile (b).

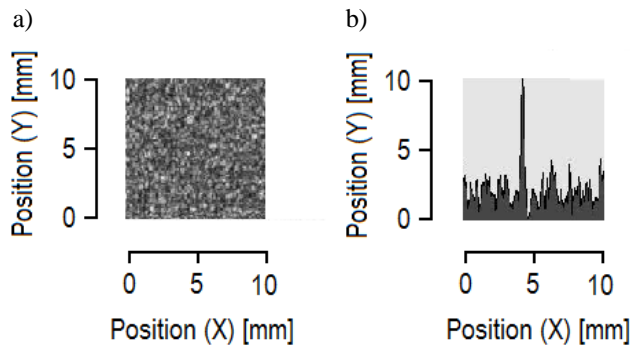

Fig. 11. Laser-ultrasonic 2-D C-scan (a) with assumed sound depth over 3 mm and profile (b).

Fig. 12 presents the diagnosis of the area marked B in Fig. 8, i.e. in the place where the empty space between two titanium plates has the largest impact on the measurement results. When the depth is set to 1.5 mm (compared to a plate thickness of 3 mm), the device perfectly locates the inner defect with its true dimensions. When the depth is increased to over 3 mm, noise appears in the image, although the defect located in the upper part of the titanium plate remains detectable. Also, the image quality does not worsen substantially due to the empty space between the connected plates of the blade. Furthermore, the joint between the blade and the rotor should be examined. Unfortunately, the shape of the blade in that place makes it difficult to conduct the measurement with laser-ultrasonics. Therefore, the measurement must be performed at a certain angle to the surface.

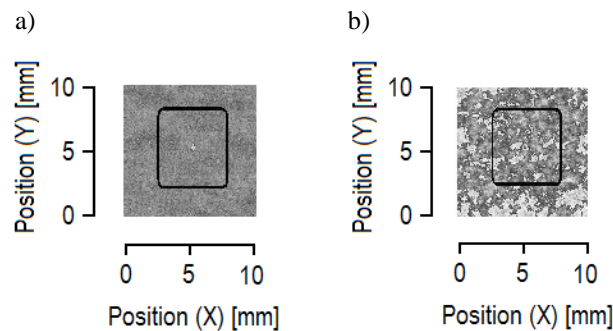

Fig. 12. Laser-ultrasonic 2-D C-scan with assumed sound depth: a) 1.5 mm, b) over 3 mm.

5. Limitations of the method

Exceeding certain border-parameters of the penetration can damage the material being analysed. High power pulsed laser interaction with matter yields to very high amplitude

pressure loading with a very short duration, and produces a strong short shock wave into the solid substance [15-17]. When a laser pulse of short duration and high density of power is focused on the surface of a solid target, the laser energy absorption of the target surface generates plasma, whose expansion induces a shock wave. Theoretical studies primarily establish scaling laws connecting the incident laser intensity with the shock pressure; they are parameterized by the characteristics of the pulse (wavelength, pulse duration, nature of material, dimension of the focal spot). The laws (based on experimental measurements of pressure according to various methods) are defined on ranges of incident intensity and very often associated with the specific characteristics of the irradiation.

6. Conclusions

Each method presented has its own merits and disadvantages. Typical ultrasonic diagnosis requires application of a liquid or other medium like gel placed on the detail being examined. A large amount of the measurement data requires complicated interpretation. Furthermore, the method is not effective when a porous inner surface is measured, or the surface measured is very complicated. The X-ray method does not provide information on the depth at which the defect appears. When the detail is of complicated geometry, the identification and interpretation of the defect is not easy. Substantial problems appear in identification of the micro-cracks in the structure. Also of great importance is the high cost of safe application of this method. It seems that the universal method of inner defect detection is thermal diagnosis. It does not require initial preparation of the surface, it is a non-contact and non-invasive method, it does not emit any kind of harmful rays and it is a fully mobile method. The only difficulties in application relate to the uneven distribution of heat on the composite surfaces.

The method using a laser and ultrasonic measurement is the most promising. It is non-contact, non-invasive and it could be applied during the production process and exploitation of the turbine blade details. The advantage of the method is its ability to produce a quick and successful diagnosis, as well as automation of the process. However, the most important merit is the improvement of the defect image even after the plate thickness has been overcome. Even though interference noise appears, the defect is still detectable. The special calculating algorithm based on the F-SAFT is helpful in achievement of the result. Additionally, the program enables detection in any intersection and in places where inner defects could be hidden. In fact, the defects are seen much better on a 15.4" LCD screen. The receiver laser is also works in the second harmonic. This solution is not optimal (noise and the short coherence way). Therefore, it is possible to recommend the application of the laser ultrasonic method (despite these technical limitations) during various fatigue tests in the aerospace industry.

References

- [1] Boyer, R.R., Briggs, R.D. (2005). Titanium cost reduction strategies for Boeing Aircraft. *Materials Forum*, 29.
- [2] Examination of a Failed Fan Blade Rolls-Royce RB211, Trent 892 Turbofan Engine (2001). *Technical Analysis Report*, Australian Transport Safety Bureau (ASTB), 8.
- [3] Bulletin SB72-9660 (2001). Rolls-Royce.
- [4] Blackshire, J.L. (2004). Interferometric and Holographic Imaging of Surface Wave Patterns for Characterization of Material Degradation. *Eds. Meyendorf, Nagy, and Rokhlin, Chapter 4 in Nondestructive Materials Characterization*, Springer.
- [5] Monchalín, J.-P. et al. (1998). Laser-ultrasonics: from the Laboratory to the Shop Floor. *Advanced performance materials*, 5, 7-23.

- [6] Scruby, C.B., Drain, L.E. (1990). *Laser Ultrasonics: Techniques and Applications*. Adam Hilger, 136-141.
- [7] Ihara, I., Takahashi, M., (2008). Laser-Ultrasonic Monitoring of Temperature Distribution of Material Surface during Heating. *Mat. of 1st International Symposium on Laser Ultrasonics: Science, Technology and Applications*, Montreal, Canada, 188-192.
- [8] Mizutani, K. et al. (2006). Measurement of Temperature Distribution using Acoustic Reflector. *Jpn. J. Appl. Phys.*, 45, 4516-4520.
- [9] Takahashi, M., Ihara, I. (2008). Ultrasonic Monitoring of Internal Temperature Distribution in a Heated Material. *Jpn J. App. Phys.*, 47, 3894-3898.
- [10] Blouin, A. et al. (1998). Improved Resolution and Signal-to-Noise Ratio in Laser-Ultrasonics by Synthetic Aperture Focusing Technique (SAFT) processing. *Optics Express*, 2, 531-539.
- [11] Lévesque, D. et al. (2002). Performance of Laser Ultrasonic F-SAFT Imaging. *Ultrasonics*, 40, 1057-1063.
- [12] Lévesque, D. et al. (2002). Laser-Ultrasonic Inspection of Surface-Breaking Cracks in Metals using SAFT. *Mat. of IEEE Intern. Ultras. Symp. Proc.*, New York, 732-735.
- [13] Mayer, K. et al. (1990). Three-dimensional Imaging System Based on Fourier Transform Synthetic Aperture Focusing Technique. *Ultrasonics*, 28, 241-255.
- [14] Busse, L.J. (1992). Three-Dimensional Imaging Using a Frequency-Domain Synthetic Aperture Focusing Technique. *IEEE Transactions on Ultrasonics, Ferroelectrics, and Frequency Control*, 39, 174-179.
- [15] Koenig, M. et al. (1995). Relative Consistency of Equations of State by Laser Driven Shock Waves. *Phys. Rev. Letters*, 12(74), 45-49.
- [16] Bolis, C. et al. (2007). Physical Approach of Adhesion Test using Laser Driven Shock Wave. *J. Phys. D: Appl. Phys.*, 10(40), 3155-3163.
- [17] Boustie, M. et al. (2008). *Laser Shock Waves: Fundamentals and Applications*. *Mat. of 1st International Symposium on Laser Ultrasonics: Science, Technology and Applications*, Montreal, Canada, 32-40.