

Paweł SOBCZAK

Department of Automotive Vehicle Construction
Faculty of Transport, Silesian University of Technology
ul. Krasińskiego 8, 40-019 Katowice
**Corresponding author. E-mail: pawel.sobczak@polsl.pl*

**PROCEDURE OF LINEAR DECIMATION IN CAR SUSPENSION
DIAGNOSIS**

Summary. In admission this paper presents most popular car suspensions. The main part of article show capabilities of uses of linear decimation in car suspension diagnosis.

**ZASTOSOWANIE PROCEDURY LINIOWEJ DECYMACJI
W DIAGNOZOWANIU ZAWIESZEŃ SAMOCHODOWYCH**

Streszczenie. Na wstępie artykułu zaprezentowano najpopularniejsze zawieszenia samochodowe. Główną część artykułu stanowi przedstawienie możliwości wykorzystania liniowej decymacji w diagnozowaniu zawieszeń samochodowych.

1. INTRODUCTION

Car vehicles are very compound and complicated mechanical matches. Personal cars are the biggest and most popular group. Personal car is built from about 3 thousand parts.

Underway vehicle is subjected by many loads which commonly becomes from road inequality. This loads most often shows as vibrations. Vibrations have an influence on vehicle constancy & convenience of use, they also can be very dangerous for users. Vibrations with too big amplitude or concrete frequency may cause discomfort, tiredness and even loss of health.

Suspension is sub-assembly which should decrease of vibration interaction. Group of elements which connect tires with frame or car body is known as suspension [7]. Very different, requiriement and contradictory tasks are given to car suspension. The most important of them are [4]:

- transmitting of loads from tires to frame or car body,
- counteraction of vehicle dynamic press on road,
- counteraction lateral tilts.

Already in use is range of complicated construction suspensions types.

2. SUSPENSION

Suspensions can be split on 3 groups [4]:

- 1) dependent suspension,
- 2) independent suspension,
- 3) with jointed control arms.

Today, dependent suspensions aren't mounted in underway vehicles. Majority presently applicable suspensions are independent, which means that each wheel is merged with frame or car body independently. Suspensions can be divided into [4]:

- a) suspensions with double transverse arms,
- b) suspensions with lower radius arm,
- c) suspensions with semi trailing arms,
- d) suspension with control arms joined by torsion beam,
- e) multilever suspensions (ex. Mercedes),
- f) McPherson strut suspension.

Nowadays, the most popular is McPherson strut suspension which is shown in fig. 1 [9].

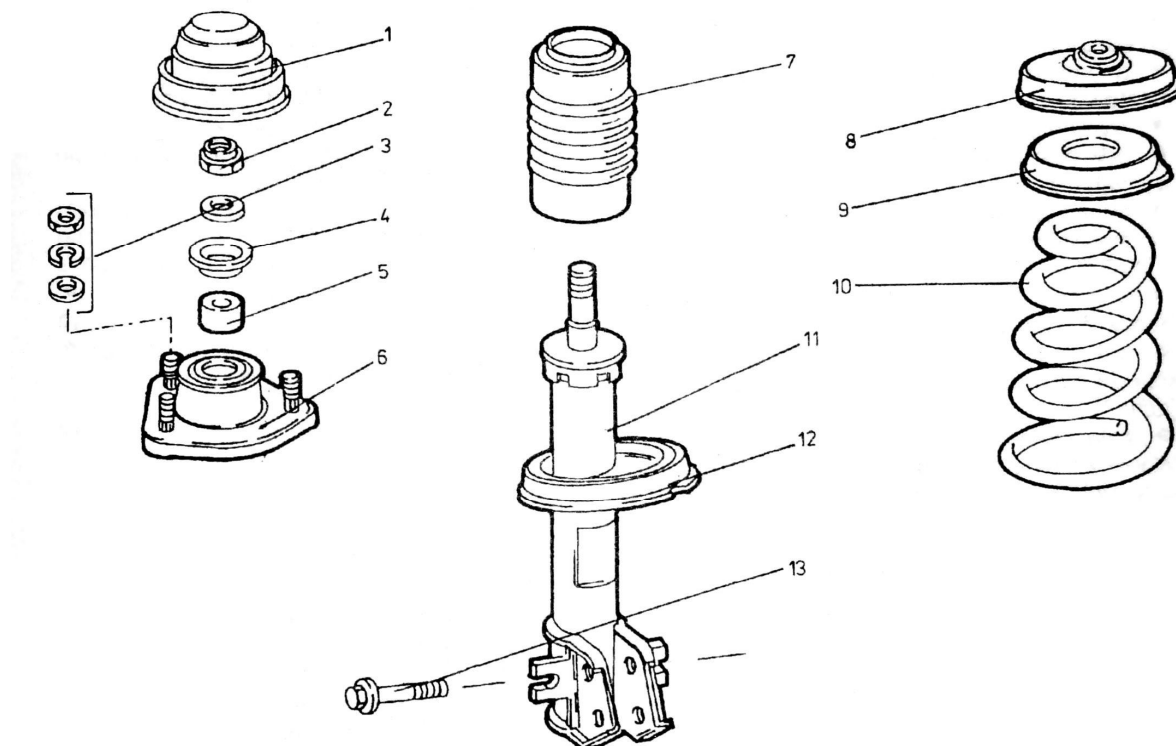

Fig. 1. McPherson strut suspension. Elements of front suspension: 1 – cap, 2 – Shock absorber rod nut, 3 – rods & plater of high mount link, 4 – banking pad, 5 – sparing sleeve, 6 – high mount complete link, 7 – rubber bumper, 8 – spring high pan, 9 – high pan plate, 10 – suspension spring, 11 – Shock absorber, 12 – spring low pan, 13 – screwbolt which mount strut to stub axle

Rys. 1. Zawieszenie McPhersona

Diagnosing of suspension mostly is carried as research on real objects with programmed faults. One of the major tasks of suspension is decrease of vibration interaction. Elastic elements like a rubber or rubber elastic joint are used for this. Tires also have influence on vibration damping but shock absorbers are the basic elements used for damping.

3. SHOCK ABSORBER

Shock absorber is an element with highly damping characteristic. Presently, in use are shock absorbers with high nonlinear characteristic are. This nonlinear characteristic can be made by application of overflow valves. Example characteristics are shown in fig. 2 [5].

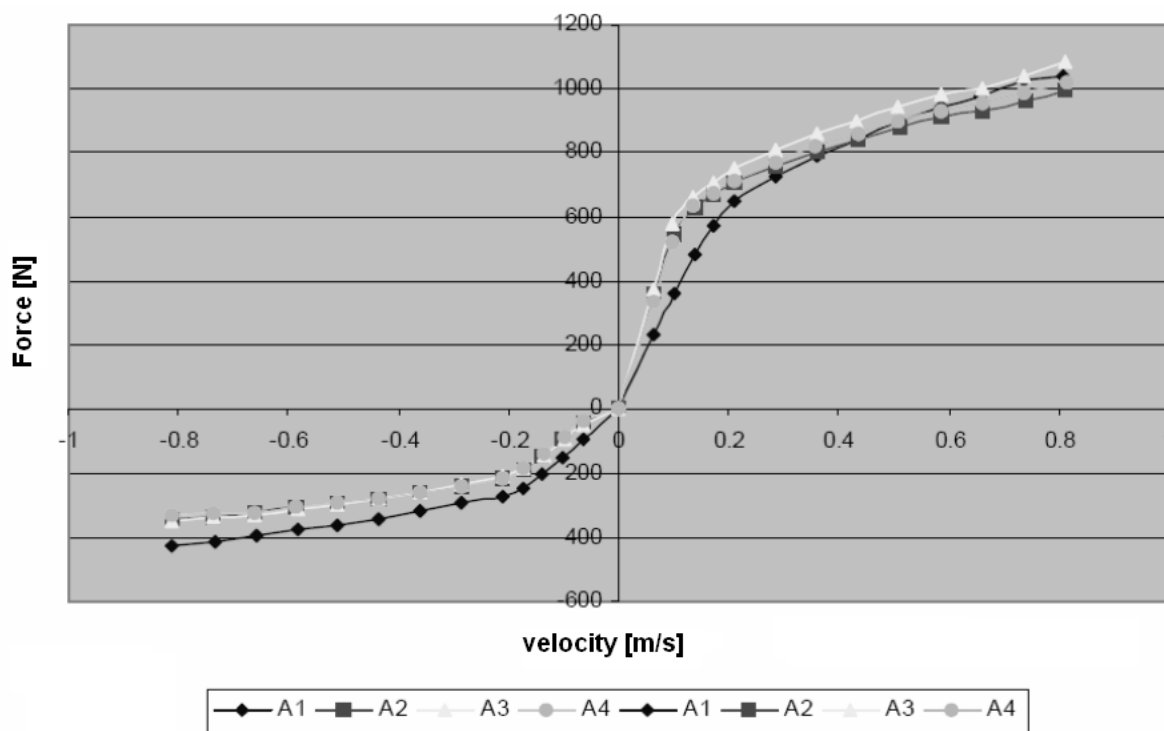

Fig. 2. Dumping characteristic of new schock absorbers
 Rys. 2. Charakterystyka tłumienia nowych amortyzatorów

Schock absorbers can be divided in view of structure on [4]:

- a) one pipe non-pressure,
- b) one pipe high-pressure,
- c) double pipes low-pressure,
- d) double pipes non-pressure.

Example construction of shock absorber is show in fig. 3 [8].

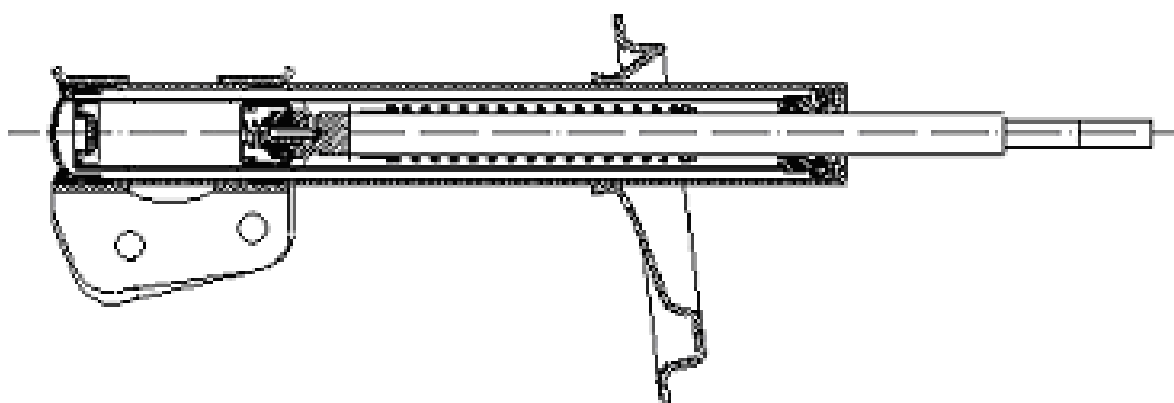

Fig. 3. Shock absorber construction
 Rys. 3. Budowa amortyzatora samochodowego

Wide and contradictory task are given on shock absorbers. Shock absorbers must:

- a) counteraction to vertical jumps of car body,
- b) decrease of car body acceleration.

4. SHOCK ABSORBERS RESEARCH

Shock absorbers research can be split on:

- a) research of shock absorbers dismantled from cars,
- b) research of shock absorbers mounted in cars.

Research of shock absorbers dismantled from cars are made on indicate stand which were described in [1, 4, 8]. We can get velocity and work diagrams on it.

Research of shock absorbers mounted in cars can be split on:

- a) forced vibration method,
- b) free vibration method,
- c) without measuring position.

All of them were described in [1, 4].

Vibration process, can be analyze with time-frequency analysis. The most popular analysis are:

- a) Short Fast Fourier Transform (SFFT),
- b) Wigner-Villes Transform (WVD),
- c) Wavelet Transform.

In research, decimation was used as a new diagnostic method. Decimation process and its advantages were widely described in literature (ex. [3, 6]). Vibration processes which are in shock absorbers have non-stationary character and classic Fourier transform don't give us any diagnostic information. According to [10] non-stationary signals are random signals which don't have the same values of basic statistic parameters in their realization set for each time moment (ex. mean, variance, etc.). Thus, in [3] was suggested to use linear decimation. Linear decimation relies on deletion of samples which are proportional to cycle increase and it leaves invariable number of samples on cycle [1]. This process change non-stationary vibration signal on quasi-stationary and classic Fourier transform can be used for diagnosing this type of signals.

5. RESEARCH

Research was carried according to schema which is shown in fig. 4.

In the beginning shock absorbers were accommodated for research by modifying from integral on collapsible construction. Measurement track was also adapted. Research was performed for wide range of shock absorbers with specially programmed defect which were: fluid leaking, piston wad defect and some of both defects. Research was relied on obtained vibration signals on harmonic stand [1]. Signals were analyzed in MATLAB.

Obtained vibration signals consist of following period:

- 1) entry on stand,
- 2) harmonic stand turn on and increase linear frequency to 21 [Hz],
- 3) remaining under extortion,
- 4) harmonic stand turn off and passage of vehicle by all resonance frequencies.

Signals were recorded by 2 accelerometers. They were put on control arm and on top mount of shock absorber. Places of mounting the sensors are shown on fig. 5 [2].

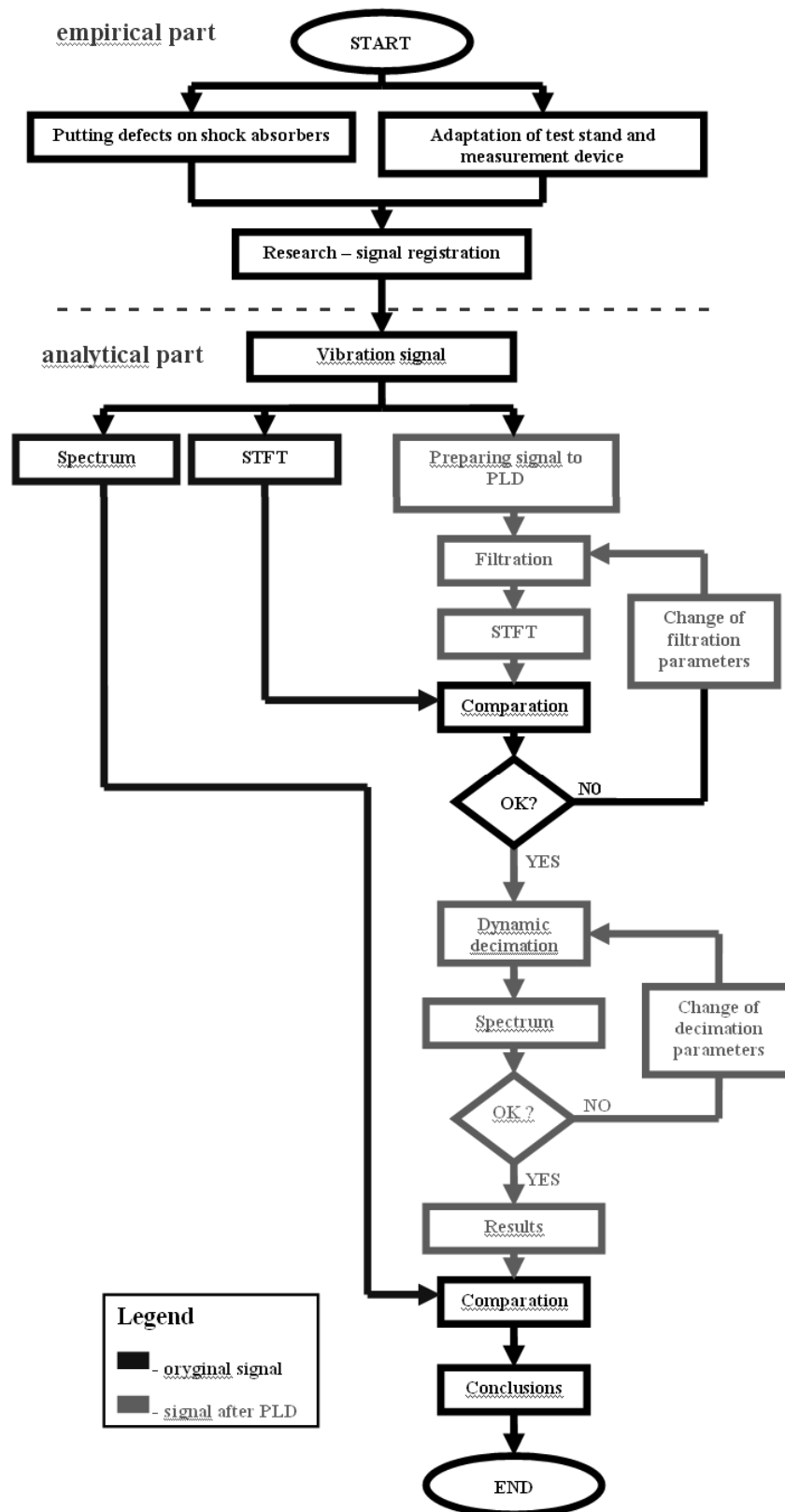
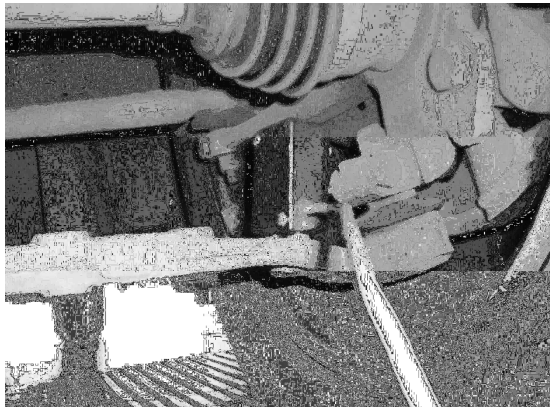

Fig. 4. Research schema

Rys. 4. Schemat przeprowadzonych badań



Unspring mass sensor
Czujnik mas nieresorowanych



Spring mass sensor
Czujnik mas resorowanych

Fig. 5. Places of sensors montage

Rys. 5. Miejsce mocowania czujników na elementach pojazdu

Example of vibration diagram is shown in fig. 6.

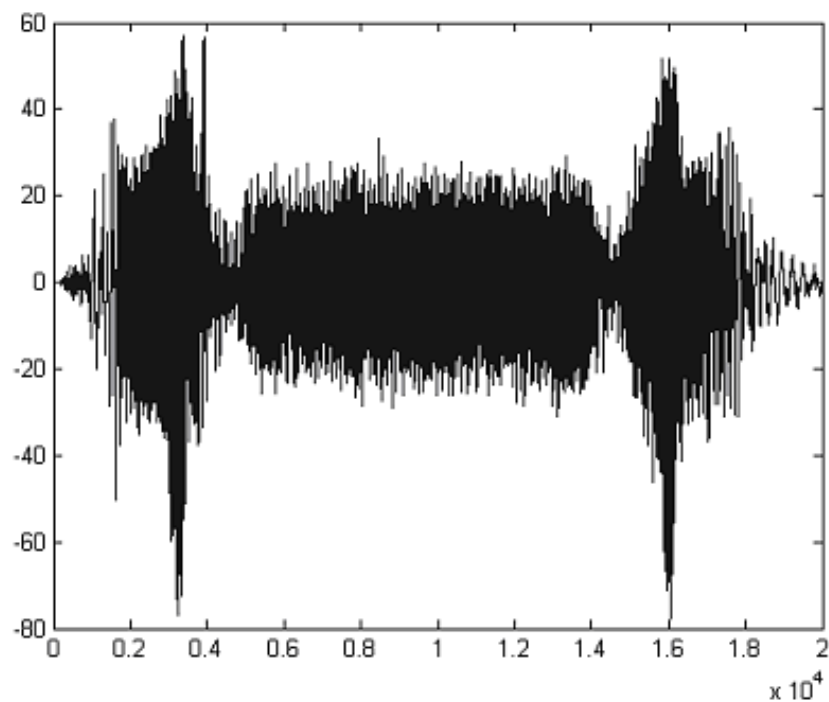

Fig. 6. Recorded vibration diagram

Rys. 6. Zarejestrowany wykres drgań

Gotten signals were filtered in case of aliasing and linear decimation was made. Signals were gotten on spectrum analysis.

6. RESULTS

Wide range of spectrums of vibration signals with programmed defect were given in result. Example spectrums after decimation and without decimation are shown in figure 7.

Shown spectrums are given from shock absorbers with 35% fluid leaking and 2% piston wad waste.

Goten spectrum in case of programmed defect had different place and value of spade.

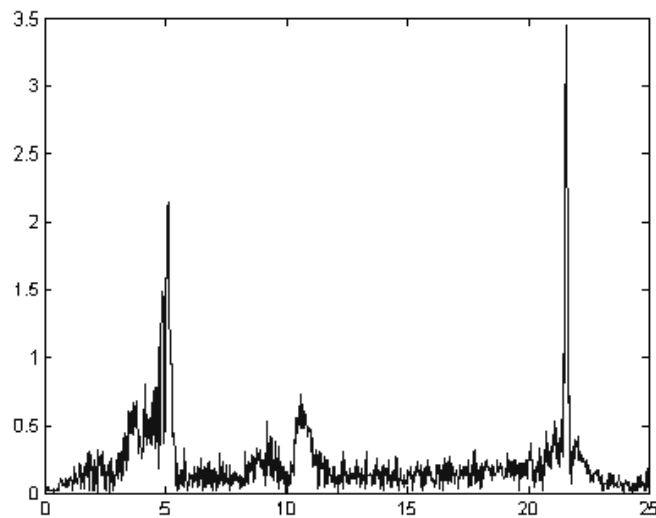

a) spectrum after decimation
a) widmo sygnału po decymacji

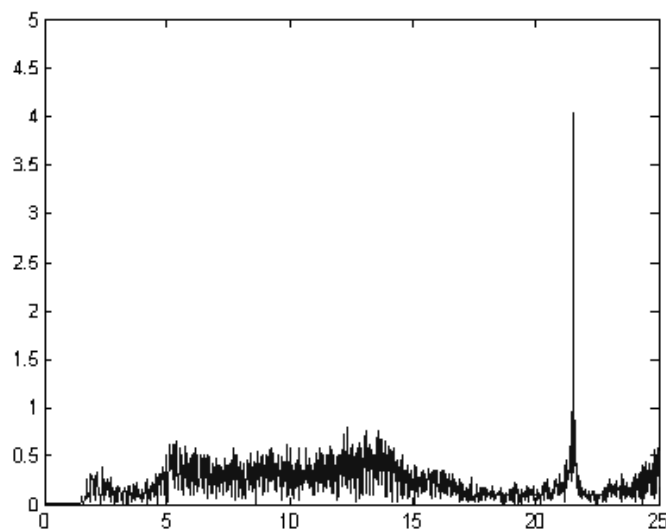

b) spectrum without decimation
b) widmo sygnału bez decymacji

Fig. 7. Spectrum of signal
Rys. 7. Widmo badanego sygnału drganiowego

7. CONCLUSION

Classic Fourier transform is useless in analysing non-stationary signal. Spectrum shows only spade which came from harmonic stand extortion.

Linear decimation allows us to get spectrum which consist of diagnosis information. Resonance frequencies are shown very well in spectrum.

Results of research are only preliminary analyses. Another, more detailed research must be taken in future.

References

1. Burdzik R.: *Rozprawa doktorska: Automatyczne diagnozowanie stanu technicznego amortyzatorów zabudowanych w samochodach osobowych*, Katowice, 2006.
2. Burdzik R., Sobczak P.: *Pola rezonansowe w diagnozowaniu zawieszonych pojazdów samochodowych*, XXXV Jubileuszowe Ogólnopolskie Sympozjum Diagnostyka Maszyn, Węgierska Górka, 2008 (CD).
3. Cioch W.: *Rozprawa doktorska: Sztuczne sieci neuronowe w diagnostyce zagrożeń eksploatacyjnych systemów technicznych*, Kraków, 2002.
4. Gardulski J.: *Bezstanowiskowa metoda oceny stanu technicznego zawieszonych samochodów osobowych*, Katowice-Radom, 2003.
5. Gardulski J., Konieczny Ł., Warczek J.: *Wyznaczanie charakterystyk tłumienia amortyzatorów na stanowisku indykatorowym*, XXXV Jubileuszowe Ogólnopolskie Sympozjum Diagnostyka Maszyn, Węgierska Górka, 2008 (CD).
6. Lyons R.: *Wprowadzenie do cyfrowego przetwarzania sygnałów*, WKŁ, Warszawa, 2006.
7. Orzełowski S.: *Budowa podwozi i nadwozi samochodowych*, WSzP, Warszawa, 1987.
8. Warczek J.: *Rozprawa doktorska: Sygnały drganiowe jako miary diagnostyczne amortyzatorów samochodów osobowych*, Katowice, 2004.
9. Zembowicz J.: *Fiat Seicento*, WKŁ, Warszawa, 2005.
10. Zieliński T.: *Cyfrowe przetwarzanie sygnałów*, WKŁ, Warszawa, 2007.

Received 7.12.2008; accepted in revised form 13.07.2009