

**Damian HADRYŚ\***, **Tomasz WĘGRZYN**, **Michał MIROS**

Silesian University of Technology, Faculty of Transport, Department of Automotive Vehicle Service  
Kraśińskiego St. 8, 40-019 Katowice, Poland

\*Corresponding author. E-mail: damian.hadrys@polsl.pl

## **THE INFLUENCE OF VARIOUS PRESSURES IN PNEUMATIC TYRE ON BRAKING PROCESS OF CAR WITH ANTI-LOCK BRAKING SYSTEM**

**Summary.** In this article has been presented the influence of various pressures in pneumatic tyre of passenger car Fiat Panda 1.3 JTD with anti-lock braking system on chosen parameters of braking process: course of braking deceleration, maximum value of deceleration, braking distances.

## **WPLYW ZMIANY CIŚNIENIA POWIETRZA W OGUMIENIU POJAZDU OSOBOWEGO WYPOSAŻONEGO W ABS NA PARAMETRY PROCESU HAMOWANIA**

**Streszczenie.** W pracy przedstawiono wpływ zmian ciśnienia powietrza w ogumieniu pojazdu osobowego Fiat Panda 1,3 JTD wyposażonego w układ ABS na wybrane parametry procesu hamowania: przebieg opóźnienia hamowania, maksymalna wartość opóźnienia hamowania, droga hamowania.

### **1. INTRODUCTION**

Highway traffic and safety engineers have some general guidelines they have developed over the years and hold now as standards. ABS could be treated as an example of that opinion. An anti-lock braking system (ABS) (translated from German, Antiblockiersystem) is a system on motor vehicles which prevents the wheels from locking while braking. An anti-locking braking system allows the driver to maintain steering control under heavy braking by preventing a skid and allowing the wheel to continue to forward roll and create lateral control, as directed by driver steering inputs. The four-wheel ABS or Anti-lock Braking System is designed to help the driver maintain steering control during hard braking, especially in slippery conditions [1, 2]. Slowing down is one of basic activities of the driver and that process is executed during normal using of the vehicle. Safety of the vehicle and its users depend on the course of the process. Slowing down should be marked by a short braking distance, with undelay reducing of the velocity of the vehicle after running the brake, and moreover should not lose steerability and predictability of the vehicle. Correct course of the braking process depends on some factors such as: technical state of the brake system, stress (pressure) on the brake pedal, state of the road, state of tyres, etc. Moreover course of the slowing down process depends on factors determining the character of the cooperation between wheels and surface of the road. One of those factors is pressure in pneumatic. It is treated that pressure in pneumatic tyre influences work of the anti-lock braking system (ABS).

Control of steerability and braking stability is the main purpose of ABS application. That control could be useful during difficult conditions of the road. ABS application could be also very important while braking with inadequate reactions during braking the car (locking wheels when braking). The car loses steerability and because of that skid, out of control and other events may be very probable. In all conditions ABS prevents wheels blocking, ABS proves steerability of vehicle and ABS reduces going into a skid. Thanks to ABS (even after total and sudden press of the brake pedal) execution of the manoeuvre of pass and avoiding the collision could be treated as possible [3]. Estimation of braking system effectiveness (deceleration) could be analysed by road test decelerometer. Deceleration of braking is one of the quantities describing that process. According to technical regulations the value of maximum car deceleration should achieve at least  $5 \text{ m/s}^2$ . However values of time of deceleration increase and the length of the braking distance haven't been determined.

Figure 1 shows theoretical course of the braking deceleration. Vehicles braking from the same velocity of the driving. The vehicle No3 cannot be admitted to traffic because it doesn't reach value of  $5 \text{ m/s}^2$  and it obtains the longest braking distance. Vehicles No1 and No2 could be admitted to traffic. Deceleration of vehicle No2 and vehicle No3 is higher than  $5 \text{ m/s}^2$ . However the basic dissimilarity exists between this courses.

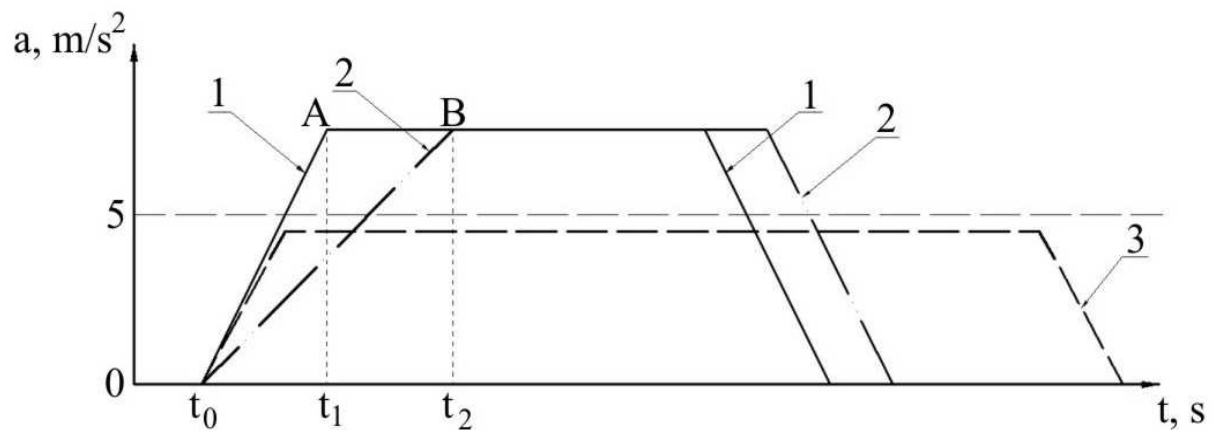

Fig. 1. Theoretical course of braking deceleration  
Rys. 1. Teoretyczny wykres opóźnienia hamowania

In figure 1 it is possible to deduct that the best braking parameters corresponds with curve 1). All vehicles (No1, No2, No3) start braking in the moment  $t_0$  (appears of braking deceleration). Vehicle No1 reaches maximum deceleration of braking in the moment  $t_1$  and in the point A started effective braking. Vehicle No2 also started braking in the moment  $t_0$  with longer time of increasing of the braking deceleration. Full effective braking process of the vehicle No2 started just only in the moment  $t_2$  (B point). Vehicle No2 obtained longer braking distance than the vehicle No1. Time of braking deceleration increasing influences on the length of the braking distance.

## 2. EXPERIMENTAL PROCEDURE

The investigation of braking deceleration was carried out. ABS in Fiat Panda 1.3 JTD was tested.

During investigation pressure in pneumatic tyres were changed. Measurement was done for two different kinds of surfaces: wet and dry asphalt pavement. The definition of influence of pressure level in tyres of vehicle with ABS on different kinds of road surface on characteristic parameters of braking are treated as a purpose of measurements. Test car was equipped by ABS with Electronic Brake-Force Distribution system (EBD), ventilated disc brakes on front axle and drum brakes on rear axle, serial tubeless tyres about 155/80R13 size. The diagram and basic technical data of the braking system are shown on the figure 2 and in the table 1.

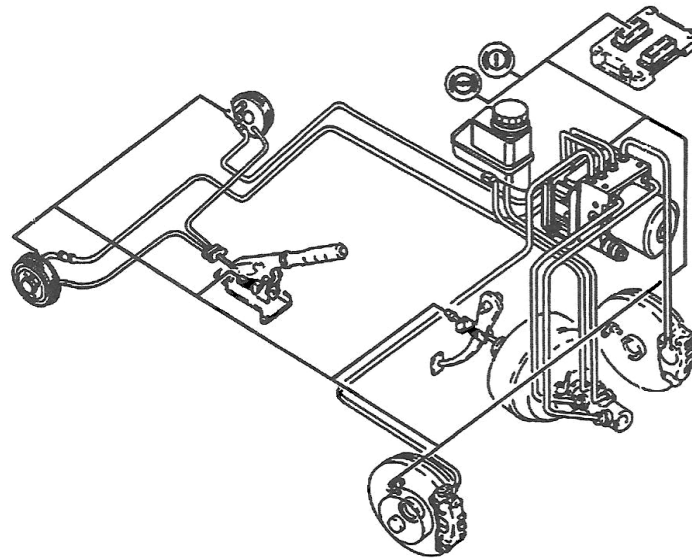

Fig. 2. Braking system diagram of Fiat Panda 1.3 JTD [4]

Rys. 2. Schemat układu hamulcowego Fiat Panda 1.3 JTD [4]

Tab. 1

Basic technical data of braking system of Fiat Panda 1.3 JTD [4]

No.	Technical data	Describe
1	Running mechanism	Hydraulic with vacuum assisting
2	Diameter of brake master cylinder	20.64 mm
3	Diameter of servo brake assembly cylinder	228.6 mm
4	Front brakes	Disc brakes
5	Kind of disc	Ventilated disc
6	Disc diameter	240 mm
7	Nominal thickness of disc	19.9 ÷ 20.1 mm
8	Thickness of disc after repair	18.55 mm
9	Min acceptable thickness of disc	18.2 mm
10	Diameter of hydraulic piston	48 mm
11	Rear brakes	Drum brakes
12	Drum diameter	180 ÷ 180.25
13	Max diameter of drum after repair	180.85 mm
14	Max acceptable diameter of drum	181.25 mm
15	Diameter of brake piston	20.6 mm
16	Extra equipment	ABS, EBD

Front axle load is bigger than front axel static load during braking. Also rear axle load is smaller than rear axle static load during braking. Changes of the pressure in pneumatic tyre were done only for tyres of the front axle. Examinations have included registration of braking deceleration with the

various pressures in tyres of the front vehicle axis on dry and wet road surface (table 1). Pressure in rear tyres was determined by the recommendation of the vehicle producer (0.2 MPa).

Tab. 2

Plan of investigations

No.	Kind of road surface	Pressure in pneumatic tyre of front axis [MPa]
1	dry	too low: 0.1
2		nominal: 0.2
3		too high: 0.3
4	wet	too low: 0.1
5		nominal: 0.2
6		too high: 0.3

During measurement the vehicle was loaded with two adult sitting on the front seats (the driver and the passenger). The test consisted of acceleration of the vehicle to the velocity about 60 km/h and next emergency braking (including work of the ABS). Every measurement was repeated twice in driving in the opposite direction [5].

Measurements were carried out with decelerometer VZM100. This device is allocated for registration and to substantiate the deceleration in real time during braking. Decelerometer works of registration of inertial force when the vehicle is in retarded motion (during braking), and then processes this size for the deceleration (taken in  $m/s^2$ ) and registers on the printout [6].

The investigations of the deceleration of vehicle were measured in the following conditions:

- the examination were carried out on a section of road which wasn't causing the threat of road safety,
- in tyres with the back axle pressure was determined on the nominal level recommended by the vehicle producer ( pressure was changed in the front wheel tyres in accordance to the plan of investigations),
- the vehicle was loaded with two persons sitting on the front seats,
- the road was flat (without inclination) with flatten and clear asphalt surface,
- the driver use only the main brake, moreover clutch was excluded in the last phase of braking.

Fig. 3 shows preparation of decelerometer VZM100 to investigation.



Fig. 3. Decelerometer VZM100 used in investigations

Rys. 3. Opóźnieniomierz VZM100 używany w badaniach

### 3. RESULTS AND DISCUSSION

Printout from decelerometer is shown in figure 4. Quantities which are described while braking process (braking distance, maximum braking deceleration, etc.) were calculated on the basis of printouts.

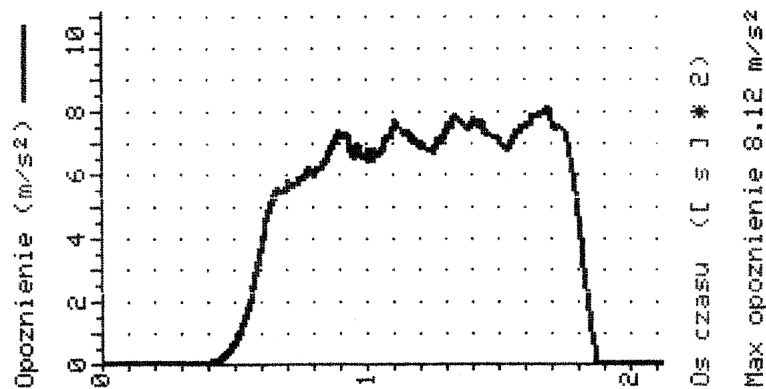

Fig. 4. Example of decelerometer printout  
Rys. 4. Przykład wydruku z opóźnieniomierza

The figure 5 shows values of maximum deceleration in depending on type of surface and pressure in tyres of the front axis.

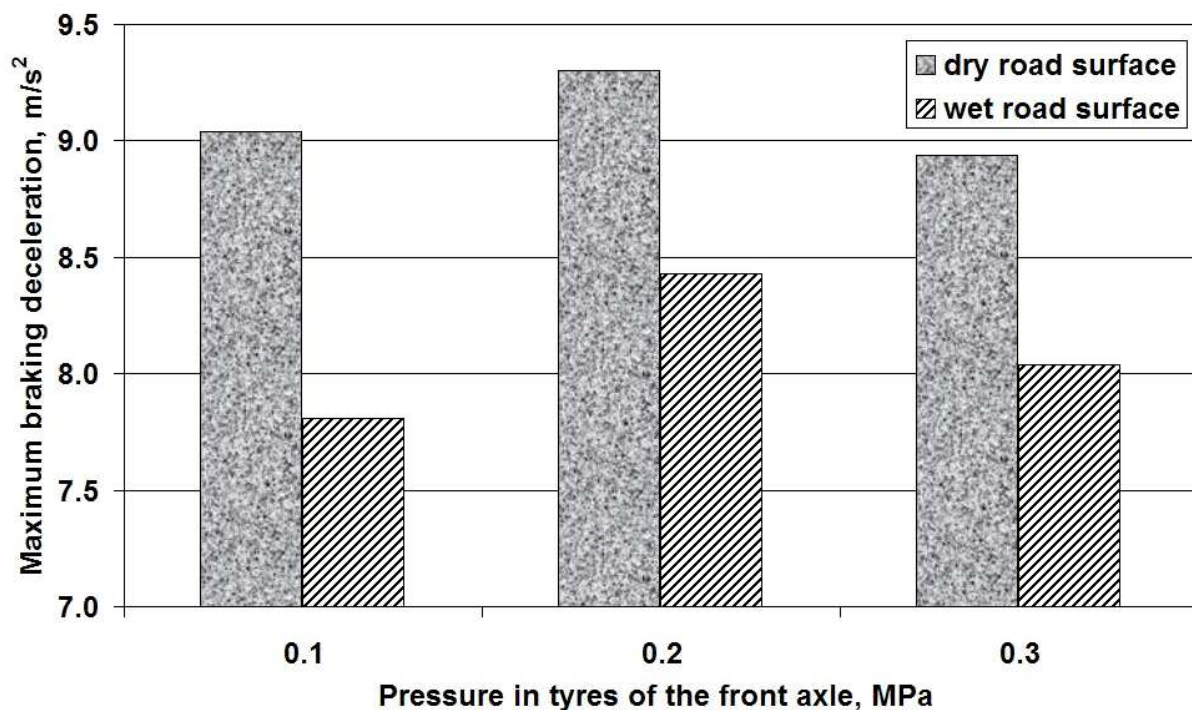

Fig. 5. Maximum deceleration in terms of type of surface and pressure in tyres of the front axle  
Rys.5. Maksymalne opóźnienie w zależności od rodzaju nawierzchni oraz ciśnienia powietrza w kołach przedniej osi

The biggest deceleration was registered for braking with the nominal level of the pressure in tyres of the vehicle, irrespectively of the kind of surface (about  $9.3 \text{ m/s}^2$  on the dry surface and about  $8.4 \text{ m/s}^2$  on wet). Braking with other pressure than nominal one did not give unambiguous results. Bigger car deceleration on wet road surface was registered with too high pressure in tyres for braking process (about  $8 \text{ m/s}^2$ ), however bigger deceleration on dry road surface was registered with too low pressure (about  $9 \text{ m/s}^2$ ).

Figure 6 shows maximum values of braking distance in terms of type of road surface and pressure in tyres of the front axis. Braking distance values (the arithmetic averages from attempts) were carried out.

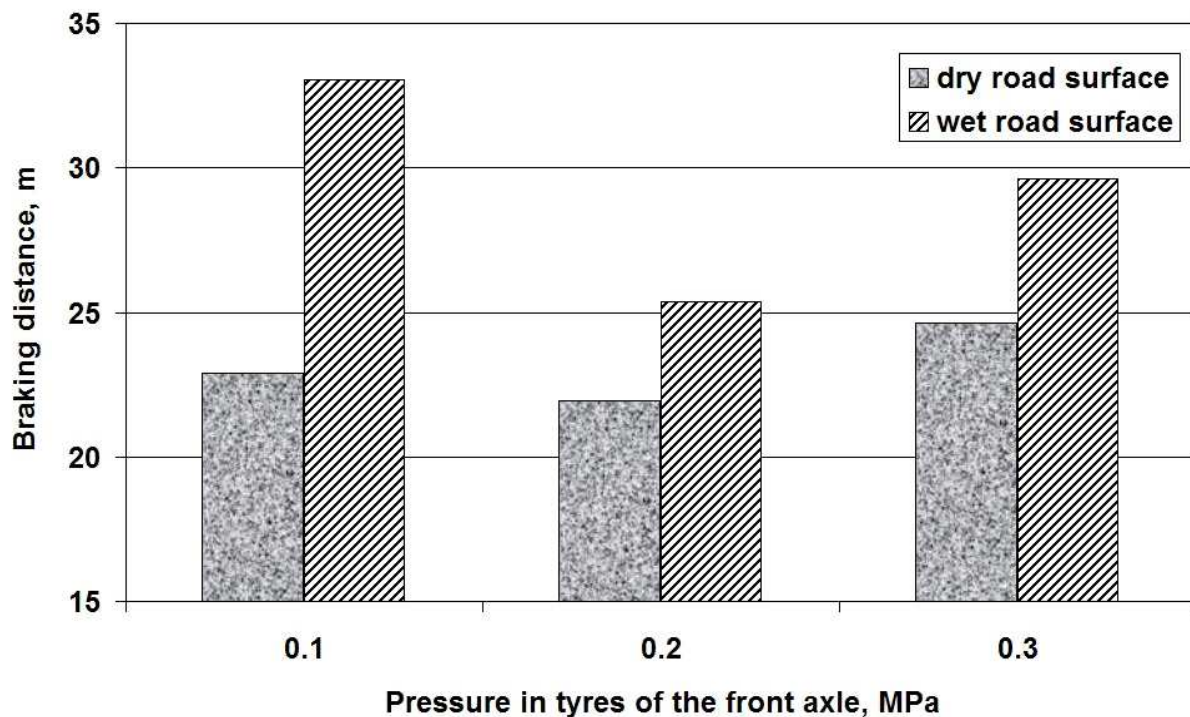

Fig. 6. Braking distance in terms of pressure of front wheels tyres and of the kind of road surface

Rys. 6. Droga hamowania w zależności od ciśnienia powietrza w kołach przedniej osi oraz rodzaju nawierzchni

The shortest braking distances were registered for attempts with the nominal level of the pressure in tyres of the vehicle, irrespectively of the kind of surface (about 22 m on the dry road surface and about 25.4 m on wet road). The longest braking distance on dry surface was registered at the attempt with too high pressure in tyres (about 24.6 m), however the longest braking distance on the wet surface was observed during the attempt with too low pressure (about 33 m).

Time of braking deceleration increasing to the maximum value was difficult to determine in this case. Real course of the braking deceleration is different from theoretical one. On theoretical course of braking deceleration fixes the maximum value of deceleration. Maximum value of deceleration is constant. However characteristic hesitation of the maximum value of the deceleration was observed during tests (because of ABS). Pressure in the brake system was changing independently of force of the pressure on the brake pedal. It was difficult to define the time of increasing of braking deceleration. Measured of time of braking deceleration increasing to moment when braking deceleration was equal  $5 \text{ m/s}^2$  was suggested.

Figure 7 shows time of increasing of braking deceleration to moment when deceleration was equal  $5 \text{ m/s}^2$  in term of the pressure in tyres of the front axis of the vehicle and of the kind of surface. Time of deceleration increasing values (the arithmetic averages from attempts) was carried out.

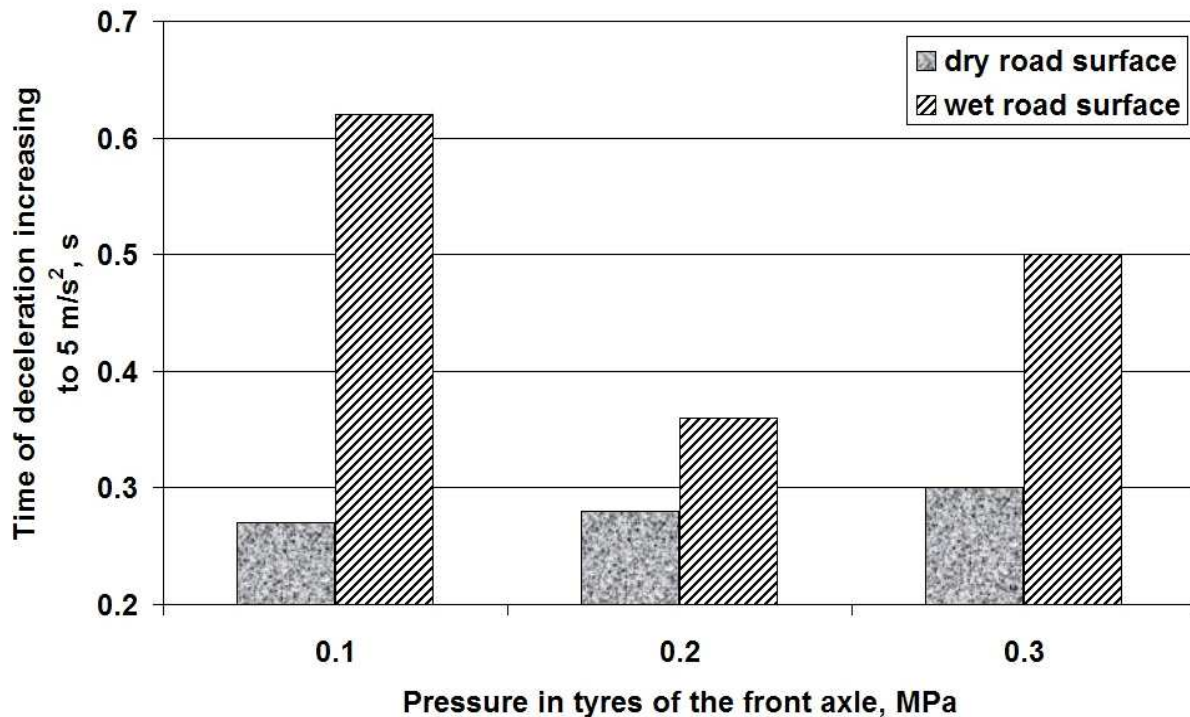

Fig. 7. The time of deceleration increasing to  $5 \text{ m/s}^2$  in terms of the pressure in tyres of front wheels of the vehicle and of the type of surface

Rys. 7. Czas narastania opóźnienia hamowania do wartości  $5 \text{ m/s}^2$  w zależności od ciśnienia powietrza w kołach przedniej osi oraz rodzaju nawierzchni

On dry road surface the shortest time of deceleration increasing was observed for the nominal pressure in tyres (about 0.36 s), however the longest time of deceleration increasing was observed with too low pressure (around 0.62 s). On wet road surface difference between values of time of deceleration increasing is very small and they are no greater than 0.3 s.

Characteristics of vehicle velocity and braking distance in terms of time of braking were made out to determine reasons of difference between levels of characteristic parameters for different conditions.

Figure 7 shows changes of the vehicle velocity and the braking distance in the braking time with the nominal level of the pressure in front wheels tyres (0.2 MPa). Bigger drops of vehicle velocity on dry road surface were registered in constant intervals of time comparatively with the similar attempt on the wet road surface (smaller slant of the curve). This phenomenon influenced length of the braking distance increment. Braking on dry surface was observed on the distance about 22 metres, however braking process on the wet road surface it was observed with a distance longer than 25 metres.

Figure 8 shows relations of changes course of the vehicle velocity and the braking distance in the braking time with too low pressure in front tyres (0.1 MPa). In this case delay in the drop of the velocity was registered at the beginning of the braking process. It was the reason of a longer braking distance. The bigger velocity changes were observed on the dry road surface. The braking process on the dry road surface was observed on the distance of 23 metres, however braking distance on the wet road surface was longer (above 33 metres).

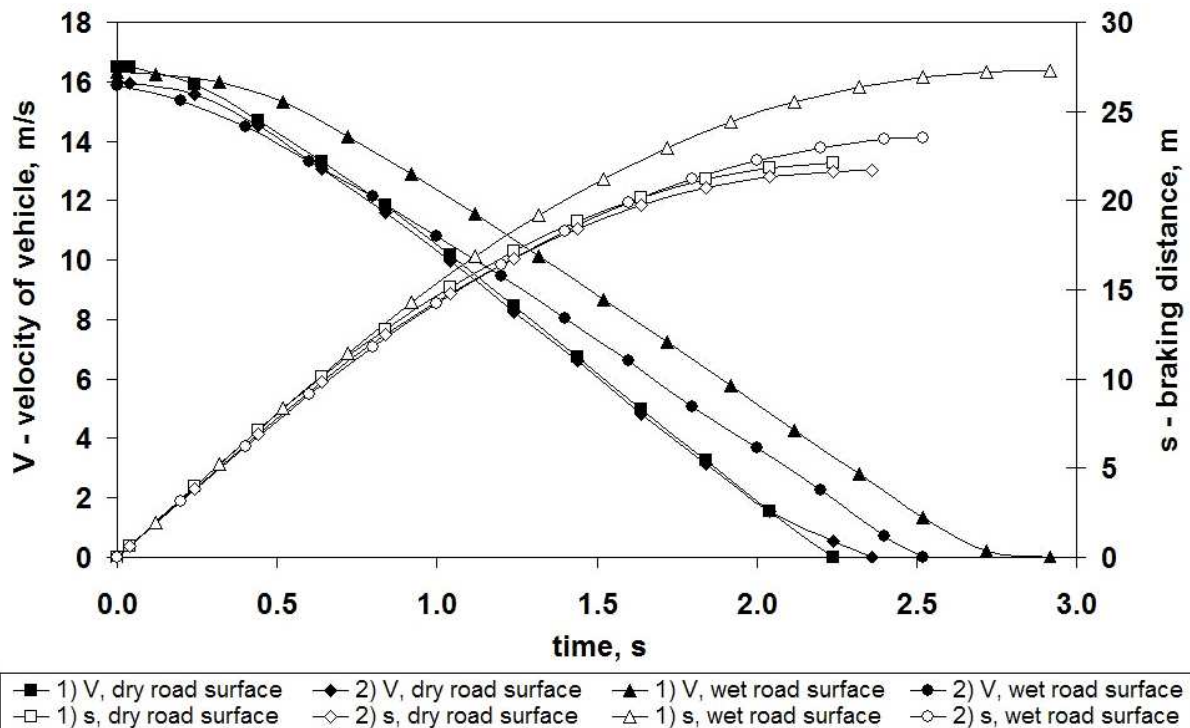

Fig. 8. The vehicle velocity and the braking distance in terms of braking time for the nominal pressure in tyres of front wheels

Rys. 8. Prędkość pojazdu i droga hamowania w zależności od ciśnienia powietrza w kołach przedniej osi oraz rodzaju nawierzchni

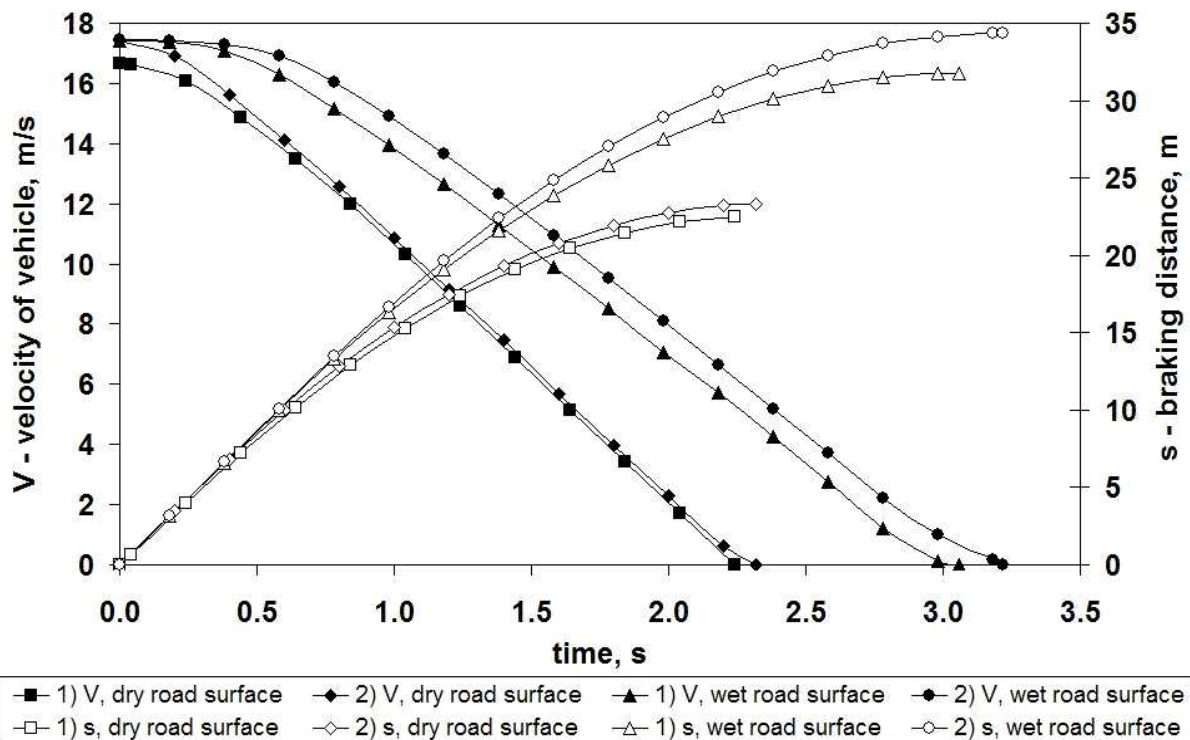

Fig. 9. The vehicle velocity and the braking distance in terms of braking time with too low pressure in tyres of front wheels

Rys. 9. Prędkość pojazdu i droga hamowania w zależności od ciśnienia powietrza w kołach przedniej osi oraz rodzaju nawierzchni



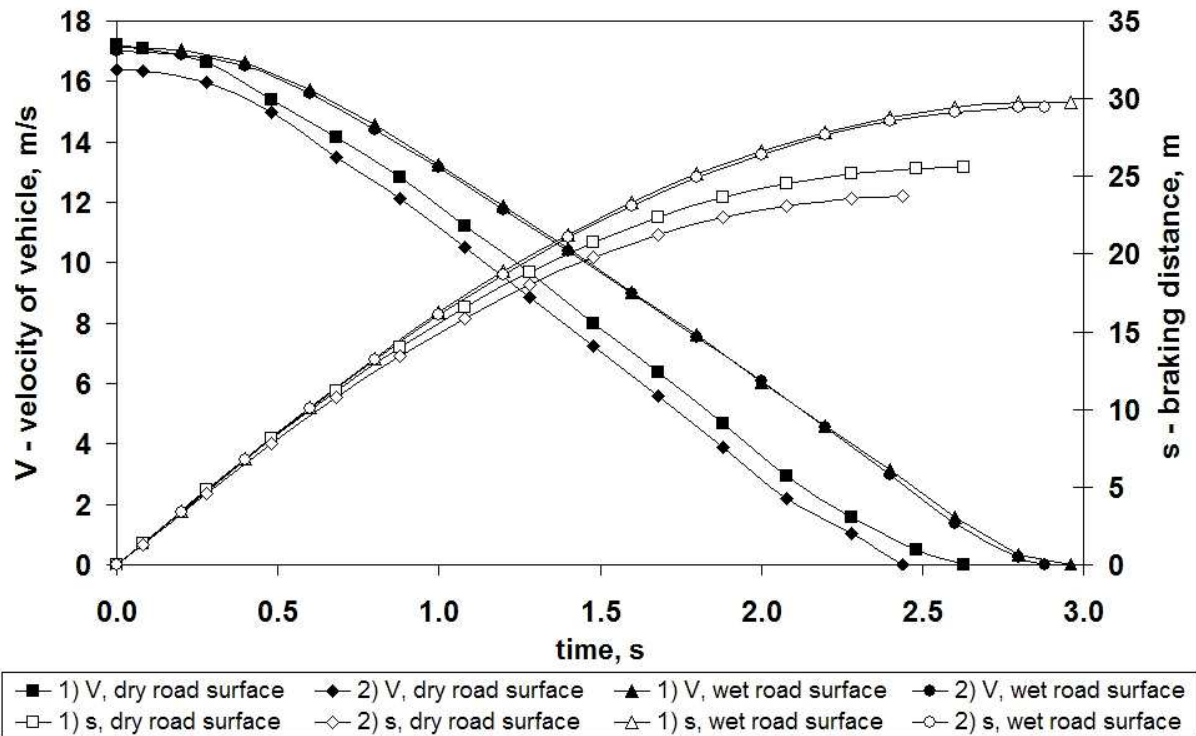

Fig. 9. The vehicle velocity and the braking distance in terms of braking time with too high pressure in tyres of front wheels

Rys. 9. Prędkość pojazdu i droga hamowania w zależności od ciśnienia powietrza w kołach przedniej osi oraz rodzaju nawierzchni

Figure 9 shows relations of the vehicle velocity and the braking distance in the time with too high pressure in tyres of front wheels (0.3 MPa). Bigger drop in the vehicle velocity was registered on dry road surface. Braking process on dry road surface was a distance similar to 24.5 metres, however on the wet surface it was observed on the longer distance (above 29.5 metres).

#### 4. CONCLUSIONS

On the basis of investigation results observed that:

- the value of the pressure in pneumatic tyre influences braking process of vehicle with ABS and driving safety,
- the biggest value of the braking deceleration was obtained for braking with nominal value pressure in tyres,
- the shortest braking distance was obtained for braking with nominal value pressure in tyres,
- the value of pressure in tyres determines time of increasing deceleration,
- optimal course of the braking process was obtained with nominal value pressure in tyres,
- antilock brakes keep wheels from locking up, so the car maintains directional control around hazards if the driver can't make a complete stop in time.

**Bibliography**

1. [www.samarins.com/glossary/abs.html](http://www.samarins.com/glossary/abs.html), 17 March 2008
2. [www.nhtsa.gov/cars/problems/Equipment/absbrakes/page1.html](http://www.nhtsa.gov/cars/problems/Equipment/absbrakes/page1.html), 17 March 2008
3. *Elektrotechnika i elektronika samochodowa. Układy bezpieczeństwa i komfortu jazdy. Informator techniczny Bosch*. WKiŁ, Warszawa 2000.
4. Zembowicz J.: *Fiat Panda*. WKiŁ, Warszawa 2006.
5. Sitek K.: *Diagnostyka samochodowa*. Wydawnictwo AUTO, Warszawa, 1999.
6. Instrukcja obsługi opóźniomierza VZM100, MAHA.

Received 27.03.2008; accepted in revised form 26.04.2008