

diagnostics of cranes, inclusions, permanent deflections cracks

Artur BLUM*, **Kamil HAREMSKI**
AGH University of Science and Technology
Al. Mickiewicza 30, 30-059 Kraków, Poland
**Corresponding author. E-mail: art_blum@agh.edu.pl*

EMERGENCY DIAGNOSTICS OF LOAD-CARRYING STRUCTURES INTO THE WORKS TRANSPORT

Summary. Sudden increase of exploited cranes since 1970 year and implementation of European standards restricting safety factors were cause of many breakdowns and accidents. That's why act about technical supervision from 2000 year impose checkups of technical conditions of supporting structures every 12 months. Checkups include also welded joint and crane tracks. Aim of routine test is to find out if there are no damages which may affect on constructions safe exploitation. Routine tests give information if construction can be exploited. Article presents methodology of diagnostics inspection for defect detection of constructions and its practical application.

DIAGNOSTYKA USTROJÓW NOŚNYCH URZĄDZEŃ TRANSPORTU BLISKIEGO

Streszczenie. Datujący się od początku lat siedemdziesiątych gwałtowny wzrost ilości eksploatowanych dźwignic oraz wprowadzone liberalne normatywy europejskie zawężające margines wytrzymałości konstrukcji prowadziło i prowadzi do wielu awarii i wypadków. Dlatego ustawa o dozorcze technicznym z 2000 r. narzuciła co 12 miesięcy sprawdzanie stanu technicznego konstrukcji nośnych, a w szczególności połączeń spawanych i torów jezdnych. Celem badań okresowych jest stwierdzenie czy nie powstały uszkodzenia mające wpływ na bezpieczeństwo eksploatacji konstrukcji. Na tej podstawie formułowane są działania naprawcze. W artykule przedstawiono metodykę badań diagnostycznych wykrywania uszkodzeń konstrukcji wraz z jej technicznym zastosowaniem.

1. INTRODUCTION

Large amount of short transport devices used in industry facilities were produced in 60-90 years last century. Cranes produced in last years need periodic inspections of their technical condition to ensure work safety.

It is free to use standards concerning manufacturing end exploitation of short transport devices after joining European Union by Poland. It is concluded in law from day 12 of September 2002 (Dz. U. Nr 169, poz. 1386) and standard PN-ISO 7363:1996 depends requirement of initial bend of crane girders on contractor demands. Initial bend demanded on crane producers till 90 years was initiating compressive stress to stretched zone from own and exploitation loads and stretching stress to compressive zone. Cause of this equivalent stress were redistributed, which values were increasing fatigue strength of bridges. Lack of initial bend is seen after few years of crane exploitation in form of

increase of permanent deflection of crane bridge. That's why technical diagnostics of cranes is really important.

To ensure safety requirements of exploited steel constructions it's necessary to make periodic controls of technical condition of those devices. Technical condition of steel constructions is determined by structure condition, state of its degradation after long years exploitation, amount and type of interior defects [1]. Nondestructive investigation methods of material condition especially ultrasonic methods are really important in industry [2,3].

Cracks seen in steel are double kind. Very small cracks on nonmetallic inclusion borders with metal inside inclusions appear after cold deformations and cyclic influence of stress – fatigue of material. Large macro cracks arises near welds directly after welding or later as hover cracks. Initiators are often laminated nonmetallic inclusions. Such cracks have tendency for progressive growth during construction exploitation. They create lamellar cracks.

Observation of reflected signal from defect on flaw detector screen can give quantitative information about its depth and size. It is made by using OWR plot to determinate diameter of "substitute defect". Substitute defect and its diameter gives information about defect shape, thickness and type (crack, inclusion). It only gives information about defect size in perpendicular plane to fading flat wave (its active section on backward scattering). Real material morphology of interior defects is complex. Area with different interior defect density, size and scattering are observed [1]. Not straight signal (echo) reflected from defect (reflector) gives information about defect location, thickness and its type. Those information can be acquired from simple comparing of defect echo shape with bottom echo or echo reflected from delaying line border (introducing impulse). Condition of construction surface (paint covering, oxidized surface, surface roughness) has colossal influence for comparative analysis.

Insertion to exploitation ultrasonic flaw detectors working on high frequencies with converters eliminating wide frequency band with digital recording not straight signal enabled mathematical signal processing – usage of Fast Fourier Transform (FFT) – to obtain amplitude-frequency characteristic (AC). Converting signals to digital form enables new opportunities for their further digital conversion and analysis with usage available mathematical packages. Changes of AC characteristics during material penetration or its reflection from interior defects carry inside information about its type and defect type [3]. It gives opportunities to estimate them without necessity of usage destructive metallographic researches. It is really important in exploitation diagnostics of steel constructions.

Diagnostic investigation of deflected constructions were including flaw detector investigation, ultrasonic and magnetic of middle plates, bottom belts and weld connections with identification of nonmetallic inclusions and lamellar cracks.

Initial localization of discontinuity were investigated by ultrasonic research with flaw detector USM-35S with dual converter head MSEB-4-4. Further in those regions principle not destructive research were made with usage of flaw detector USLT-20001\I with miniature sending-receiving head G15MN.

Paste Krautkramer was used as coupling factor. Scaling operation was made on UW-1 sample.

Technical data of ultrasonic flaw detector USLT-2000I:

- working frequency 0,5 – 20 MHz,
- range of observation for steel min. (0 – 2,5 mm), max. (0 – 1000 mm),
- repetition frequency 8 – 1000 Hz,
- amplification 0 – 11dB,
- sampling frequency (10 bites), max. 240MHz
- processor 226 MHz, Pentium II, 52 MB RAM, 4 GB hard drivem
- operating system Windows 98

Magnetic research were made according to PN-EN JSO 9943-1 requirements with flaw detector Uniflucut 230V. Parameters of research were chosen with help of Bermold's sample and magnetic field intensity meter MFM 200.6. Before investigation surface was mechanically processed by hand polishing.

Black magnetic powder in aerosol M76 was used. White magnetic undercoat was used as contrast factor. Observation was made in white light 100 W.

Figure 1 presents pictures of diagnostic investigation of crane bridge which scheme is on fig. 2. Research results of s5 zone (according to fig. 2) with mathematical description of signal with usage of FFT were shown on fig. 3.

Next figure (fig. 4) presents results of permanent deflected bridge crane girders geodesic investigation and picture of crane.



Fig. 1. Investigation with flaw detector USM-35M (left) and flaw detector USLT 2000I (right)
Rys. 1. Badanie defektoskopem USM-35M (po lewej) oraz defektoskopem USLT 2000I (po prawej)

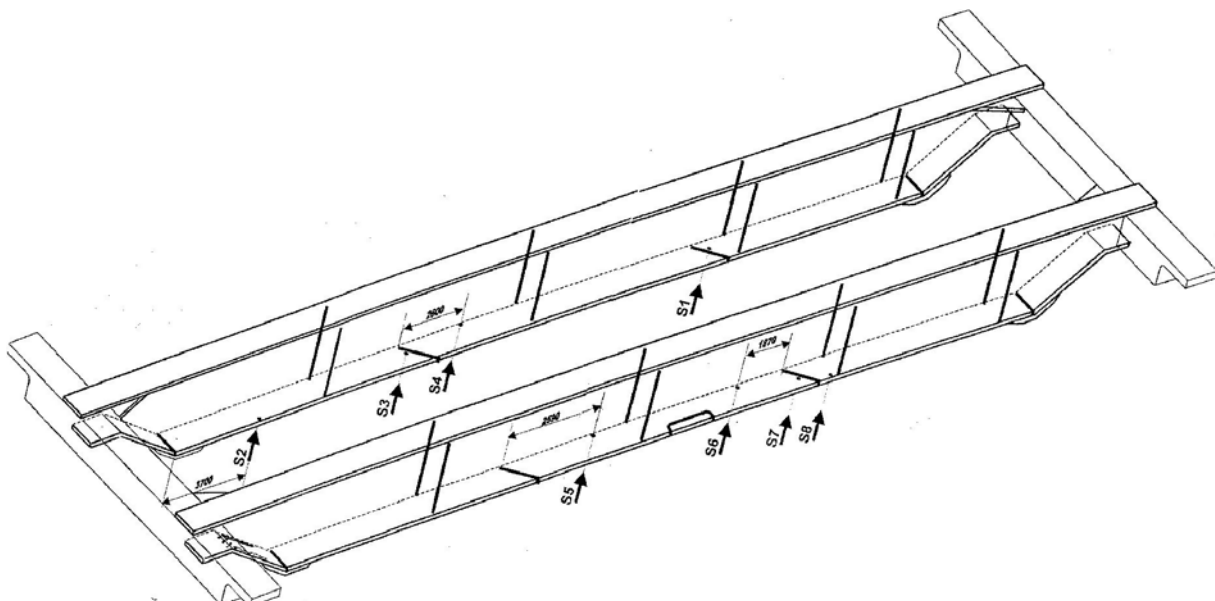

Fig. 2. Scheme of investigated crane bridge with flaw detector investigation zones
Rys. 2. Schemat badanego mostu suwnicowego z umiejscowieniem stref badan defektoskopowych

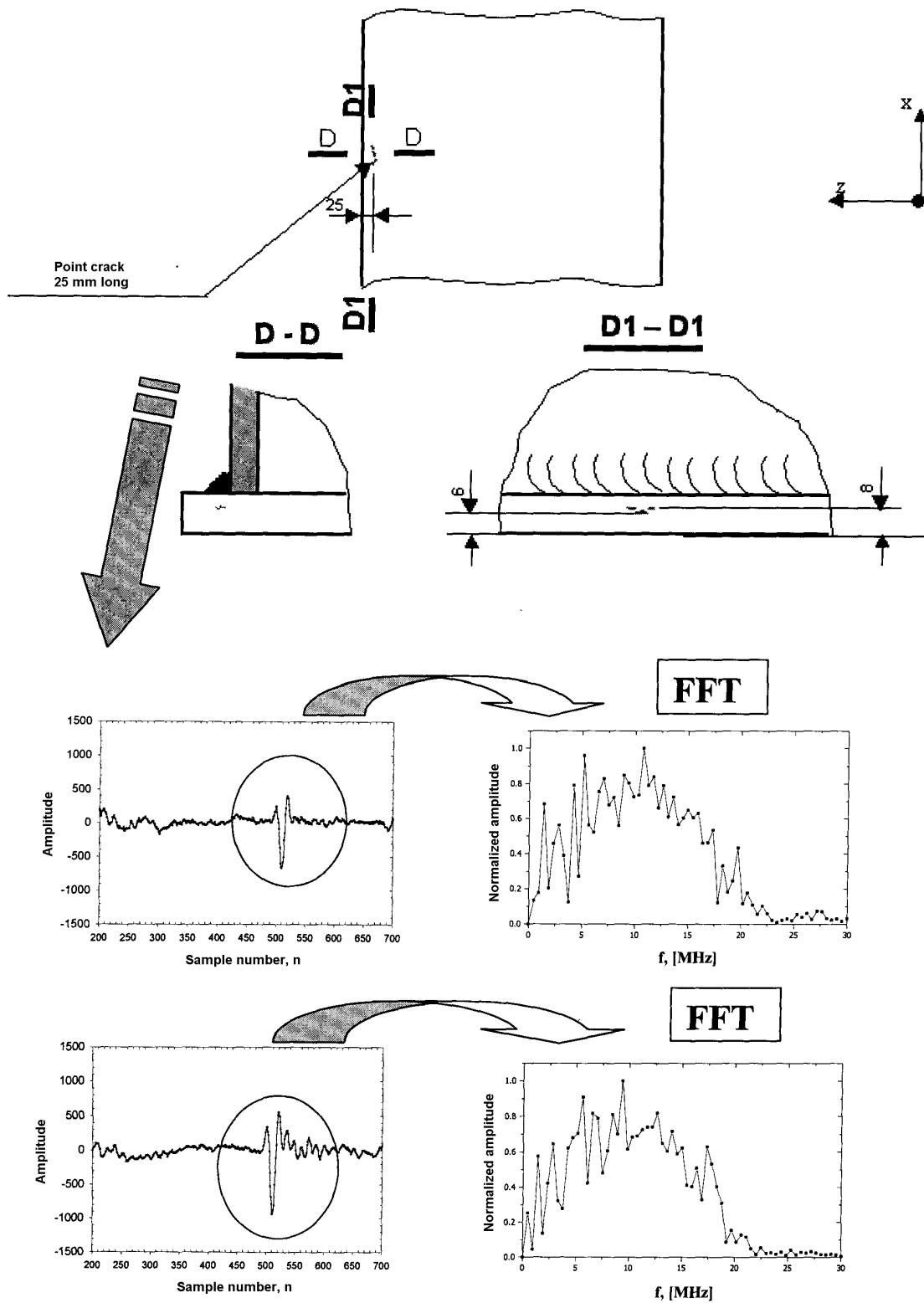

Fig. 3. Identification of crack in s5 zone (fig. 2)
 Rys. 3. Identyfikacja pęknięcia w strefie S5 (rys. 2)

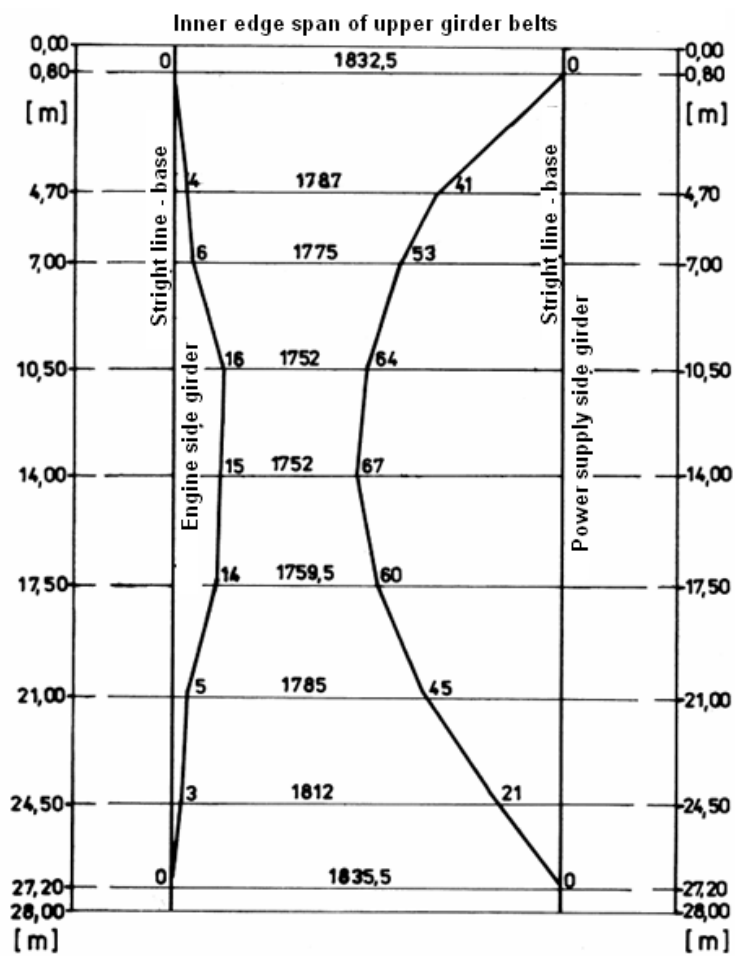
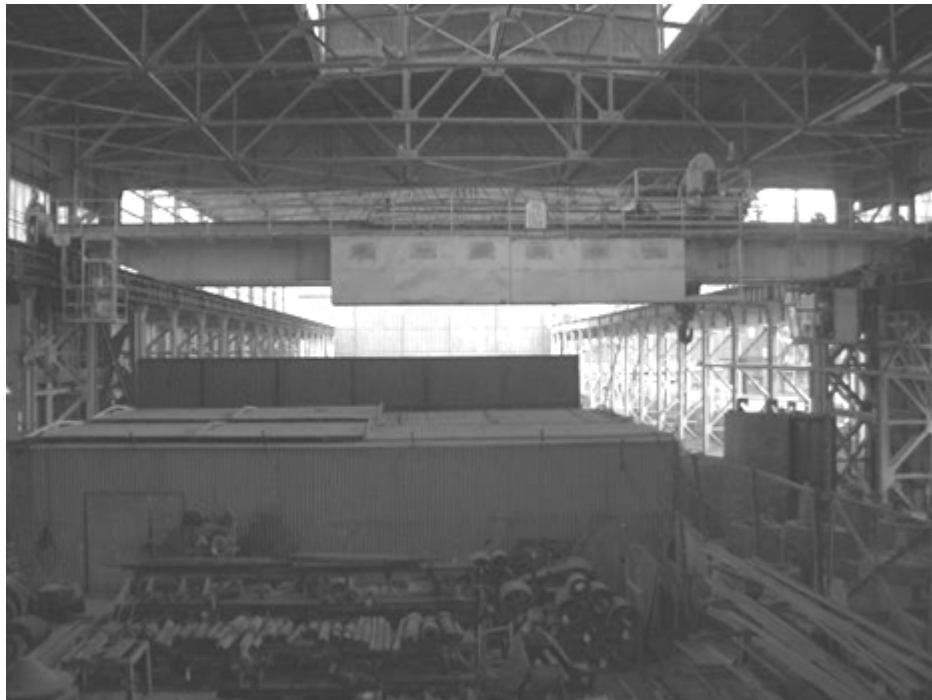

Fig. 4. Picture of crane and geodesic investigation results

Rys. 4. Zdjęcie suwnicy wraz z operatem geodezyjnym rezultatów trwałych ugięć dźwigarów mostowych

2. SUMMARY

Result of last several years investigations shows that in stretched zones of long time exploited steel bridge cranes local stress concentration around nonmetallic inclusions can be observed. Around nonmetallic inclusion yield limit is exceeded. Density is increased and with obsolescence it causes decrease of yield limit of those zones. Further consequence is proven before formation of micro and macro cracks [6]. Material investigation taken from scraped crane shows that elongation in neutral zone has decreased by 11% and in tensile zone it has increased by 46%. Yield limit has increased by 25% for neutral zone and 35% for tensile zone. Tensile strength was increased by 8% for neutral zone and 18% for tensile zone.

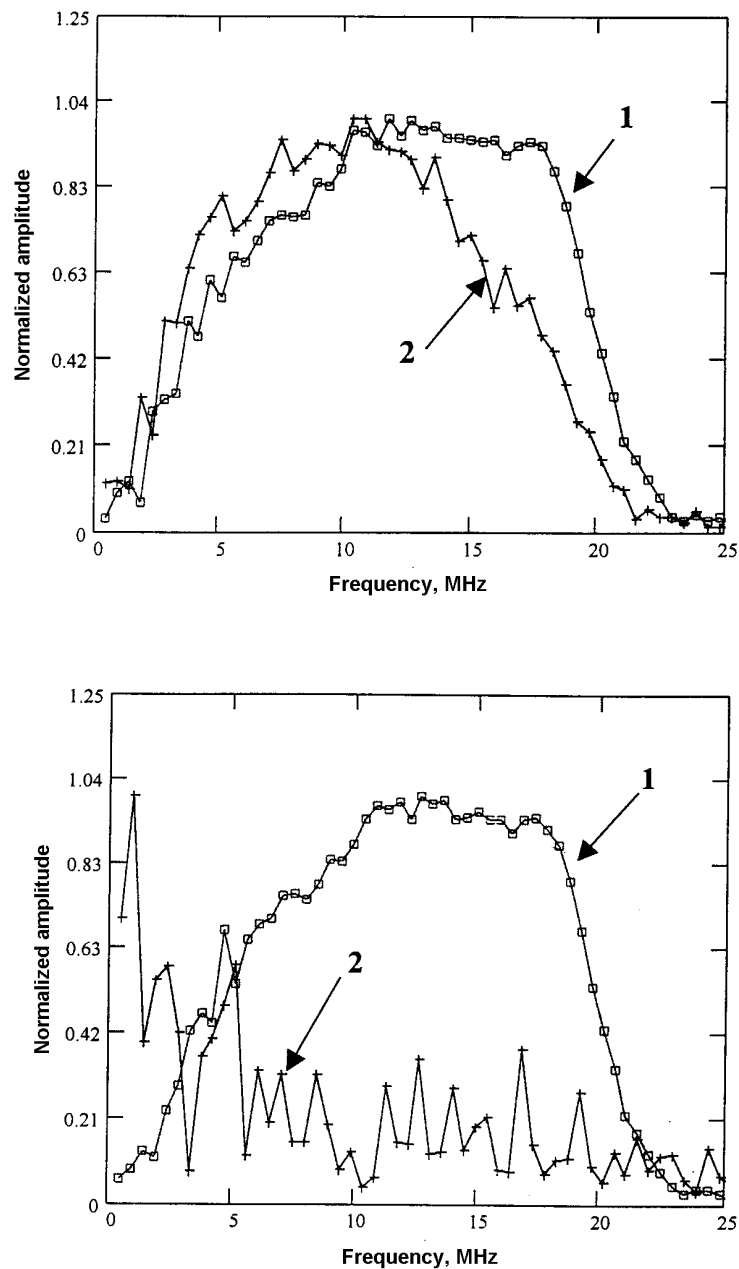

Fig. 5. Characteristic of reflected signal for clean-iron-curve 1 and including small inclusions curve 2

Rys. 5. Charakterystyczne sygnały odbicia od czystego ferrytu krzywa 1 i wtrącenia niemetalicznego – krzywa 2

Metallographic research of samples with nonmetallic inclusions plastically deformed and low cycle fatigue loaded have shown appearance of cracks parallel to deformation direction of nonmetallic inclusions (SiO_2 , MnS , Al_2O_3) and steel division border. In consequence it leads to plate stratifying (fig. 4).

That process causes decrease of construction stiffness which reveals increase of bridge girders permanent deformations.

Point of reference for reflected from defect signal analysis is amplitude-frequency characteristics (AC) of signals which penetrates through steel plate in zone not containing defects and not reflected from flat bottom.

Initiated signal into material becomes distracted dependent of retention of interior defects (nonmetallic inclusions and cracks). Every plate filtrates initiated to it ultrasonic impulse dependent of its microstructure. It's really important for AC characteristic analysis of reflected signal from defect laying inside inspected steel.

Fig. 5 presents characteristics for clean iron ($d=8$ mm polished surface - curve 1) and including small nonmetallic inclusions ($d=10$ mm coarse surface - curve 2). During analysis of AC characteristic noise of measurement equipment has been seen. Fig. 6 shows measurement characteristic (with 72,5 dB amplification) on clean iron (curve 1) and for steel (curve 2).

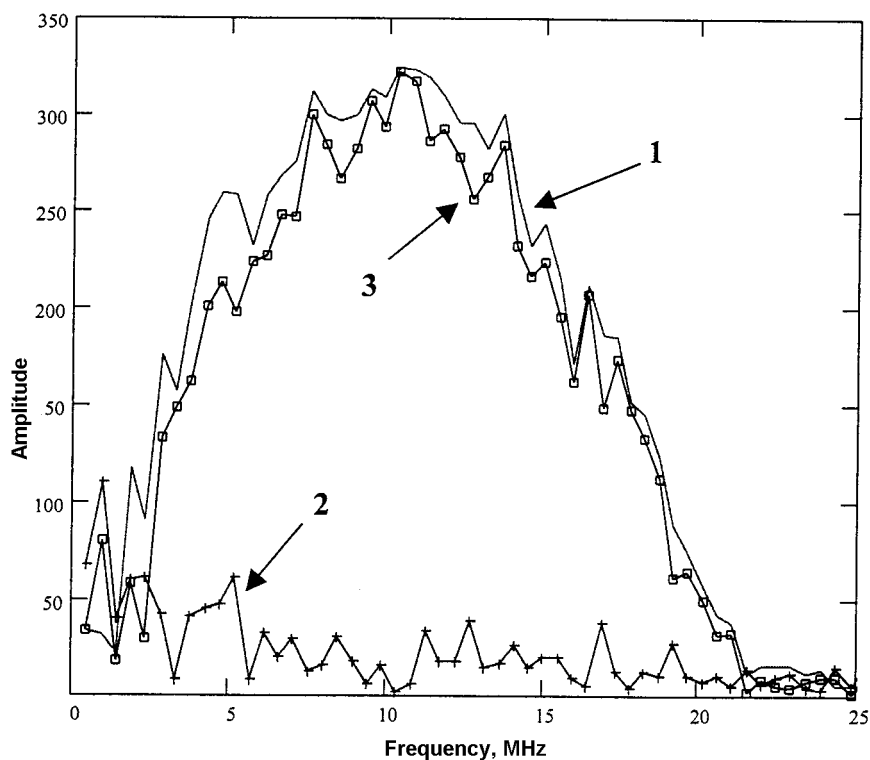

Fig. 6. AC characteristics for clean iron – curve 1 and steel – curve for amplification of 72,5 db

Rys. 6. Charakterystyczne sygnały odbicia dla czystego ferrytu – krzywa 1 oraz dla stali – krzywa 2 – wzmacnienie 72,5 db

Maximum noise is for frequency 2-2,5 MHz (beyond measurement range 13-22 MHz).

There are three types of defects in steels:

- integral and dispersed cracks
- nonmetallic inclusions laminated arranged
- nonmetallic inclusions connected with cracks

Application of FFT allows to distinguish signal reflected from cracks and reflected from laminated arranged nonmetallic inclusions.

Fig. 7 shows signal reflected from crack and fig. 8 from inclusion.

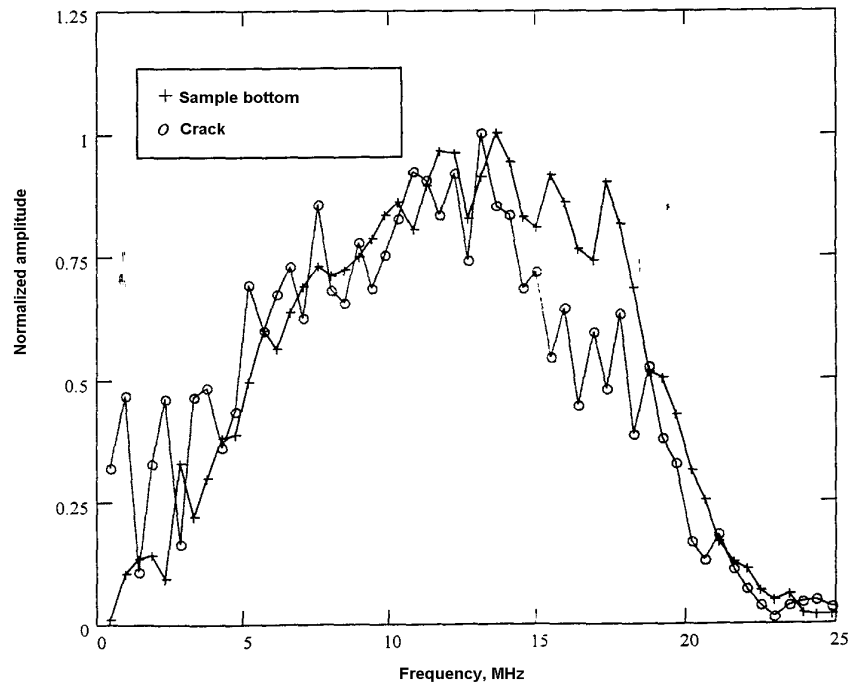

Fig. 7. Signal reflected from crack
Rys. 7. Sygnał odbity od pęknięcia

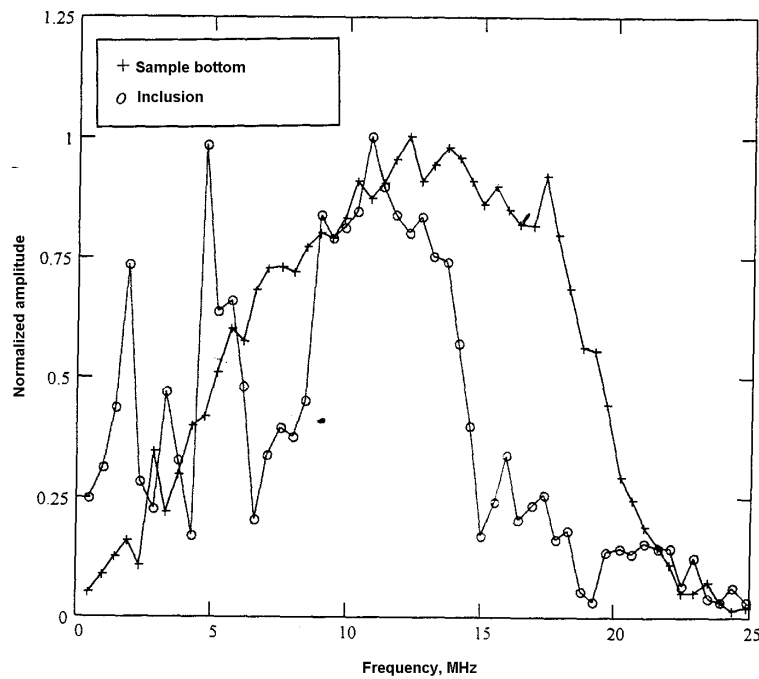

Fig. 8. Signal reflected from inclusion
Rys. 8. Sygnał odbity od wtrącenia

Introduced methodology of research isn't common in diagnostics of long year exploited steel constructions technical condition.

Initiating this method as obligatory for crane users could be source of exploited cranes technical investigation. Results of that research would show real technical condition of machines what will have important influence for their work safety.

References

1. Kruk A., Pietrzyk J., Blum A.: *Zastosowanie nowoczesnych defektoskopów ultradźwiękowych do oceny wad wewnętrznych występujących w blachach stalowych na konstrukcje dźwigarów mostów suwnicowych*. Mat. Konf. Wybrane problemy rozwoju maszyn roboczych hutniczych i ceramicznych, Problemy Inżynierii Mechanicznej i Robotyki nr 6, Wyd. Wydział Inżynierii Mechanicznej i Robotyki AGH, Kraków 2002, str. 181-188.
2. Kazys R, Svilainis L: *Ultrasonic detection and characterization of delaminations in thin composite plater using signal processing technique*, Ultrasonic 35, 1997, str. 367-383.
3. Kruk A., Pietrzyk J.: *Zastosowanie cyfrowej analizy sygnału ultradźwiękowego do oceny wad wewnętrznych w blachach stalowych.*, Inżynieria Materiałowa nr 1, 2003, str. 25-31.
4. Pilarczyk J.: *Mechanizm inicjowania i rozprzestrzeniania pęknięć lamelarnych*. Zeszyty Naukowe Politechniki Gliwickiej nr 511, Gliwice, 1977.
5. Blum A.: *Diagnostyka i regeneracja wytrzymałościowa skrynkowych mostów suwnicowych*. Wydawnictwo Instytutu Technologii Eksploatacji, Radom, 2002.
6. Blum A, Niezgodziński T.: *Pęknięcia lamelarne*. Wydawnictwo Instytutu Technologii Eksploatacji, Radom, 2006.

Received 2.04.2009; accepted in revised form 23.06.2010