

The Analysis of the Influence of the Polystyrene Patterns Shaping Parameters on the Resistance Properties

T. Pacyniak^{a,*}, K. Buczkowska^a, W. Bogus^b

^aDepartment of Materials Engineering and Production Systems, Technical University of Łódź
1/15 Stefanowskiego Street, 90-924 Łódź, Poland

^bSchaumaPlast Ogranika Sp. z o.o., Dąbrowskiego 180/194, 93-231 Łódź, Poland

*Corresponding author. E-mail address: tadeusz.pacyniak@p.lodz.pl

Received 25-05-2012; accepted in revised form 31-05-2012

Abstract

This work presents the technology of making foam plastics patterns used in casting as well as the final shaping stand. The analysis of the sintering process was carried out aiming at determining the influence of the pressure and the time of sintering on the flexural strength properties. The analysis of the research results confirmed that when the sintering pressure grows to the value of $P_a = 1,7$ bar the flexural strength also increases, when the pressure value is higher than that, the degradation of the material takes place and the strength properties decrease.

Keywords: Foundry, Lost Foam, Polystyrene Patterns, Casts

1. Introduction

The technology of the lost-foam patterns has been known since the 50ies of the 20th century due to Shroyer's patent [1], however, it was not earlier than in the 80ies of the 20th century when the casting technology using the foam patterns started to develop fast. At first, the patterns cut from polystyrene blocks and glued were substituted with the patterns made in aluminum forms which precisely reflected the shape of the cast.

Thanks to this, it was possible to start mass production of casts of high precision and repeatability instead of inefficient unit production [2].

The use of the Lost Foam technology in relation to the traditional casting technologies apart from lower production and investment costs has many other benefits:

- possibility to obtain holes in the casts without the necessity of using the cores,

- lack of the divided surface and inclination, it naturally increases the dimension precision of the cast and decreases the number of operations required for cleaning of the casts,
- use of clean sand instead of molding sand eliminates the influence of the humidity on the defects of the casts, moreover, its regeneration is cheaper,
- decrease in the number of technological devices and equipment (no forms, no mixers to prepare the masses),
- decrease in the labour inputs of the final operations as a result of the absence of joint fins, sintering and so on [3].

2. Technological basics of polystyrene pattern making

In order to obtain casts of high precision and smoothness of the surface it is necessary to pay attention to the following: good quality of the surface, low price and high strength of the patterns. The following materials are used to produce patterns: expanded polystyrene EPS known as polystyrene, polymethyl methacrylate (PMMA), polyethylene (PE), polypropylene (PP) and polycarbonate (PC).

The materials for lost foam patterns used in the process of full form cast making should guarantee:

- relevant density of the pattern,
- good quality of the pattern surface,
- dimension stability of the pattern,
- relatively fast gasification,
- being environmentally friendly,
- after gasification they should not leave any hard parts,
- low price [3].

The Lost Foam technology consists of two basic stages of the pattern making with the above mentioned parameters. The first stage is the so called process of preliminary foaming in which the granules of the extended polystyrene are subjected to initial thermal treatment, drying and activation. Then, the granules are shot with the help of a pneumatic pistol to metal matrixes which reflect the shape of the patterns, later they are subjected to another thermal treatment – the so called sintering or re-foaming. The ready pattern is taken from the matrix after being cooled first. Aiming at the lowest possible bulk density of the foamed granules it should be remembered that when the density decreases the strength and hardness of the polystyrene also decrease, thus the surface quality deteriorates.

2.1. Pre-foaming

The pre-foaming is carried out in order to obtain the required density of the foamed polymer. There are several ways of pre-foaming of the polystyrene granules:

- heating in boiling water,
- steam heating,
- high frequency current heating,
- infrared heating [4].

The pre-foaming is often performed using steam heating or its mixture with vacuum [3].

It is aimed to obtain the foamed granules of the lowest bulk density possible. It should be remembered that when the density decreases the strength and hardness of the polystyrene also decrease and the surface quality becomes worse. The foaming polystyrene is saturated with a sponging agent (isopentane) whose steaming temperature should be $28\div 30^{\circ}\text{C}$. In the process of the polystyrene expansion in the temperature of the sponging agent steaming the increase in the pressure inside the granule occurs which results in the creating the polystyrene melting temperature, that is at about 80°C , the granule sides stretch leading to expansion of its volume. At the temperature proper to the initial foaming of the polystyrene ($100\div 105^{\circ}\text{C}$), a dramatic, even by multiples, increase in the granules volume occurs. When the foaming ends, the granules are dried and cooled and then are subjected to conditioning – activation. During the conditioning, the diffusion of the atmosphere air inside the granules through its thin walls takes place. This process happens because inside the granules the pressure is lower than the atmospheric pressure as a result of the sponging agent condensation. When time passes, the steaming sponging agent diffuses outside of the granule and as a result its mass decreases. These phenomena have an important influence of the activity of the granules during the process of pattern shaping in the matrix. [3, 4, 5].

2.2. Final shaping

Depending on the purpose and requirements of the casts made of the patterns they can be cut individually from the polystyrene blocks or made in metal matrixes [6].

The most popular method of shaping of the patterns from foamed plastics is production of the patterns in specially designer matrixes mostly made of aluminum or its alloys [3, 6, 7].

This method is based on placing the foamed granules inside the matrix and re-heating them using steam. In the process of re-heating the sponging agent steaming inside the granules takes place and it causes an increase in their volume and the pressure. The pressure of the granules on the matrix walls increases dramatically, which causes their connection, and at a higher temperature ($100\div 110^{\circ}\text{C}$) their sintering takes place [3, 8]. The process of sintering can be performed when heating the granules from the walls (in the present article this method will be called the autoclave method), or passing the steam directly through the pattern (the method of steam passing). The diagram showing how the polystyrene patterns are made is presented in Figure 1. After the sintering process, the matrix together with the inside pattern is cooled, the consequence of which is the vitrification of the plastic (polystyrene) and condensation of the sponging agent. After the cooling operation the pattern is taken out of the matrix.

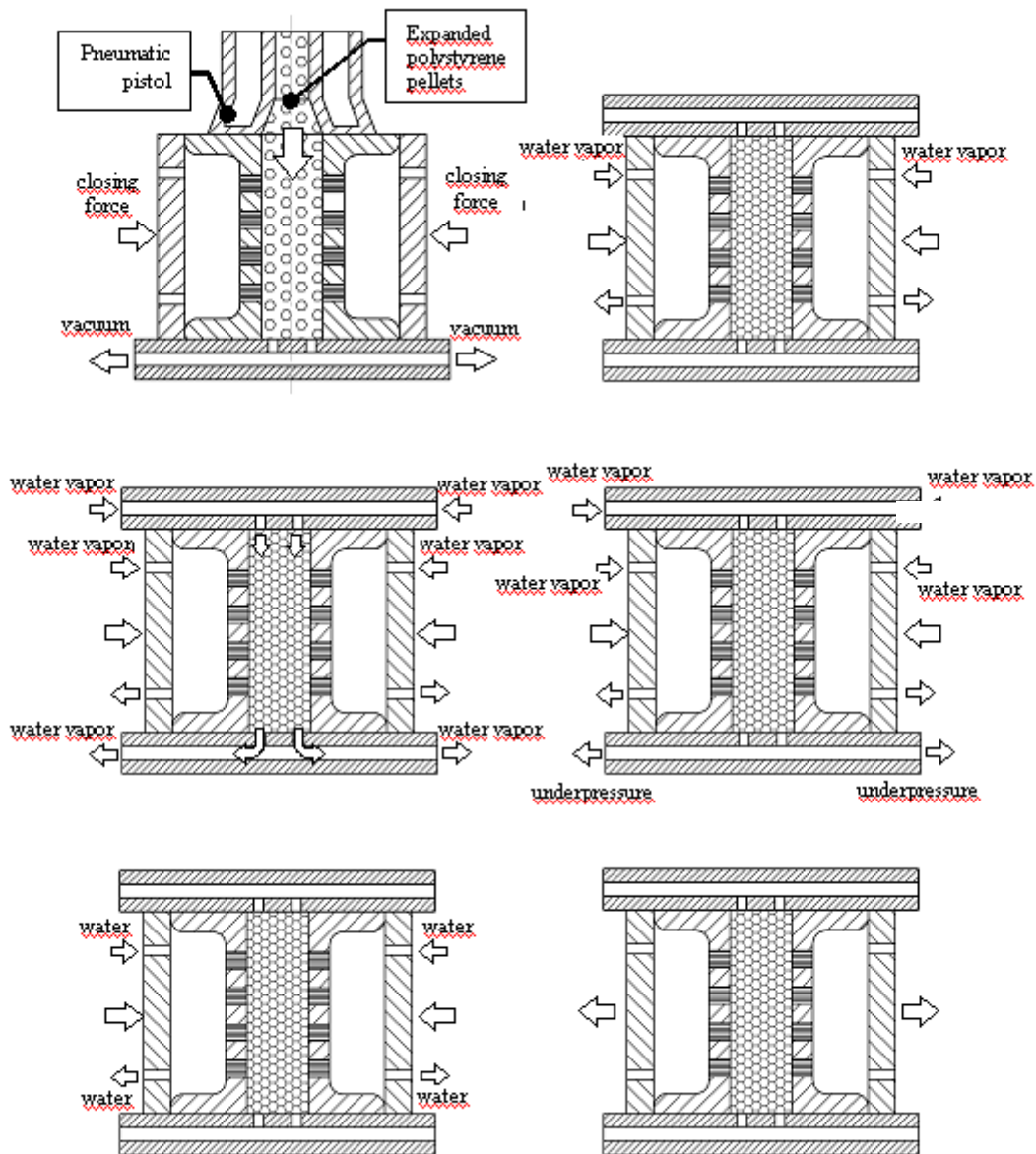

Fig. 1. The diagram of polystyrene patterns making

When the sintering process finishes, the patterns are left in the air to obtain a higher springiness of the granules which causes a slight increase in the pattern's strength. It happens due to a gaseous interchange between the granules and the environment.

The air diffuses inside the granule and simultaneously the sponging agent diffuses outside.

During the final shaping process the most important parameters are the time and the temperature. In practice, it is easier to control the steam pressure than the temperature.

The density of the patterns should be controlled because it influences the following properties:

- mechanical stability,

- surface smoothness,
- quantity of the produced gas,
- shrinkage and pattern dimensions [3, 7, 9].

A lot of factors influence the quality of the casts made according to this technology, such as: density of the pattern from the foamed polystyrene from which the strength of the pattern and the surface quality depend; the kind of the sand and especially its carrying capacity and fire-resistant coating applied on the pattern which is the working surface of the form allowing to obtain the relevant quality of the cast surface and prevents penetration of the metal to the sand [5, 10, 11]. The density of the pattern mainly

depends on the bulk density of the initially foamed polystyrene; the density of the pattern itself is about 20% higher than the bulk density of the initially foamed polystyrene. It is connected with better condensation of the granules in the form.

3. Polystyrene patterns shaping stand

3.1. The description of the stand

The E.A. HEITZ 67269 automatic device was used in the process of shaping which construction is presented in Figures 2 and 3. The device is installed at the production stand of the SchaumaPlast Organika company.



Fig. 2. E.A. HEITZ 67269 automatic device

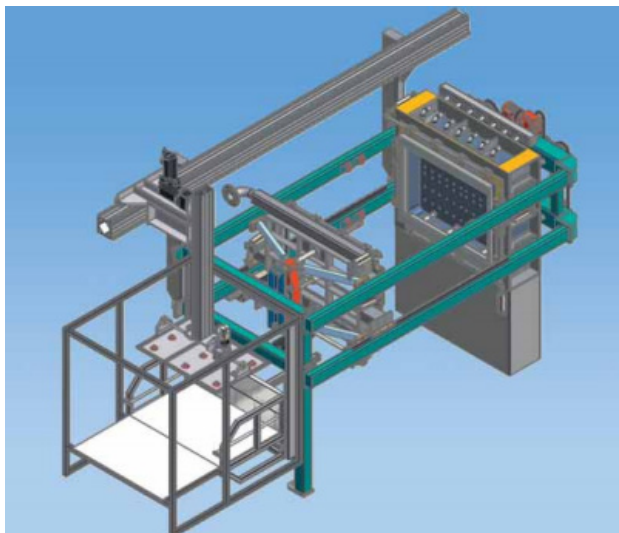

Fig. 3. The structure diagram of the E.A. HEITZ automatic device [12]

The device consists of a stable part to which a pneumatic pistol is attached which is used for feeding the pre-foamed polystyrene granules, the supply systems of steam and

compressed air and a part of the form with the system of ejectors, counter ejectors and evaporators is fixed. In the moving part of the table the other part of the form is fixed where the media are also connected (water steam and compressed air). The moving part moves on the providers with the help of pneumatic servomotors. The device is started from a control cabinet with a touch screen enabling to choose the right sintering parameters. It is possible to use the autoclave alone or with the function when steam passes directly through the pattern. The diagram of the device with passing steam is presented in Figure 1.



Fig. 4. The control cabinet with a touch screen for setting the sintering process parameters

When the sintering process is finished, the option of the matrix cooling starts using $P_{vac.gauge}=0,4$ bar vacuum-gauge pressure. This option guarantees a lower repeated shrinkage of the polystyrene pattern.

3.2. Description of the matrix

The matrix used in the research was designed to finish the specimens for the strength tests. It consists of stable and moving parts which are fixed to the table of the press. The construction of the matrix is presented in Figures 5 and 6. The matrix for polystyrene pattern making is made of aluminum.

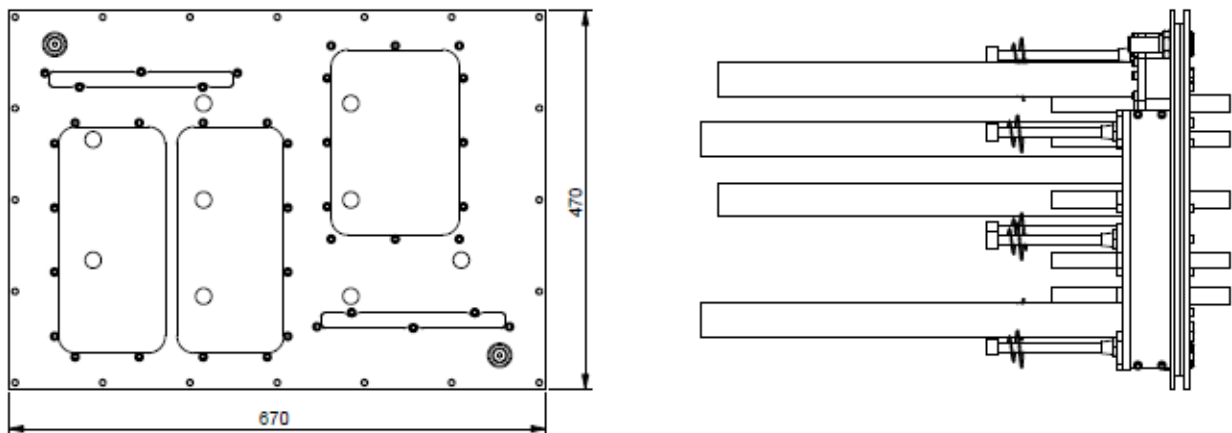

Fig. 5. The construction of the matrix fixed on the E.A. HEITZ 67269 automatic device [13]

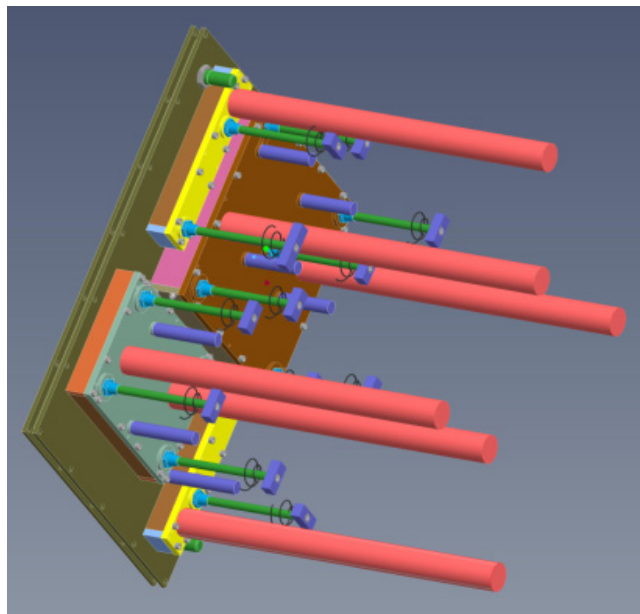

Fig.6. The construction of the matrix fixed on the E.A. HEITZ 67269 automatic device [13]

4. In-house research

4.1. The scope, aim and material for the research

Expanded polystyrene D933B produced by the Ineos Nova Company was used for the research. The bulk density of the polystyrene before the initial foaming was 620 kg/m^3 , granule diameter was within the range of $0.2\div 0.4 \text{ mm}$. The research involved the bending tests of the pattern made of the initially foamed polystyrene for the time of $t_s=90 \text{ s}$, pressure of $P_s=1.4 \text{ bar}$ and aged for 90 min. The bulk density of the foamed polystyrene was 22.7 kg/m^3 .

Then after the bulk density was determined the granulate was subjected to the process of the final shaping using the E.A.HEITZ 67269 automatic device in the autoclave option for the times $t_a=60\div 90 \text{ s}$ and the pressure of steaming $P_a=1,3\div 2.30 \text{ bar}$. For the abovementioned option the vacuum-gauge pressure was also used. It was $P_{\text{podc.}}= 0.4 \text{ bar}$. The time of the vacuum-gauge pressure activity was $t_{\text{podc.}}= 20\div 50 \text{ s}$. The final shaping process was conveyed in the autoclave option ($P_a=1.7 \text{ bar}$, $t_a=7 \text{ s}$) – steam passing option ($P_p= 1.5\div 2,3 \text{ bar}$, $t_p=2\div 8 \text{ s}$). For this option the vacuum-gauge pressure was $P_{\text{podc.}}= 0.4 \text{ bar}$ for the time $t_{\text{podc.}}=50 \text{ s}$

The research was aimed at determining the optimal pressure of polystyrene sintering using the autoclave option and using the

steam passing option. Then the comparative analysis of both options was carried out.

4.2. Bending tests stand

The stand for the tests is presented in Figure 7 and it is equipped with the TS-1 device suitable to determine the strength properties of expanded plastics. The stand allows determining the bending strength, compression strength and stretching strength. In the present work the bending test of the polystyrene specimens which meet the requirements of the PN-EN 12089:2000 norm was carried out.

There are two ranges of the force measurement used in the bending tests:

- from 10 N to 100 N,
- from 100 N to 1 kN,

precision of the force was 1% of the current registration.



Fig. 7. The stand for bending tests [14]

4.3. Methodology of the research

To make the specimens, a specially made matrix was used. It is shown in Figures 5 and 6. From the ready patterns the specimens with the dimensions of 150x28x22 were cut and then those were subjected to the bending tests to determine their strength. The diagram of the stand for strength tests is presented in Figure 7.

The bending strength was determined using the formula:

$$R_g = \frac{M_g}{W_x} = \frac{3Fl}{2bh^2} \quad (1)$$

where:

R_g – bending strength, [Pa];

M_{gmax} – bending moment, [N·m];

W_x – coefficient of the complete rectangular cross-section of bending, [m³];

F – breaking load, [N];

b – width of the specimen, [mm];

h – thickness of the specimen, [mm];

L – length of the specimen, [mm];

l – distance between the supporting rolls, [mm].

5. Result analysis

Table 1 presents the results of the measurements obtained during the tests on the TS-1 device for different times and pressures of the pattern shaping process using the autoclave option. The results of the measuring which meet the requirements regarding the resistance to bending of the models made using the Lost Foam technology were marked.

Table1.

Example results of resistance to bending measurements during the test using the TS-1 device for different times and pressures of the pattern shaping process in the autoclave option

Pressure of sintering P_a [bar]	Time of sintering t_a [s]	
	60	90
1.3	131	206.39
1.4	219	208.99
1.5	273	245.81
1.6	271	235.38
1.7	346	219.88
1.8	320	323.72
1.9	300	340.75
2.0	294	337.70
2.1	316.17	312.92
2.2	288.04	336.37
2.3	284.71	-

Figure 8 presents the influence of the pressure of sintering of the patters on its resistance to bending at a constant time which was $t_a = 60$ s. It follows from the presented data that the resistance to bending depends on the sintering pressure; the maximum resistance to bending was obtained when the sintering pressure was 1.7 bar. At higher pressures the specimens start contracting mildly and at longer times they are subjected to total deformation.

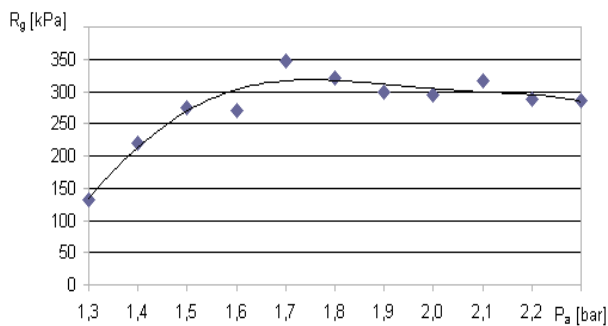

Fig. 8. The influence of the sintering time of the pattern on its resistance to bending at a constant time which is $t_a = 60$ s

The example photograph of the specimen and its breakage is show in Fig. 9.



Fig. 9. The specimen after the process of the final shaping

Table 2 presents the results of the measuring obtained during the tests using the TS-1 device for different times and pressures of the pattern shaping process in the option of passing the steam directly through the pattern for constant parameters of the autoclave $t_a = 7$ s and pressure $P_a = 1,7$ bar. The results of the measurements in the bending resistance tests which meet the requirements as for resistance to bending of the patterns obtained using the Lost Foam technology were marked.

Table 2.

Example results of the measurements of the resistance to bending obtained during the tests using the TS-1 device for different times and pressures of the pattern shaping process in the option of passing the steam directly through the pattern for constant parameters of the autoclave $t_a = 7$ s and pressure $P_a = 1,7$ bar

Pressure of the water steam passing through the pattern P_p [bar]	Time of passing the water steam through the pattern t_p [s]		
	2	5	8
1.5	185	258	222
1.7	259	285	405
1.9	311	303	390
2.1	355	390	435
2.3	348	320	469

Fig. 10 presents the influence of the pressure of the water steam passed through the pattern (the option of steam passing) on its resistance to bending at constant time which was $t_p = 5$ s and constant autoclave parameters which were $t_a = 7$ s and $P_a = 1.7$ bar. It follows from the presented results that the

resistance to bending depends on the pressure of the water steam passing, the maximum resistance to bending can be obtained at the pressure equal to 2.1 bar. At higher pressures the specimens are subjected to deformation.

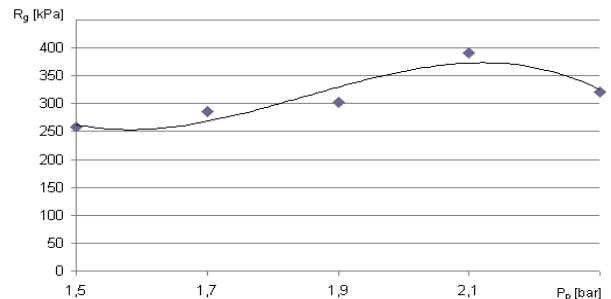

Fig. 10. Dependence of the resistance to bending R_g in the option of the passing steam pressure P_p , $R_g = f(P_p)$

Picture 11 presents the influence of the time of the steam passing through the pattern on its resistance to bending at constant pressure which was $P_p = 2.1$ bar and constant autoclave parameters $T_A = 7$ s and $P_A = 1.7$ bar. It follows from the presented data that when the time of the steam passing through the form increases, the resistance to bending of the pattern also increases.

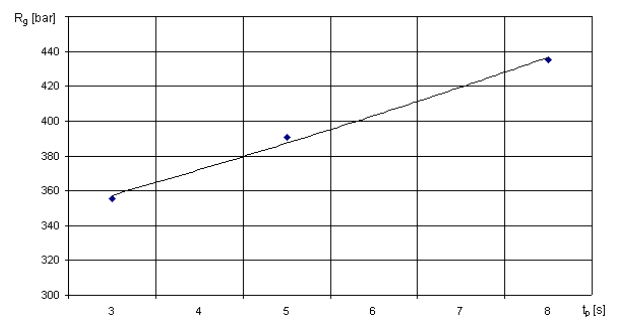

Fig.11. The influence of the time of the passing the water steam through the pattern on its resistance to bending at constant pressure which was $P_p = 2.1$ bar and constant autoclave parameters which were $t_a = 7$ s and $P_A = 1.7$ bar

6. Conclusions

It follows from the data presented in the current work that:

- the maximum resistance to bending of the pattern for the autoclave option was obtained at pressure 1.7 bar,
- by passing the steam directly through the pattern it is possible to reduce the pattern shaping process,
- the highest resistance properties were obtained using the option of pattern steaming for $P_p = 2.1$ and $t_a = 7$ s and $P_a = 1.7$ bar.

- for both options used, the results of bending resistance were similar, however for the option of steam passing the time is much shorter.

For the plants where the polystyrene patterns are mass produced it would be more beneficial to use the automatic devices with the option of passing the steam through the pattern which would allow shortening the pattern making time.

References

- [1] Shroyer H. F. (1958). US Patent No 2, 830, 343, 1958.
- [2] Clegg A. J. (1986). Expanded-polystyrene Moulding – a Status Report. *Foundry Trade Journal International*. June 1986. 51-69.
- [3] Pacyniak T. (2006). Theoretical and technological basics of the process of cast making using the full-cast molding. *ZN PŁ. 985*. Technical University of Łódź: Łódź. (in Polish).
- [4] Bailey R. (1982). *Modern Casting*. 72, 4, 58.
- [5] Pacyniak T., Kaczorowski R. (2010). Investigations of polystyrene pre-expansion process by use of test stand equipped with batch pre-expander. *Archives of Metallurgy and Materials*. 55 (3/2010), 883-888.
- [6] Pacyniak T., Buczkowska K., Kaczorowski R. (2011). Influence of time and pressure of forming a pattern on mechanical properties. *Archives of Foundry Engineering*. 11 (S13), 151-156.
- [7] Lost Foam Casting – shaping up to the future. A revive of the polystyrene moulding technology from Foseco. (1986). *The British Foundryman*. 79, 12, 466.
- [8] Gniewaszewski E. (2010). The analysis of the process of pattern shaping at experimental stands. Diploma paper under the supervision of T. Pacyniak, DME&PS Technical University of Łódź (in Polish).
- [9] Brown J.R. (1988). Proceedings of The American Foundrymen`s Society Conference: Evaporative Foam Casting Technology III, 159.
- [10] Pacyniak T. Kaczorowski R. (2003). The analysis of the properties of the fire resistant coating applied on the *Zeszyty Naukowe Nr 985*. Technical University of Łódź 2006 (in Polish).
- [11] Pacyniak T. (2008). Polystyrene patterns when making the casts using LOST FOAM method. *Archives of Foundry*. 8, 147-155. (in Polish).
- [12] Pacyniak T. (2008). The effect of refractory coating permeability on the Lost Foam process. *Archives of Foundry Engineering*. 8 (3), 199-204.
- [13] http://www.heitz.de/fileadmin/user_upload/HEITZ_brochures/HEITZ_Evolution_2010_EN.pdf of 05-21-2012.
- [14] Technical documentation of the company SchaumaPlast Organica (in Polish).
- [15] Technical documentation of the TS device from LAB-TRADE (in Polish).