

Recovery braking of variable-structure electronic commutator for BLDC motor

TOMASZ BISKUP

*Faculty of Electrical Engineering
Silesian University of Technology
Krzywoustego 2, 44-100 Gliwice, Poland*

e-mail: tomasz.biskup@polsl.pl

(Received: 04.04.2012, revised: 27.06.2012)

Abstract: Permanent magnet motors are more and more frequently used in various applications. In this group motors with a trapezoidal EMF deserve a special attention. They are characterized by a simple construction, high efficiency and high torque overload. A certain drawback of BLDC motors are difficulties with an operation at a speed above the nominal value. The article presents the results of investigations into the variable-structure electronic commutator designed for the drive of a small electric vehicle equipped with BLDC motors. Such a solution allows extending the standard range of the drive's speed. The considerations contained in the article focus on the possibilities and effects of regeneration mode in the proposed topology of converter. A theoretical analysis has been presented as well as computer simulations carried out by means of Matlab-Simulink, which were then verified at a laboratory. The tests were finished with trials conducted using a small electric vehicle Elipsa.

Key words: power electronics, BLDC motor, electronic commutator, electric vehicle

1. Introduction

Investigations carried out in the last decade in the area of magnetic materials' technology enabled implementing the production of improved types of electric machines. One of the areas marked by a particularly noticeable progress is that related to permanent magnet motors. These motors, using permanent magnets based on rare earth elements, are more and more widely applied. Typically, they are divided according to the air-gap field distribution into two groups [1]:

- brushless direct current motors (BLDCM) characterized by a trapezoidal electromotive force and
- synchronous motors (PMSM) characterized by a sinusoidal electromotive force induced in windings.

The BLDC and PMSM motors are usually used as auxiliary drives in the automotive industry (cooling liquid pump, wipers' drives etc), in household appliances or as the main drive of the main drive in electric and hybrid cars [2].

Apart from the higher unit price, a certain drawback are problems connected with the work of permanent magnet motors above the rated speed. Operating in the area with a weakened field in the air-gap is more difficult, because the motor's induction is forced mainly by permanent magnets which parameters are practically constant. This problem is particularly visible in the case of BLDC motors, in which magnets are usually located on the rotor surface.

The problem of increasing the working range of BLDC motors' speeds can be solved by:

- increasing the supply voltage [3],
- modification of the motor construction/windings [4],
- modification of the structure of converter which supplies the motor [5].

This article concerns the last above mentioned possibility and focuses mainly on the conditions of the converter's drive work during recovery braking. It is an important problem in the majority of drives, especially traction ones – for example electric vehicles. Recovery braking not only enables the energy to return to the source (battery, supercapacitor), but it also allows the driver to take control over the vehicle, which is known as the effect of engine braking in vehicles equipped with combustion engine drives [2].

2. The electronic commutator

A typical converter allowing a BLDC motor to be properly supplied is an electronic commutator shown in Figure 1a [1]. The proposed variable-structure electronic commutator, presented in Figure 1b, allows extending the range of rotational speed above the rated value, with a reduced maximum load torque in this area [5, 10]. It contains a part compliant with the classic commutator topology as well as additional elements enabling the converter to be switched over and work in the half-bridge mode.

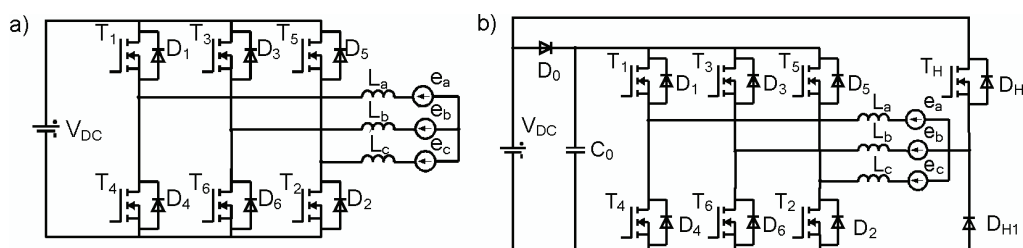

Fig. 1. BLDC motor with (a) full-bridge electronic commutator and (b) variable structure electronic commutator

Motor work with a full-bridge converter is a standard solution. Exceeding a certain speed which approaches the idle run speed is followed by switching to a half-bridge configuration. The properties of a BLDC motor operating in the half-bridge configuration is presented in [6, 7]. The idea of the system operation is based on the fact that the flux matched with the active stator windings in case of the motor operating in the full-bridge configuration is twice as great as in the motor operating in the half-bridge configuration. Owing to that, it is possible

to obtain two mechanical characteristics of the motor. The first one is for the commutator operating in the full-bridge configuration and the second one for the half-bridge configuration – Figure 2.

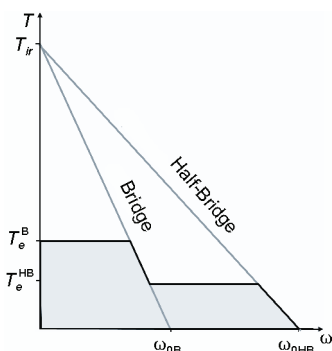

Fig. 2. The torque-speed characteristic for a PM BLDC motor drive with the bridge and half-bridge stator configuration

The mechanical characteristic of a motor can be described by the following relation:

$$\frac{\omega}{\omega_0} = 1 - \frac{T_e}{T_{tr}}, \tag{1}$$

where: ω_0 – speed value for idle run, T_{tr} – motor torque for stand-still condition, ω – speed value, T_e – torque developed by a motor.

The stand-still torque is the same for both structures and approximates:

$$T_{tr} = \frac{V_{DC}}{R_s} K_f, \tag{2}$$

where: R_s – value of stator phase resistance, K_f – value of phase excitation factor, V_{DC} – voltage applied to the motor’s terminals.

The idle run speed for the full-bridge ω_{0B} and half-bridge ω_{0HB} structure motor operation can be presented respectively as:

$$\omega_{0B} = \frac{V_{DC}}{2K_f} \tag{3}$$

and

$$\omega_{0HB} = \frac{V_{DC}}{K_f}. \tag{4}$$

A more thorough discussion on the properties of the drive has been presented in [8, 9].

In order to implement both structures, a special topology of a converter with additional switches has been proposed [5, 10]. In Figure 1b the BLDC motor is represented by elements of an equivalent circuit: back-EMF e_a, e_b, e_c , and stator phase inductances L_a, L_b, L_c . In the

converter we can distinguish a basic structure with six transistors T_1 - T_6 and additional elements: a capacitor C_0 with a diode D_0 , a transistor T_H and a diode D_{H1} . The transistor T_H connects the positive terminal of the supply source with the motor windings Y-point, which allow to switch to the half-bridge structure and the motor current control. The additional elements are auxiliary and ensure correct operation in the half-bridge configuration. The functions of these elements are thoroughly discussed in [8]. The basic condition for this converter implementation is to use a 3-phase BLDC motor with Y-configurations and available star point.

3. The operation principle of variable structure commutator

3.1. Motoring operation

During the bridge structure operation the commutator switches are controlled in a standard method as shown in Figure 3a [1]. The transistors T_1 - T_6 are switched in cycles based on the signals coming from the rotor position sensor. At that time the transistor T_H remains turned off.

Another function of the transistors is to control phase currents. It is done by the master regulator that generates a PWM signal. This signal can be applied to the control signals of T_1 - T_6 transistors by the logical AND operation. Not all the transistors need to be used as motor currents' regulators. A similar effect can be obtained by controlling the current by means of only one group of transistors – positive (T_1, T_3, T_5) or negative (T_2, T_4, T_6). It reduces ripples of the motor currents. In many applications the bootstrap drivers [12] of transistors are used. Hence, it is recommended to use a PWM signal for the positive group transistors – Figure 3a.

In order to switch the inverter into the half bridge structure, the transistor T_H should be turned on by the PWM signal. The same signal is used to control the positive group transistors (T_1, T_3, T_5). The way of tripping the transistors T_1 - T_6 is not changed. These are presented in Figure 3b. The activated transistor T_H takes control over the motor's currents in place of the positive group transistors. The motor currents become unipolar and flow through the circuits controlled by the transistor T_H and the negative group transistors (Fig. 4a).

During such work there are two commutation circuits in the system. The first one is connected with the switching off of the transistor T_H in accordance with the PWM cycle. In that cycle current flows through the circuit of diode D_{H1} , motor winding and a switched-on transistor of the negative group (Fig. 4b). The second commutation circuit is related to the switching of the motor windings by the transistors T_2, T_4, T_6 depending on the actual value of the rotor position angle Θ .

When a given transistor of the negative group is turned off, the current of the phase that is switched off drops to zero. The energy accumulated by the motor inductance is discharged in the circuit that consists of:

- if the transistor T_H is switched on – supply voltage V_{DC} , transistor T_H , motor winding, one of the diodes (D_1, D_3, D_5) and the capacitor C_0 (Fig. 4c);
- if the transistor T_H is switched off – diode D_{H1} , motor winding, one of the diodes D_1, D_3, D_5 and the capacitor C_0 .

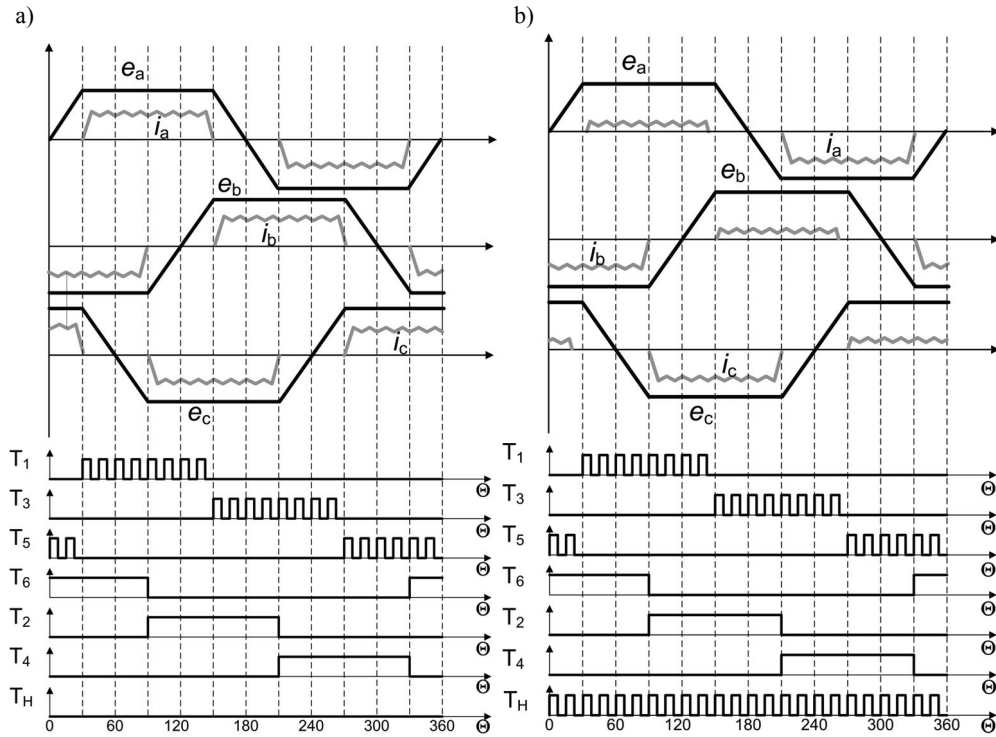

Fig. 3. Motor operation – back EMF, current and transistor switching signals waveforms for: a) bridge, b) half-bridge

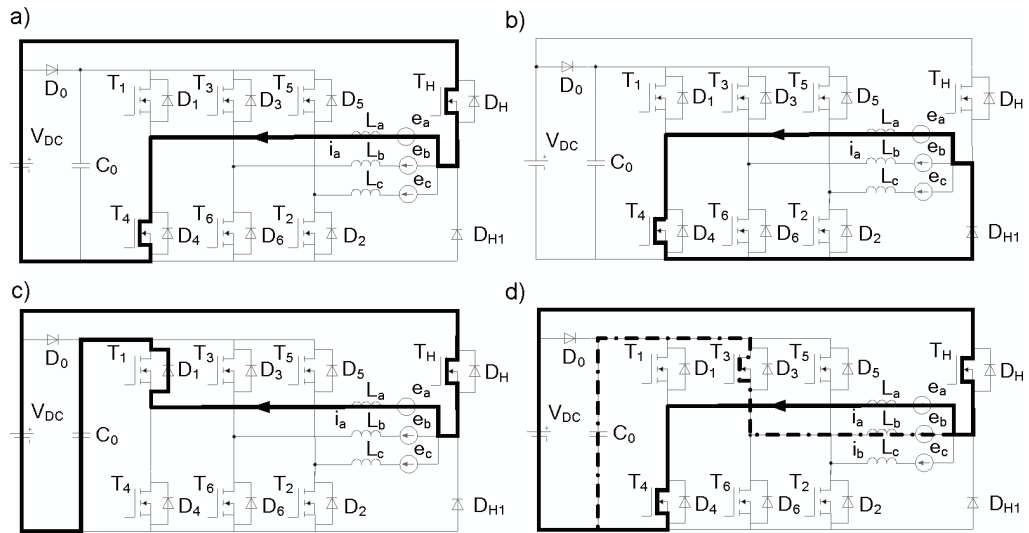

Fig. 4. Equivalent circuit of variable-structure electronic commutator: a) transistors T_H , T_3 , T_4 are on, for $v_{C0} < V_{DC} + e_b$; b) transistors T_H and T_3 are off, T_4 is on, c) transistor T_H is on and transistor T_4 is off, d) transistors T_H , T_3 and T_4 are on, for $v_{C0} > V_{DC} + e_b$; motor operation in the half bridge structure

The current flow during this commutation leads to an increase the capacitor voltage. That controlled increase of voltage has a positive effect on the operation of the drive at a rotational speed higher than nominal, when motor terminal voltage rises above some maximum value, which is approximately equal to voltage V_{DC} . In this situation an uncontrolled current flow from the motor windings to the capacitor is blocked. It would lead to a dynamic braking of the motor, disturbing the operation above nominal speed as a result. It is important that the capacitor C_0 voltage increases in advance with reference to the voltage induced at the motor terminals. In order to prevent the capacitor from overloading, proper transistor of the positive group of the bridge is switched on. When the capacitor voltage v_{C0} reaches the value of:

$$v_{C0} > V_{DC} + e \quad (5)$$

an additional current flows in the circuit which is marked with a dashed line in Figure 4d. This current discharge partially the capacitor C_0 and its amplitude is lower than the amplitude of work current. The current value is controlled by the switching of positive group transistors, and its flow generates an additional torque developed by the motor. As a result, phase currents of the motor operating in the half-bridge structure are not quite unipolar (Fig. 3b). In the phase current two components can be shown: first – the work current and second – the current connected with voltage control on the capacitor C_0 . During the drive operation the capacitor C_0 voltage can obtain a maximum value which is approximately twice as high as the supply voltage V_{DC} .

3.2. Braking operation mode

One of the requirements set for an electric vehicle drive system is the possibility of recovery braking. Problems related to the choice of an optimal braking strategy in an electric vehicle have been described in [2]. The maximum value of motor torque during electric braking usually needn't be equal to the value obtained during the motor's work. In vehicles equipped with hydraulic brakes it is enough to ensure electric braking with a constant low torque, giving the vehicle driver a sense of safety and comfort, like in the case of a vehicle with a combustion engine drive.

Work in regenerative mode in the bridge structure is obtained by special control of the commutator's transistors. One group (positive or negative) transistors are switched cyclically on the basis of position sensors signals in such a way that the current flowing through the motor's windings has opposite polarization in relation to phase EMFs. The second group transistors are permanently switched off – Figure 5. Owing to that, when an appropriate transistor is switched on, the current flow is forced by EMFs in the circuit of motor's two windings, the turned-on transistor and the freewheeling diode of the neighbouring phase transistor (from the same group). After the transistor has been turned off, the circuit is broken, while the energy accumulated in the motor's inductances is discharged to the supplying source by the internal transistor diodes.

A variable structure commutator – Figure 1b – contains additional capacitor C_0 and diode D_0 , which blocks the possibility of direct energy flow from the motor to the supply source, as is the case in a classic bridge system. For this reason, other elements of the converter and the

different method of transistor control are used during regenerative mode. Controlling consists in blocking the transistors of the commutator's negative group during braking, whereas the commutator's positive group transistors are switched in the same way as in the case of a standard bridge. With such procedure, the currents flow at the time of switching on the transistors ensures the possibility of braking. The system is also secured against excessive increase of voltage on the capacitor C_0 . Examples of current flow circuits during braking with the transistor T_1 turned on and turned off have been shown in Figure 6 and 7.

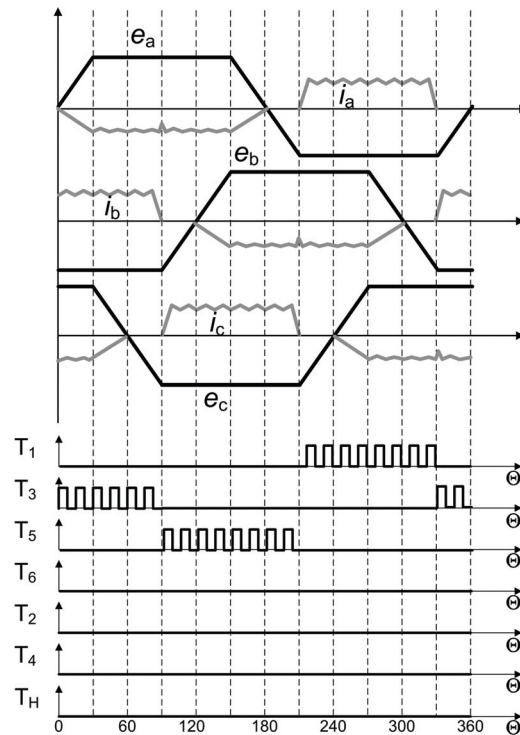

Fig. 5. Regenerative mode, back EMF, current and transistor switching signals waveforms, bridge structure

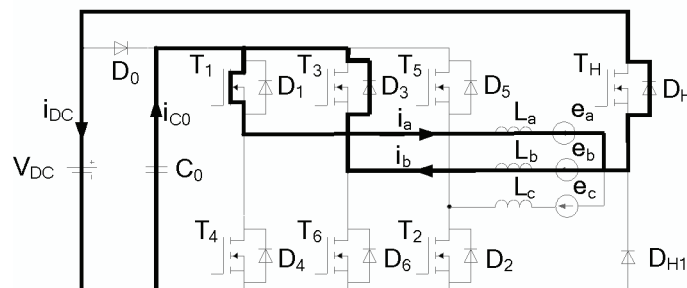

Fig. 6. Equivalent circuit of the converter during braking operation: T_1 is on

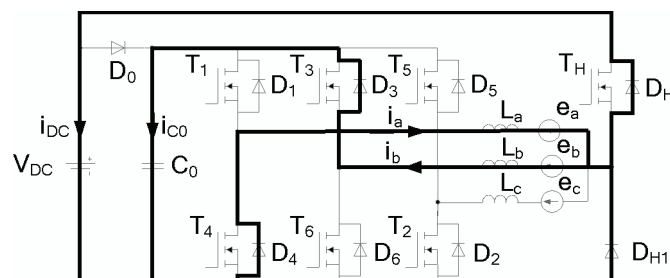

Fig. 7. Equivalent circuit of the converter during braking operation: T_1 is off

Currents flow at the moment the transistor T_1 is switched on is presented in Figure 6. In such an operation mode, depending on the value of voltage on the capacitor C_0 and phase EMF, the following dependences may occur after the transistor T_1 has been switched on:

$$\begin{aligned}
 \text{a)} \quad & i_a = i_{C0} = -i_{DC}, i_b = 0, \quad \text{if } v_{C0} > V_{DC} + e_a, \\
 \text{b)} \quad & i_a = i_{C0} - i_b, i_{C0} = -i_{DC}, \quad \text{if } v_{C0} < V_{DC} + e_a, \\
 \text{c)} \quad & i_a = -i_b, i_{C0} = 0, i_{DC} = 0, \quad \text{if } v_{C0} \cong V_{DC}.
 \end{aligned} \tag{6}$$

After the transistor T_1 has been switched off, the current i_a decays, flowing to the source V_{DC} , while the current i_b decays charging the capacitor C_0 and increasing the voltage v_{C0} . The currents flow after switching off the transistor T_1 has been shown in Figure 7. Figure 8 presents curves of motor phase currents and voltages on the capacitor v_{C0} during a complete cycle of work: start-up and work in the bridge structure, switching over and work in the half-bridge structure as well as electric braking until the drive is stopped. The waveforms were obtained by Matlab-Simulink model of the drive. In order to accelerate the process of numerical calculations, the moment of inertia in the simulated system was reduced several times.

The regenerative mode starts with the range A in Figure 8. Globally, during braking the amplitude of the positive and negative pulses of currents flowing through the motor windings can be different. In a special case braking may take place in the conditions of a quasi-unipolar current flowing only through one phase of the motor – range A – current i_a . The average value of the current returned to the source i_{DC} also is changing – Figure 9.

In the initial phase of regenerative mode of the motor working at a maximum rotational speed the total current flowing through the motor's active winding is transmitted to the source (battery). As the motor's speed decreases, the braking energy oscillates between the motor, the capacitor C_0 and the battery. In the waveforms shown in Figure 10 one can notice negative motor phase currents (i_a, i_b). These currents have lower amplitude than positive currents. The waveform of the i_{DC} source current also implies that in this range of electric braking only a part of energy is returned to the source. There are two kinds of braking: recovery and dynamic.

In the final phase of electric braking, when the motor currents become symmetric and bipolar, the motor brakes dynamically, so all the energy is dispersed in the motor's and commutator's circuits – Figure 11.

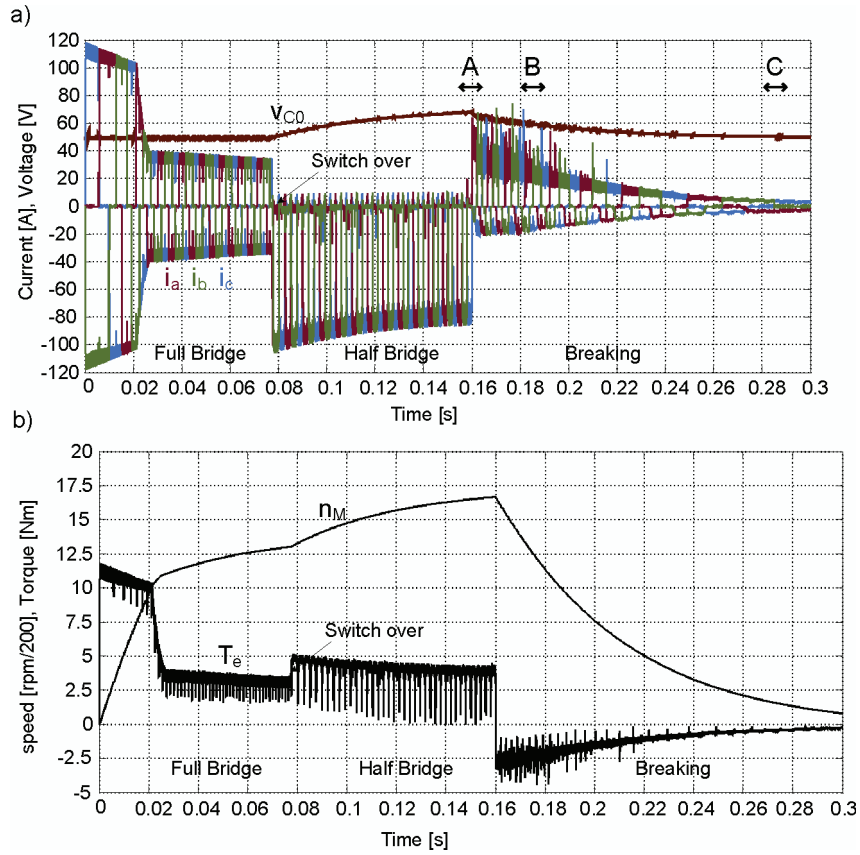

Fig. 8. Matlab simulation – waveforms of: a) motor currents, voltage on the capacitor v_{C0} , b) speed n_M and torque T_e developed by a motor

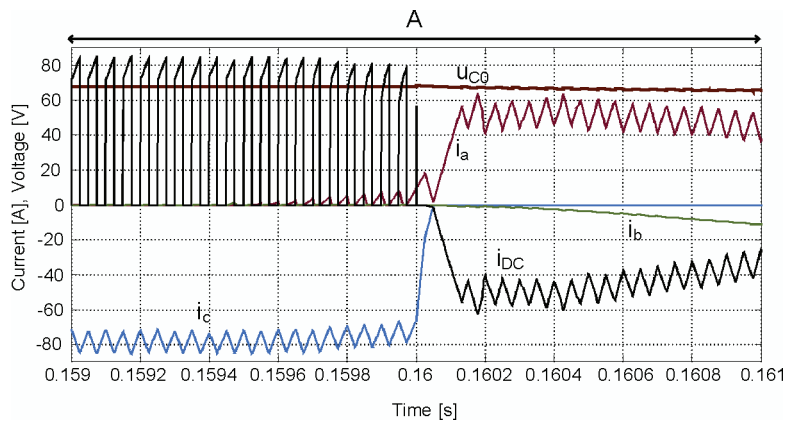

Fig. 9. Zoomed-in waveforms from Figure 8a – range A

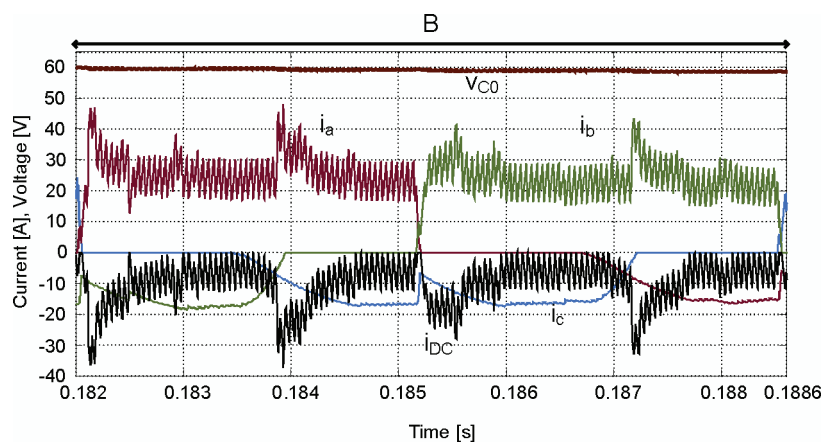

Fig. 10. Zoomed-in waveforms from Figure 8a – range B

In general, as the motor's speed drops, the participation of dynamic braking increases, and in consequence the value of current flowing to the source is reduced. In the curves of motor currents the value of negative currents grows and in the final stage of braking these currents become bipolar and symmetric. In this state only the motor's dynamic braking is present and the current flowing to the source equals zero, as shown in the Figure 11.

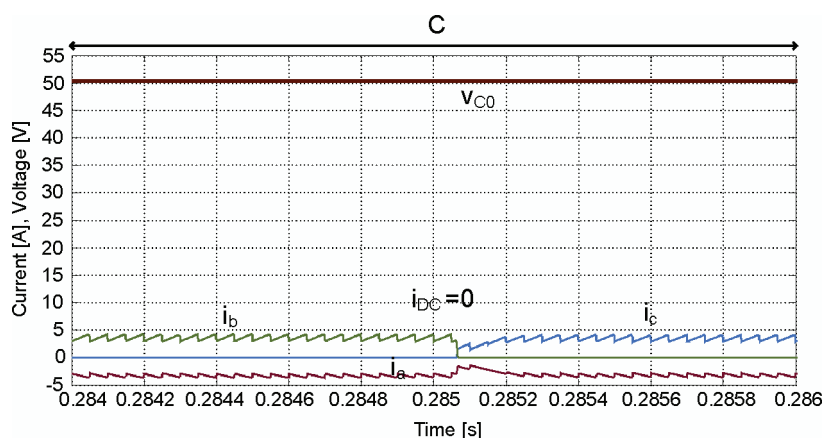

Fig. 11. Zoomed-in waveforms from Figure 8a – range C

Changeable values of positive and negative motor's currents during electric braking might make it difficult to maintain a stable value of the torque developed by the motor. In an extreme case this could lead to uncontrolled oscillations of the torque. In order to maintain a stable value of the torque, in the current control block the measured signals of currents from each phases should be separated into a positive and negative polarization part and then summed up. The so obtained signal of the measured value ensures proper work of the current (torque) regulator during electric braking – Figure 8b.

4. EV drive system

In order to test the proposed system of a variable structure commutator, a converter for two BLDC motors has been built. It was assumed that its target application would be the drive of a small electric vehicle. The electric vehicle Elipsa, which is shown in Figure 12 and presented in more detail in the study [10], has been used as a subject of investigations. The vehicle is driven by means of two 2 kW BLDC motors which idle run speeds is 3000 rpm in a classic commutator version and supply voltage of 48 V. With the transmission gear ratio 10:1 and appropriately selected wheels, the maximum linear speed of the vehicle is 25 km/h. The Elipsa belongs to the group of slow-speed vehicles which do not require registration.

The power circuits of the converter with two independent commutators, a diagram of which is shown in Figure 1b, have been designed and made using ThermalClad® technology – Figure 13. The one-sided printed circuit board (PCB) with a thickened layer of copper are prepared for the BLDC motor currents up to 150 A. The applied technology allowed to use MOSFET IRFS 4310 transistors mounted on the surface of PCB as a switches of the both electronic commutators (SMD technology).



Fig. 12. A two-person version of Elipsa vehicle with a luggage boot

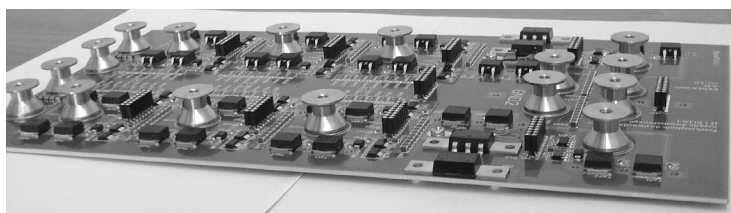

Fig. 13. A photograph of the power circuits of the tested converter

In each branch of the commutator there are two transistors connected in parallel. Thanks to the thermal conducting ceramic layer, the heat generated in the switches is very efficiently transmitted to the radiator, on which the PCB is mounted. This way are cooled not only transistors and diodes of converter but also connections between them. The terminals visible in Figure 13 allow both motors and the supplying battery to be connected. Apart from the power

board, there are capacitors C_0 of both electronic commutators, which due to their physical dimensions could not be placed directly on the PCB.

Measurement and driver systems are contained on an additional board placed above the main circuits. The control system was built using a digital signal controller (DSC) TMS 320F2812 [11]. This chip is a specialized processor for applications in the area of electric drives and process automation. The control program has been written in C language and covers all tasks related to the proper operating of a drive system, control, visualization and diagnostics. A schematic diagram of the implemented control system has been presented in Figure 14.

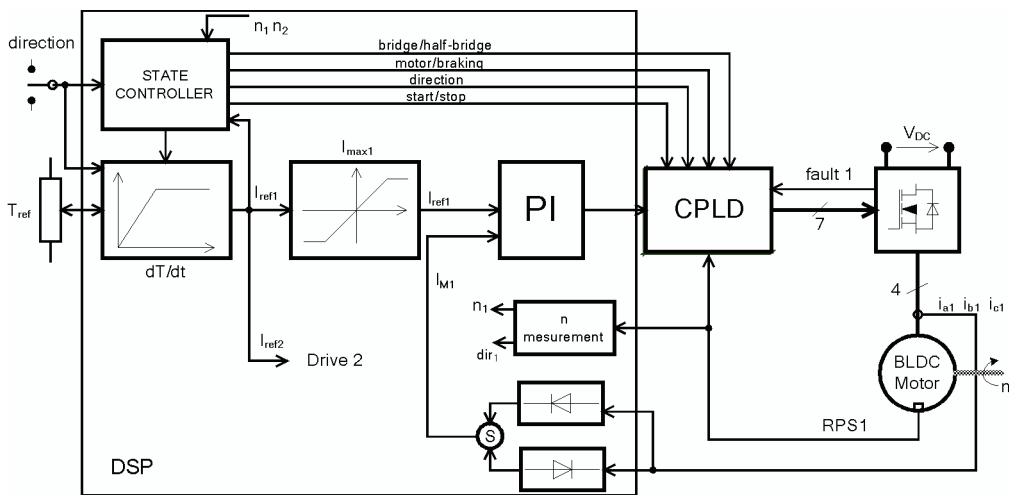

Fig. 14. A schematic diagram of the implemented control system

The value of torque T_{ref} set by the vehicle driver is transmitted from the accelerator pedal to the ramp block setting the value of the reference current amplitude for both motors. The block not only moderates the speed of changes I_{ref} , but also allows a forced modification of values when the converter structure (bridge/half-bridge) and the operation mode (motor/braking) is changed. The reference current value is also limited on a level determined by rotational speed and the temperature of the converter. The currents are regulated by means of a classic PI regulator, which generates the output value of PWM signal for switches control. The generation of control signals T_1 - T_6 and T_H transistors on the basis of the rotor position sensors (RPS) and PWM signal is a task of an additional CPLD, with implemented combinational logic, as shown in Figures 3 and 5. The logic formulas are dependent on the state of commutators' work, hence appropriate feedbacks from the state controller system. For the sake of improved legibility, in Figure 14 an identical control path for the commutator and motor number 2 has not been shown.

A linking element between the microprocessor system and the commutators' MOSFETs are drivers. In order to simplify the construction of this part of the converter, IR 2130 drivers using the bootstrap technology have been applied [12] – Figure 15.

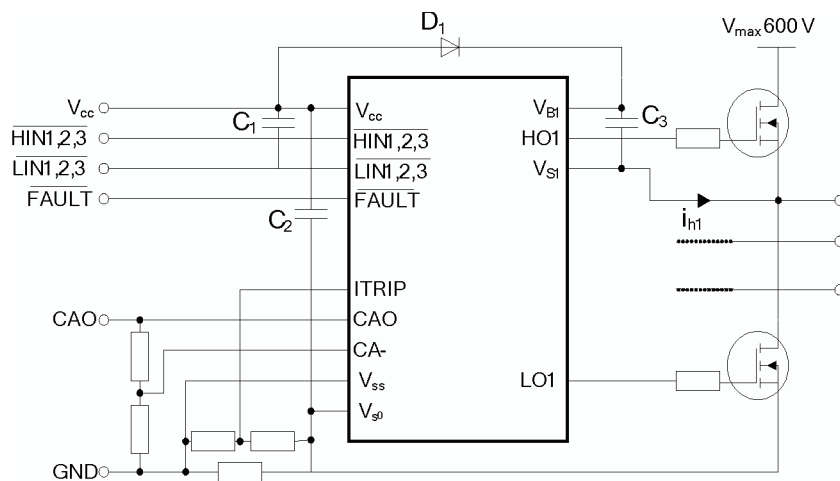

Fig. 15. A diagram of an application of a transistor half-bridge with a driver IR 2130 [12]

In the case of the transistors control method applied in the study, which has been described in the previous chapter, an additional problem appears during electric braking. It results from the fact that in this control mode, the positive group transistors are periodically switched on/off, while the negative group transistors are permanently switched off – Figure 5.

The driver using the bootstrap technology makes it possible to control the transistors of half-bridges without additional supply voltage sources for the upper switches by building in artificial voltages based on additional external capacitors (C_3). These capacitors are charged each time by appropriate diodes (D_1) when complementary transistor of the negative group is being switched on. It allows maintaining the energy necessary to control the gates and switch on/off the positive group transistors. An example has been shown in Figure 15 – the switching-on of one of the negative group transistors (LO1) causes a flow of current i_{h1} in the circuit: source V_{cc} , diode D_1 , capacitor C_3 , load, a switched-on transistor of the negative group. Such a solution considerably simplifies the transistor drive system and at the same time requires periodically switching of the lower transistors in a control algorithm. In the case of a variable structure commutator, during electric braking the bridge positive group transistors are switched, while the negative group transistors and transistor T_H are turned off. As a result, charging of the driver system capacitors is not ensured, which will lead to turn gate signals off, and in consequence to disturbed work of the converter during braking. This results from the fact that the IR2130 driver turn off the control signal for a positive group transistor, if respective supply bootstrap voltage is too low (lower then 9 V).

To counteract this phenomenon, it was proposed to control the commutator’s switches in a way enabling work with electric braking [13]. This method requires the braking operation mode and motor operation mode to be periodically switched over. The time of the motor’s operation is very short (1 ms) in relation to the time of braking operation (1 s) and is not perceptible in the motor’s torque ripple and vehicle vibrations. Additionally, in the motor’s operation range the current reference value for the regulators equals 0. At the same time 1 ms is

enough to charge bootstrap capacitors (C_3), because in the motor operation mode one transistor of the negative group is always turned on – Figure 3.

5. Measurements

The system of a single electronic commutator has been initially tested in laboratory. A workplace with a mounted target BLDC motor connected with a load through a measurement system with a torque-meter has been prepared for investigations. Figure 16 shows the curves of BLDC motor current, voltage on capacitor C_0 and speed of the motor during a work cycle. It starts in the bridge structure. At the moment A, after the reference current has been reduced to 0, the control system switch to electric braking. In this mode the reference value of motor current is constant, and the current curves are quasi-bipolar. Braking causes a return of energy and its fluctuation between capacitor C_0 and the motor, which is reflected in a temporary increase of voltage on C_0 . The braking torque reduces the speed of the motor until it stops.

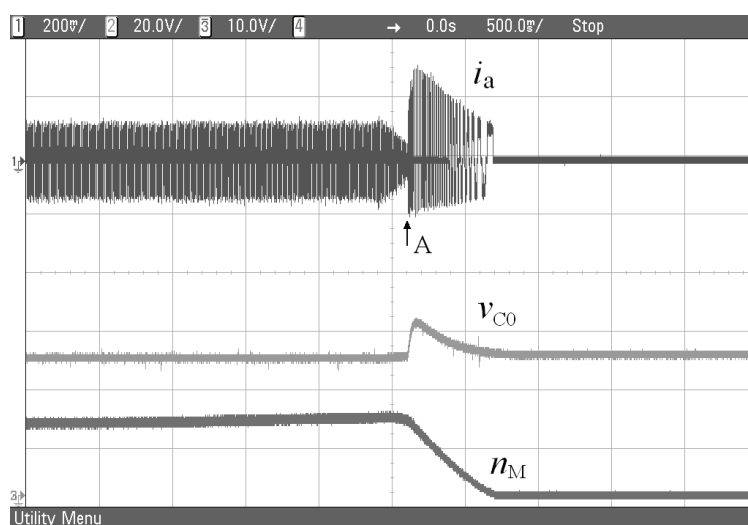

Fig. 16. Electric braking in the bridge structure, motor current i_a , voltage on C_0 v_{C_0} , motor's speed n_M , current scale 20 A/div, voltage scale 20 V/div, speed scale 2000 rpm/div, 0.5 s/div

A similar situation are presented in Figure 17, but in the starting point the commutator worked in the half-bridge structure, and the motor is still increasing its rotational speed. In point B the reference current is reduced to 0 and after a while electric braking begins with a constant current value. Voltage on capacitor C_0 is smoothly reduced during braking. The first period current is quasi-unipolar, at the same time a lot of energy is returned to the battery. After reducing the motor's speed the motor's currents become quasi-bipolar, and the braking has a dynamic nature. The final value of voltage on capacitor C_0 is the same as supply voltage from the battery.

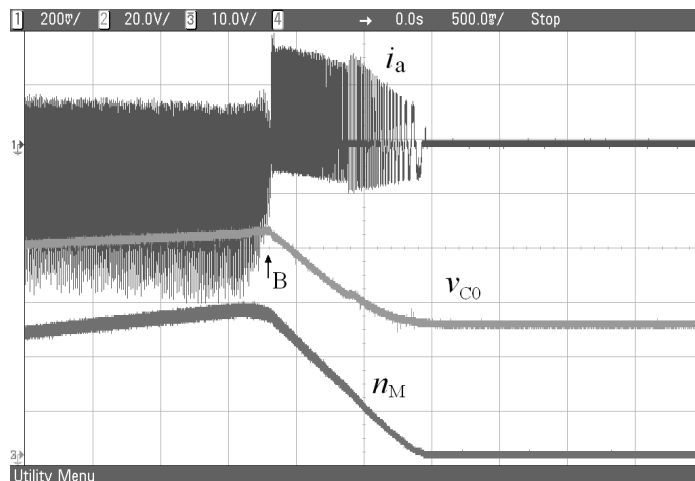

Fig. 17. Electric braking in the half-bridge structure, motor current i_a , voltage on C_0 v_{C0} , motor's speed n_M , current scale 20 A/div, voltage scale 20 V/div, speed scale 2000 rpm/div, time scale 0.5 s/div

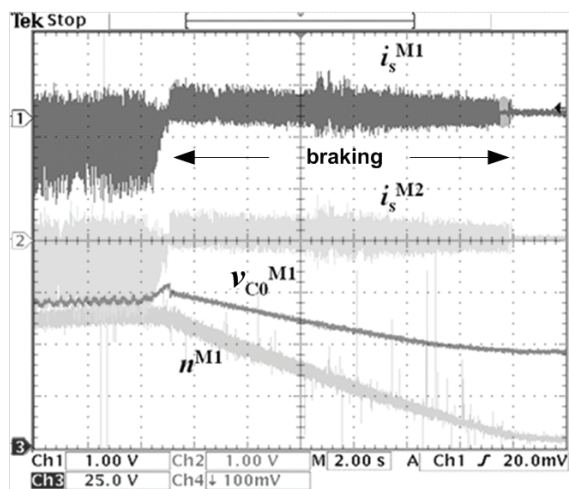

Fig. 18. Waveforms of both motor currents: i_s^{M1} , i_s^{M2} , voltage on capacitor v_{C0}^{M1} and motor speed of motor no1 n^{M1} , while EV decelerates from speed 35 km/h to 0; current scale 100 A/div, voltage scale 25 V/div, motor speed scale 1600 rpm/div, time scale 2 s/div

In the second stage of investigations the Elipsa vehicle was used [10]. The control system performed all the functions related to the proper operating of the two-motor drive. Figure 18 presents the process of the vehicle's braking. After the accelerator pedal has been released, electric braking begins. The reference current is reduced to zero, and next the system is switched over by the state controller to the braking operation mode. The selected value of the

reference current (25 A) gives an impression of control over the vehicle (braking torque), similarly to engine braking in a vehicle with a combustion engine drive. The current waveforms are in the beginning asymmetric. It is worth noticing that the process of the commutator's capacitors discharging is smooth and there are no noticeable abrupt changes in voltage $v_{C_0}^{M1}$. This results from the fact that during braking the energy is transmitted from the rotating motor to the capacitor C_0 and next from the capacitor to the battery.

Figure 19 shows the obtained waveforms of the vehicle's speed and electric power taken from the battery during a test drive. At that time the vehicle travelled at various speeds along the route, accelerated and decelerated – in total it covered a distance of 20 km. On the waveform of power taken from the battery (Fig. 19b) there are visible moments of recovery braking when the energy is returned to the source. The ratio of power returned to the battery to the power drawn during the test drive shows that only a small amount of energy can be recovered this way. At the same time the peak power returned from both motors did not exceed 1.5 kW at any moment. A slightly bigger gain could be obtained by additionally coupling the mechanical brake pedal with the control system and by increasing the value of the braking current in such a state. However, this requires allowing a temporary return of a considerable amount of current to the battery, which is not tolerated by many energy sources.

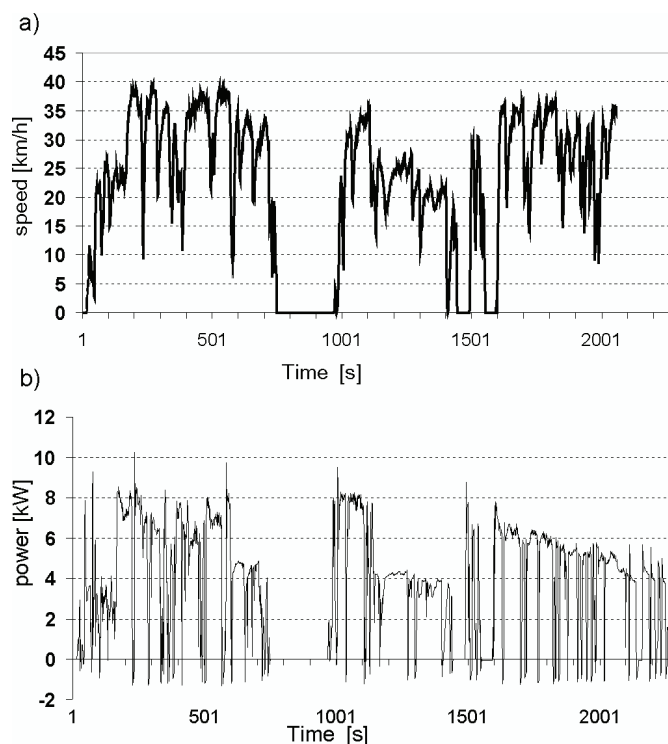

Fig. 19. A measurements from the EV test trip: a) EV speed, b) power drawn from the battery

6. Conclusions

The developed and tested dual-motor variable structure drive enables the range of a vehicle's speed to be increased maximally two times, without any necessity to exchange drive motors. The increased speed range was achieved solely by changing the structure of the commutator's power circuits and by proper control. It was also proved that in such a structure it is possible to obtain electric braking with a partial return of energy to batteries. This was achieved by using an external diode of transistor T_H and an appropriate control algorithm.

Worth emphasizing is the confirmation of the possibility to use a bootstrap driver in the new topology commutator, which considerably simplifies the construction of a part of the converter. It was also shown that such a system for the motor's and electric braking mode can operate properly within the whole range of rotational speed.

In the process of the project implementation two main problems were encountered. The first one was the achieving of braking with energy recovery. This problem was solved by using an additional diode in the power circuits of converters and the application of an appropriate algorithm of commutators switches control. The second problem was related to the blocking of transistor signals through the IR 2130 driver's system, which occurred during electric braking. This phenomenon resulted from the principle of operation of the driver system using the bootstrap technology method and the construction of converters. It was shown that this difficulty could be eliminated by appropriate switching of the modes of converter's transistors control in a cycle: braking→motor's work→braking. The solutions of both problems were registered for patent protection [13].

Within the framework of the study, simulation and laboratory tests were conducted. The main part of tests was carried out using the prototype electric vehicle and new topology electronic commutator. The tested electric car covered a total of ca 500 km. During the tests the optimal traction characteristics of the drive were finally verified and determined. A maximum linear speed of 37 km/h was obtained. This corresponds to a 50% increased range of the vehicle's speed with unchanged parameters of the motors.

References

- [1] Krishnan R., *Electric Motor Drives. Modeling, Analysis, and Control*. Prentice Hall (2001).
- [2] Ehsani M., Gao Y., Gay S.E., Emandi A., *Modern Electric Hybrid Electric, and Fuel Cell Vehicles – Fundamentals, Theory, and Design*. CRC Press (2005).
- [3] Bajec P., Voncina D., Miljavec D., Nastran J., *Bi-directional power converter for wide speed range integrated starter-generator*. Proc. of the IEEE International Symposium on Industrial Electronics ISIE 2: 1117- 1122 (2004).
- [4] Lawler J.S., Bailey J.M., McKeever J.W., Pinto J.O.P., *Extending the Constant Power Speed Range of the Brushless DC Motor Through Dual-Mode Inverter Control*. IEEE Trans. Pow. Electron. 19(3): 783-793 (2004).
- [5] Krykowski K., Bodora A., *Variable structure bridge/half-bridge electronic commutator for PM BLDC motor supply*. Proc. of the IEEE International Symposium on Industrial Electronics ISIE, pp. 905-910 (2005).
- [6] Krishnan R., *A novel single-switch-per-phase converter topology for four-quadrant PM brushless DC motor drive*. IEEE Tran. Ind. Appl. 33(5): 1154-1161 (1997).

- [7] Krishnan R., Lee S., *PM brushless DC motor drive with a new power-converter topology*. IEEE Tran. Ind. Appl. 33(4): 973-982 (1997).
- [8] Krykowski K., Bodora A., *Properties of the Electronic Commutator Designed for Two Zone Operation of PM BLDC Motor Drive*. Proc. of the IEEE International Symposium on Industrial Electronics ISIE, pp. 177-182 (2005).
- [9] Krykowski K., Bodora A., *Efficiency and power losses in PM BLDC motor with variable bridge/half-bridge structure electronic commutator*. Proc. of the Power Electronics and Motion Control Conference PEMC, pp. 326-330 (2008).
- [10] Bodora A., Biskup T., Domoracki A., Kołodziej H., *BLDC motors drive of EV with microprocesor control system*. Wiadomości Elektrotechniczne 75(10): 50-55 (2007) (in Polish).
- [11] Texas Instruments, *TMS320F2810, TMS320F2811, TMS320F2812, TMS320C2810, TMS320C2811, TMS320C2812 Digital Signal Processors Data Manual*. (2004).
- [12] International Rectifier, *IR2130/IR2132 3-Phase Bridge Driver Data Sheet*. No. PD60019 Rev. P.
- [13] Biskup T., Bodora A., Domoracki A., *Control method of two-zone electronic commutator switches with bootstrap driver*. Patent application no P.391609, Polish Patent Office (2010) (in Polish).