

Study of delta/polygon-connected transformer-based 36-pulse ac-dc converter for power quality improvement

ROHOLLAH ABDOLLAHI

Qom Branch, Islamic Azad University, Qom, Iran

e-mail: Rohollah.abdollahi@yahoo.com

(Received: 17.10.2011, revised: 16.03.2012)

Abstract: Design of a delta/polygon-connected autotransformer based 36-pulse ac-dc converter is presented in this paper. The 36-pulse topology is obtained via two paralleled eighteen-pulse ac-dc converters each of them consisting of a nine-phase (nine-leg) diode bridge rectifier. For independent operation of paralleled diode-bridge rectifiers, two inter-phase transformers (IPT) is designed and implemented. A transformer is designed to supply the rectifier. The design procedure of magnetics is in a way such that makes it suitable for retrofit applications where a six-pulse diode bridge rectifier is being utilized. The proposed structure has been implemented and simulated using Matlab/Simulink software under different load conditions. Simulation results confirmed the significant improvement of the power quality indices (consistent with the IEEE-519 standard requirements) at the point of common coupling. Furthermore, near unity power factor is obtained for a wide range of DTCIMD operation. A comparison is made between 6-pulse and proposed converters from view point of power quality indices. Results show that input current total harmonic distortion (THD) is less than 4% for the proposed topology at variable loads.

Key words: AC-DC converter, delta/polygon transformer, power quality, 36-pulse rectifier, direct torque controlled induction motor drive (DTCIMD).

1. Introduction

Recent advances in solid state conversion technology has led to the proliferation of variable frequency induction motor drives (VFIMD's) that are used in several applications such as air conditioning, blowers, fans, pumps for waste water treatment plants, textile mills, rolling mills etc [1]. As a practical technique, direct torque control (DTC) strategy is implemented in induction motor drives (DTCIMDs), serving various applications. These drives utilize voltage source inverters which are fed from conventional six-pulse diode bridge rectifiers. The most important drawback of these rectifiers is their poor power quality injection of harmonic currents into ac mains. The circulation of current harmonics into the source impedance yields in harmonically polluted voltages at the point of common coupling (PCC) and

consequently resulting in undesired supply voltage conditions for the nearby costumers [1]. The value of current harmonic components which are injected into the grid by nonlinear loads should be controlled within the standard limits. The most prominent standards in this field are IEEE standard 519 [2] and the International Electro-technical Commission (IEC) standard [3]. For DTCIMDs one effective solution to eliminate harmonics is the use of multipulse AC-DC converters. According to the recent investigations, these converters are based on either phase multiplication, phase shifting, pulse doubling or a combined solution [4]-[21]. Although, in the conditions of light load or small source impedance, line current total harmonic distortion (THD) will be more than 5% for up to 18-pulse AC-DC converters.

A Polygon-Connected Autotransformer-Based 24-pulse AC-DC converter is reported in [17] which has THD variation of 4.48% to 5.65% from full-load to light-load (20% of full-load). Another T-Connected Autotransformer-Based 24-Pulse AC-DC Converter has also been presented in [18], however, the THD of the supply current with this topology is reported to vary from 2.46% to 5.20% which is more than 5% when operating at light load.

The 36-pulse one was designed for vector controlled induction motor drives in [21] which has THD variation of 2.03% to 3.74% from full-load to light-load (20% of full-load) respectively but the dc link voltage is higher than that of a 6-pulse diode bridge rectifier, thus making the scheme nonapplicable for retrofit applications.

In this paper, a 36-pulse ac-dc converter is proposed employing a novel delta/polygon transformer. The proposed design method will be suitable even when the transformer output voltages vary while keeping its 36-pulse operation. In the proposed structure, two nine-leg diode-bridge rectifiers are paralleled via two interphase transformers (IPTs) and fed from a transformer. Hence, a 36-pulse output voltage is obtained. Detailed design tips of the IPT and totally the whole structure of 36-pulse ac-dc converter are described in this paper and the proposed converter is modeled and simulated in MATLAB to study its behavior and specifically to analyze the power quality indices at ac mains.

Furthermore, a 36-pulse ac-dc converter consisting of a delta/polygon transformer, two eighteen-pulse diode bridge rectifiers paralleled through two IPTs, and with a DTCIMD load Figure 1. Simulation results of six-pulse and proposed 36-pulse ac-dc converters feeding a DTCIMD load are scheduled and various quality criteria such as THD of ac mains current, power factor, displacement factor, distortion factor, and THD of the supply voltage at PCC are compared.

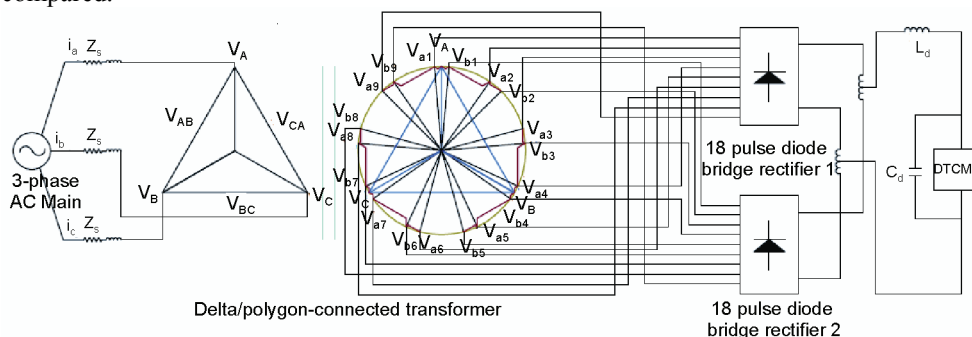

Fig. 1. Delta/polygon-transformer configuration for 36-pulse ac-dc conversion

2. Proposed 20-pulse ac-dc converter

In order to implement a 36-pulse ac-dc converter through paralleling two bridge rectifiers, i.e. two 18-pulse rectifiers, two sets of nine-phase voltages with a phase difference of 40 degrees between the voltages of each group and 10 degrees between the same voltages of the two groups are required.

Accordingly, each bridge rectifier consists of nine common-anode and nine common-cathode diodes (two nine-leg rectifiers). Phasor diagram of delta/polygon transformer is shown in Fig. 2. The polygon transformer winding arrangement for 36-pulse AC-DC conversion is shown in Fig. 3 and its connection along with phasor diagram.

2.1. Design of proposed transformer for 36-pulse ac-dc converter

The aforementioned two voltage sets are called as ($V_{a1}, V_{a2}, V_{a3}, V_{a4}, V_{a5}, V_{a6}, V_{a7}, V_{a8}, V_{a9}$) and ($V_{b1}, V_{b2}, V_{b3}, V_{b4}, V_{b5}, V_{b6}, V_{b7}, V_{b8}, V_{b9}$) that are fed to rectifiers I and II, respectively. The same voltages of the two groups, i.e. V_{ai} and V_{bi} , are phase displaced of 10 degrees.

V_{a1} and V_{b1} has a phase shift of +5 and -5 degrees from the input voltage of phase A, respectively. According to phasor diagram, the nine-phase voltages are made from ac main phase and line voltages with fractions of the primary winding turns which are expressed with the following relationships. Consider three-phase voltages of primary windings as follows:

$$V_A = V_s \angle 0^\circ, V_B = V_s \angle -120^\circ, V_C = V_s \angle 120^\circ \quad (1)$$

Where, nine-phase voltages are:

$$\begin{aligned} V_{a1} &= V_s \angle +5^\circ, V_{a2} = V_s \angle -35^\circ, V_{a3} = V_s \angle -75^\circ, \\ V_{a4} &= V_s \angle -115^\circ, V_{a5} = V_s \angle -155^\circ, V_{a6} = V_s \angle -195^\circ, \\ V_{a7} &= V_s \angle -235^\circ, V_{a8} = V_s \angle -275^\circ, V_{a9} = V_s \angle -315^\circ. \end{aligned} \quad (2)$$

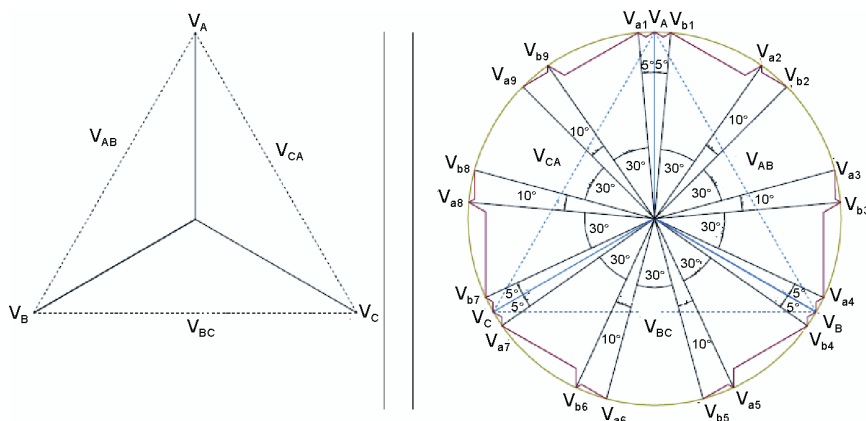

Fig. 2. Phasor representation of transformer for 36-pulse ac-dc converter having Hexagon connected secondary winding

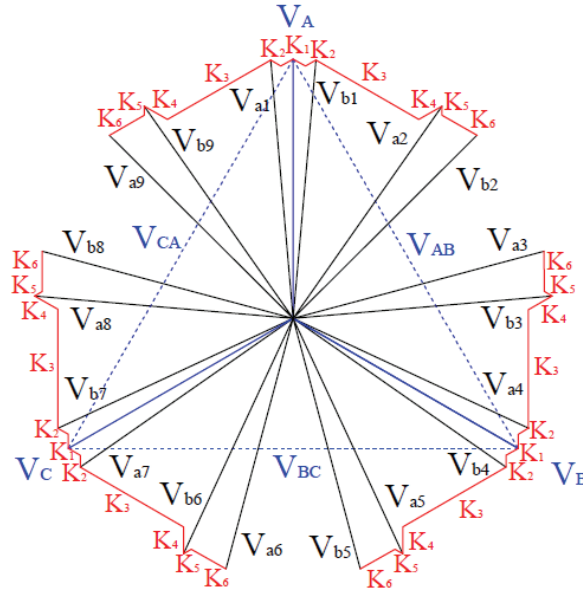

Fig. 3. Winding arrangement of transformer for 36-pulse ac-dc converter having hexagon connected secondary winding

$$\begin{aligned}
 V_{b1} &= V_s \angle -5^\circ, V_{b2} = V_s \angle -45^\circ, V_{b3} = V_s \angle -85^\circ, \\
 V_{b4} &= V_s \angle -125^\circ, V_{b5} = V_s \angle -165^\circ, V_{b6} = V_s \angle -205^\circ, \\
 V_{b7} &= V_s \angle -245^\circ, V_{b8} = V_s \angle -285^\circ, V_{b9} = V_s \angle -325^\circ
 \end{aligned} \tag{3}$$

Input voltages for converter I are:

$$\begin{aligned}
 V_{b1} &= V_A + K_1 V_B - K_2 V_C \\
 V_{b2} &= V_{a2} - K_5 V_A + K_6 V_B \\
 V_{b3} &= V_{a4} + K_3 V_A - K_4 V_C \\
 V_{b4} &= V_B + K_1 V_C - K_2 V_A \\
 V_{b5} &= V_{a5} - K_5 V_B + K_6 V_C \\
 V_{b6} &= V_{a7} + K_3 V_B - K_4 V_A \\
 V_{b7} &= V_C + K_1 V_A - K_2 V_B \\
 V_{b8} &= V_{a8} - K_5 V_C + K_6 V_A
 \end{aligned} \tag{4}$$

Input voltages for converter II are:

$$\begin{aligned}
 V_{b1} &= V_A + K_1 V_B - K_2 V_C \\
 V_{b2} &= V_{a2} - K_5 V_A + K_6 V_B \\
 V_{b3} &= V_{a4} + K_3 V_A - K_4 V_C \\
 V_{b4} &= V_B + K_1 V_C - K_2 V_A \\
 V_{b5} &= V_{a5} - K_5 V_B + K_6 V_C \\
 V_{b6} &= V_{a7} + K_3 V_B - K_4 V_A \\
 V_{b7} &= V_C + K_1 V_A - K_2 V_B \\
 V_{b8} &= V_{a8} - K_5 V_C + K_6 V_A
 \end{aligned}
 \tag{5}$$

$$V_{AB} = \sqrt{3}V_A \angle 30^\circ, V_{BC} = \sqrt{3}V_B \angle 30^\circ, V_{CA} = \sqrt{3}V_C \angle 30^\circ.
 \tag{6}$$

Constants K_1 - K_6 are calculated using (2)-(6) to obtain the required windings turn numbers to have the desired phase shift for the two voltage sets:

$$\begin{aligned}
 K_1 &= 0.05412, K_2 = 0.04652, K_3 = 0.45788, \\
 K_4 &= 0.1038, K_5 = 0.034955, K_6 = 0.15419.
 \end{aligned}
 \tag{7}$$

2.2. Design of transformer for retrofit applications

The value of output voltage in multipulse rectifiers boosts relative to the output voltage of a six-pulse converter making the multipulse rectifier inappropriate for retrofit applications. For instance, with the transformer arrangement of the proposed 36-pulse converter, the rectified output voltage is 20% higher than that of six-pulse rectifier.

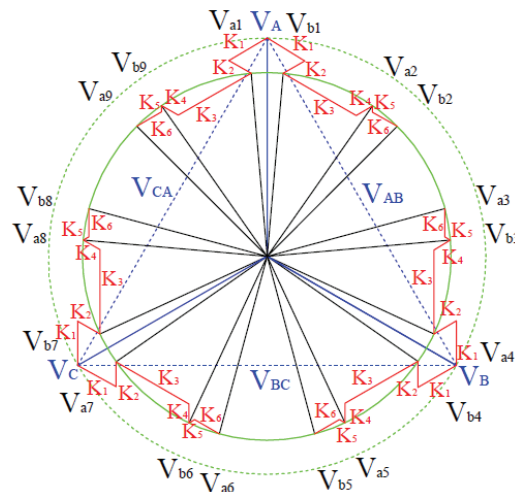

Fig.4. Phasor diagram of voltages in the proposed transformer connection alongwith modifications for retrofit arrangement

For retrofit applications, the above design procedure is modified so that the dc-link voltage becomes equal to that of six-pulse rectifier. This will be accomplished via modifications in the tapping positions on the windings as shown in Fig. 4. It should be noted that with this approach, the desired phase shift is still unchanged. Similar to section II part 1, the following equations can be derived as:

$$|V_S| = 0.8314|V_A| \quad (8)$$

Input voltages for converter I are:

$$\begin{aligned} V_{a1} &= V_A + K_1 V_C + K_2 V_B \\ V_{a2} &= V_{b1} - K_3 V_B - K_4 V_C \\ V_{a3} &= V_{b3} - K_5 V_B + K_6 V_A \\ V_{a4} &= V_B + K_1 V_A + K_2 V_C \\ V_{a5} &= V_{b4} - K_3 V_C - K_4 V_A \\ V_{a6} &= V_{b6} - K_5 V_C + K_6 V_B \\ V_{a7} &= V_C + K_1 V_B + K_2 V_A \\ V_{a8} &= V_{b7} + K_3 V_A - K_4 V_B \end{aligned} \quad (9)$$

Input voltages for converter II are:

$$\begin{aligned} V_{b1} &= V_A + K_1 V_B + K_2 V_C \\ V_{b2} &= V_{a2} - K_5 V_A + K_6 V_B \\ V_{b3} &= V_{a4} + K_3 V_A - K_4 V_C \\ V_{b4} &= V_B + K_1 V_C + K_2 V_A \\ V_{b5} &= V_{a5} - K_5 V_B + K_6 V_C \\ V_{b6} &= V_{a7} + K_3 V_B - K_4 V_A \\ V_{b7} &= V_C + K_1 V_A + K_2 V_B \\ V_{b8} &= V_{a8} - K_5 V_C + K_6 V_A \end{aligned} \quad (10)$$

Accordingly, the values of constants K_1 - K_6 are changed for retrofit applications as:

$$\begin{aligned} K_1 &= 0.2136, \quad K_2 = 0.12994, \quad K_3 = 0.38068, \\ K_4 &= 0.0863, \quad K_5 = 0.02907, \quad K_6 = 0.12818. \end{aligned} \quad (11)$$

The values of K_1 - K_6 establish the essential turn numbers of the transformer windings to have the required output voltages and phase shifts.

To ensure the independent operation of the rectifier groups, interphase transformers (IPTs), which are relatively small in size, are connected at the output of the rectifier bridges. With this arrangement, the rectifier diodes conduct for 120 per cycle. The kilovoltampere rating of the transformer is calculated as [4]:

$$\text{kVA} = 0.5 \sum V_{\text{winding}} I_{\text{winding}} \quad (12)$$

Where, V_{winding} is the voltage across each transformer winding and I_{winding} indicates the full load current of the winding. The apparent power rating of the interphase transformer is also calculated in a same way.

3. Matlab-based simulation

Figure 5 shows the implemented ac-dc converter with DTCIMD in MATLAB software using SIMULINK and power system block set (PSB) toolboxes. In this model, a three-phase 460 V and 60 Hz network is utilized as the supply for the 36-pulse converter. The designed transformer is modeled via three multi-winding transformers. Multi-winding transformer block is also used to model IPT.

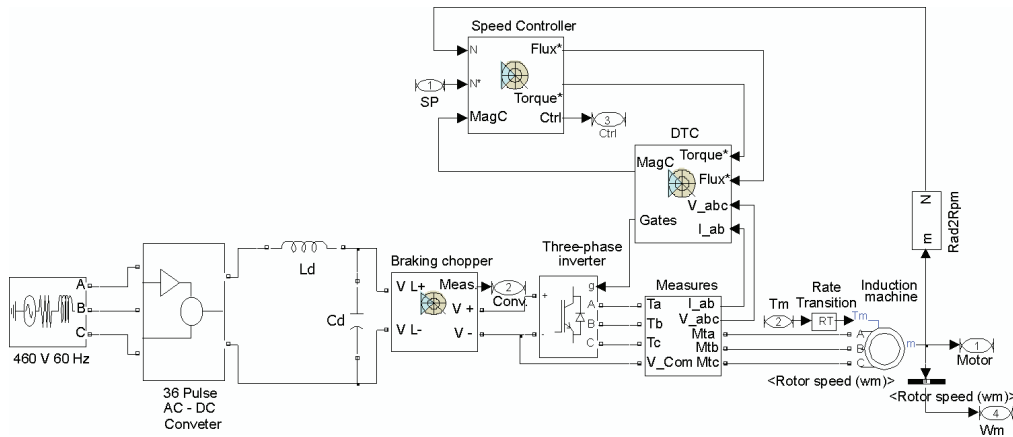

Fig. 5. Matlab model of 36-pulse ac-dc converter fed DTCIMD

At the converter output, a series inductance (L) and a parallel capacitor (C) as the dc link are connected to IGBT-based Voltage Source Inverter (VSI). VSI drives a squirrel cage induction motor employing direct torque control strategy. The simulated motor is 50 hp (37.3 kW), 4-pole, and Y-connected. Detailed data of motor are listed in Appendix. Simulation results are depicted in Figures. 6-18. Power quality parameters are also listed in Table 1 for 6-pulse and 36-pulse ac-dc converters.

4. Results and discussion

Table 1 lists the power quality indices obtained from the simulation results of the 6-pulse and 36-pulse converters. Matlab block diagram of 36-pulse ac-dc converter system simulation, as shown in Figs. 6-7 depicts two groups of nine-phase voltage waveforms with a phase shift of 10 degrees between the same voltages of each group. Output voltage waveforms of the two parallel 18-pulse rectifiers with a phase difference of 10 degrees are shown in Fig. 8. The voltage across the interphase transformer (shown in Fig. 9) has a frequency equal to 9 times that of the supply which results in a significant reduction in volume and cost of magnetics.

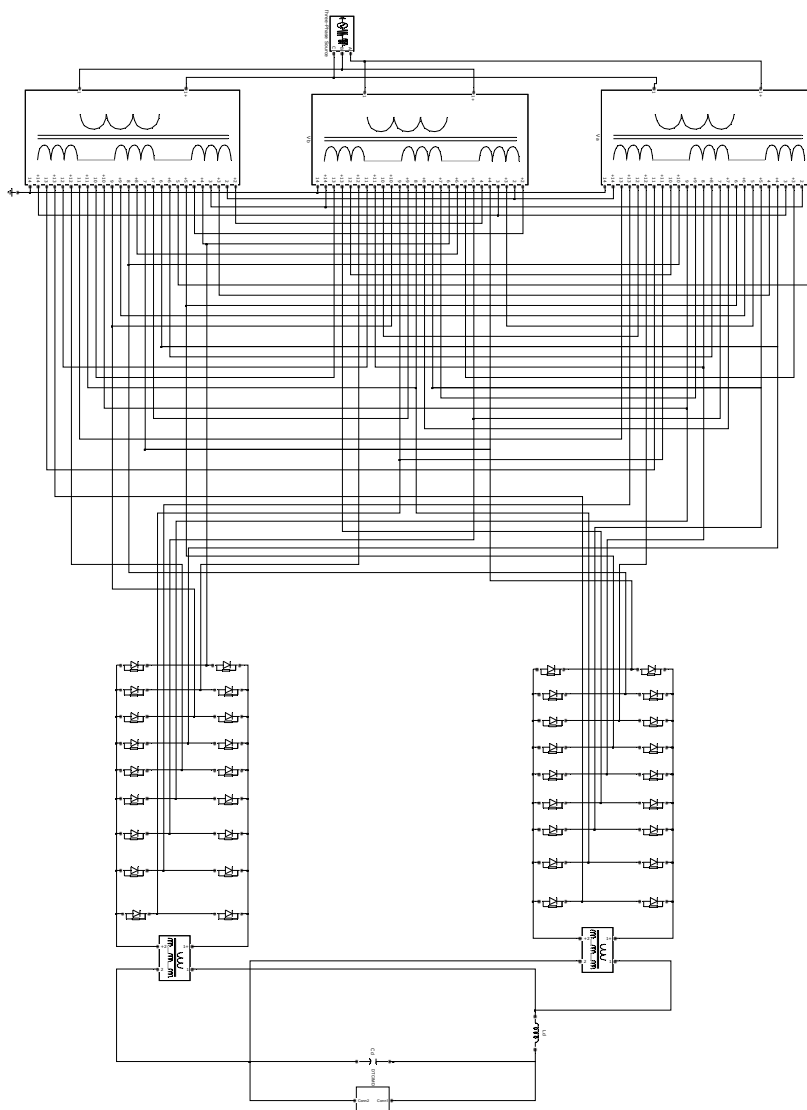

Fig. 6. Matlab block diagram of 36-pulse ac-dc converter system simulation

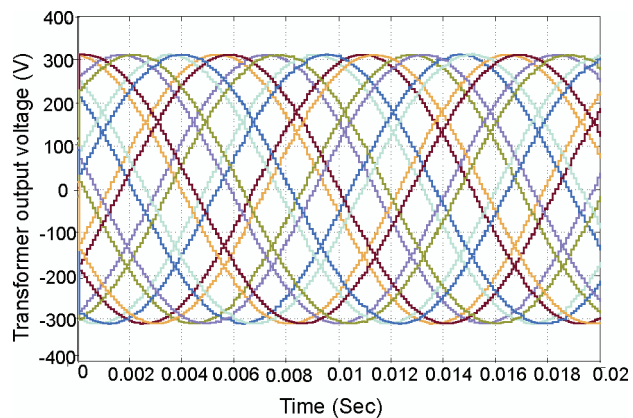

Fig. 7. Transformer output voltage



Fig. 8. Output voltage waveforms of the two parallel 18-pulse rectifiers

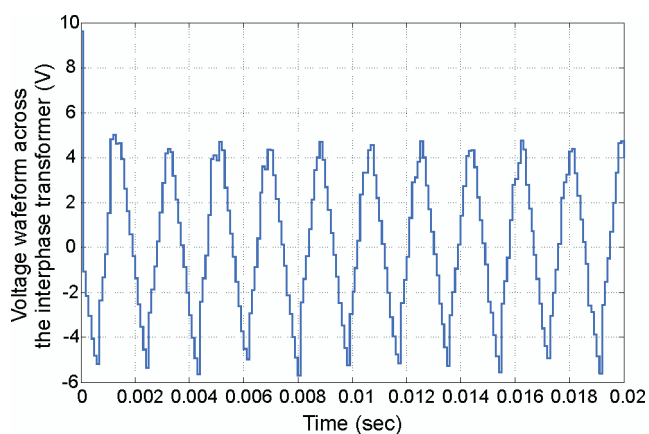

Fig. 9. Voltage waveform across the IPT

The 36-pulse converter output voltage (shown in Fig. 10) is almost smooth and free of ripples and its average value is 608.1 volts which is approximately equal to the DC link voltage of a six-pulse rectifier (607.6 volts). This makes the 36-pulse converter suitable for retrofit applications.

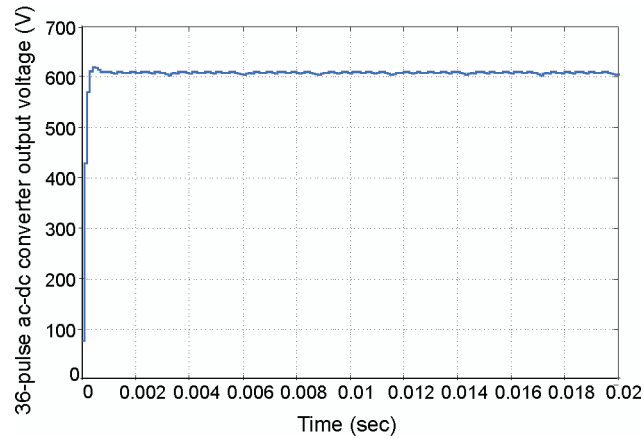

Fig. 10. 36-pulse ac-dc converter output voltage

Different output and input characteristics of the proposed 36-pulse converter feeding DTCIMD such as supply current, rotor speed, electromagnetic torque, and DC link voltage are shown in Fig. 11.

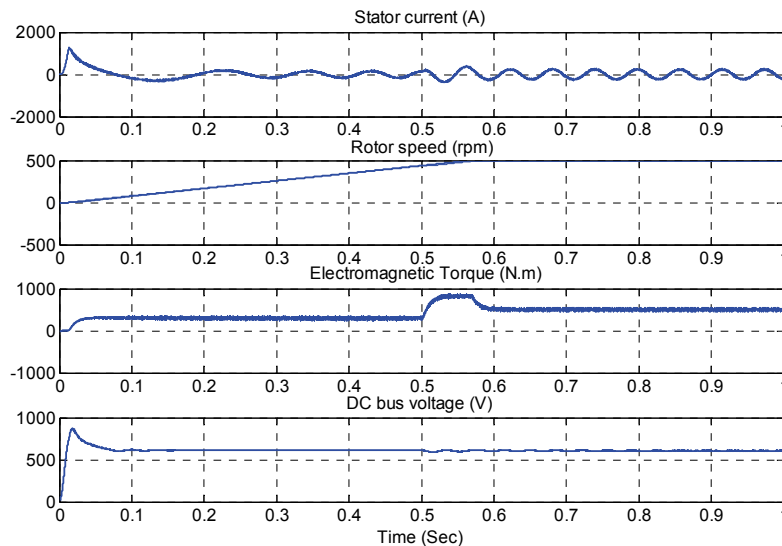

Fig. 11. Waveforms depicting dynamic response of 36-pulse diode rectifier fed DTCIMD with load perturbation (source current i_{sA} , speed N_r , developed electromagnetic torque T_e , and dc-link voltage V_{dc})

These waveforms can be compared with their equivalent parameters of a six-pulse fed DTCIMD that are shown in Fig. 12. The dynamic characteristics of the two converters can be used to compare their dynamic response through conditions such as starting or load variations.

Input current waveforms and its harmonic spectrum of the 6-pulse and 36-pulse converters extracted and shown in Figures 13-16, respectively to check their consistency with the limitations of the IEEE standard 519.

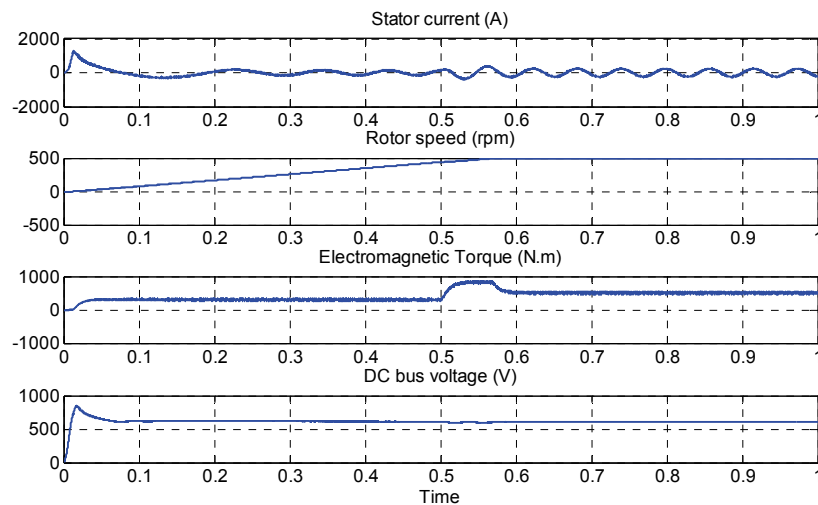

Fig. 12. Waveforms depicting dynamic response of six-pulse diode rectifier fed DTCIMD with load perturbation

Table 1. Comparison of simulated power quality parameters of the VCIMD fed from different ac-dc converters

Sr. No.	Topology	% THD of V_{ac}	AC mains current I_{SA} (A)		% THD of I_{SA} at		Distortion factor, DF		Displacement factor, DPF		Power factor, PF	
			light load	full load	light load	full load	light load	full load	light load	full load	light load	full load
1	6-pulse	5.64	10.33	52.69	52.53	28.53	0.8850	0.9599	0.9858	0.9881	0.8730	0.9485
2	36-pulse	2.93	10.57	52.52	3.89	2.92	0.9992	0.9993	0.9994	0.9986	0.9986	0.9979

These harmonic spectrums are obtained when induction motor operates under light load (20% of full load) and full load conditions. Obviously, for 6-pulse converter, fifth and seventh order harmonics are dominant. Hence, input current THD of this converter will be relatively a large amount and is equal to 28.53% and 52.53% for full load and light load conditions that are not within the standard margins.

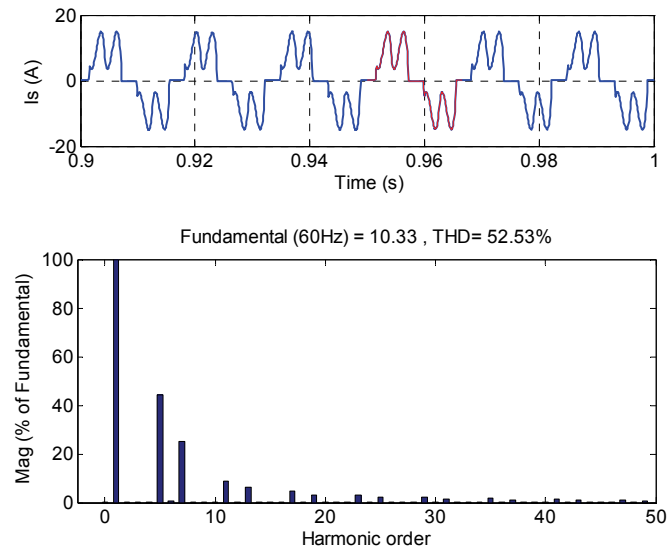

Fig. 13. Input current waveform of six-pulse ac-dc converter at light load and its harmonic spectrum

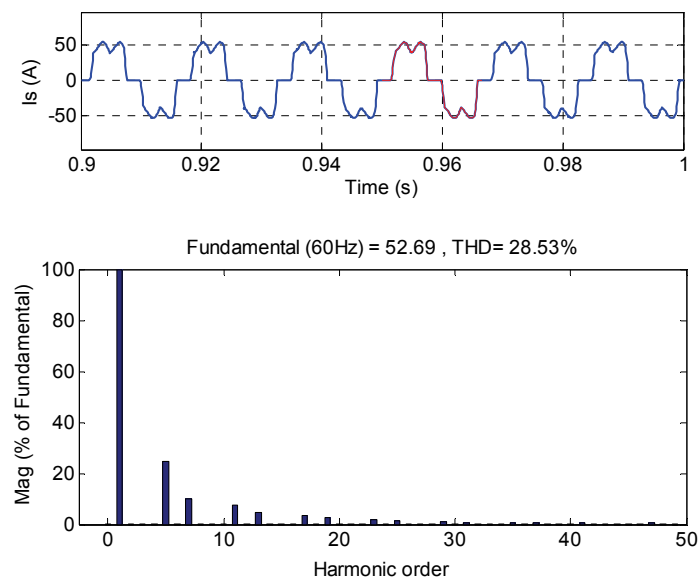

Fig. 14. Input current waveform of six-pulse ac-dc converter at full load and its harmonic spectrum

On the other hand, as shown in Figs. 15-16, 36-pulse converter has an acceptable current THD (3.89% for light load and 2.92% for full load conditions). In this configuration, low order harmonics up to 33rd are eliminated in the supply current.

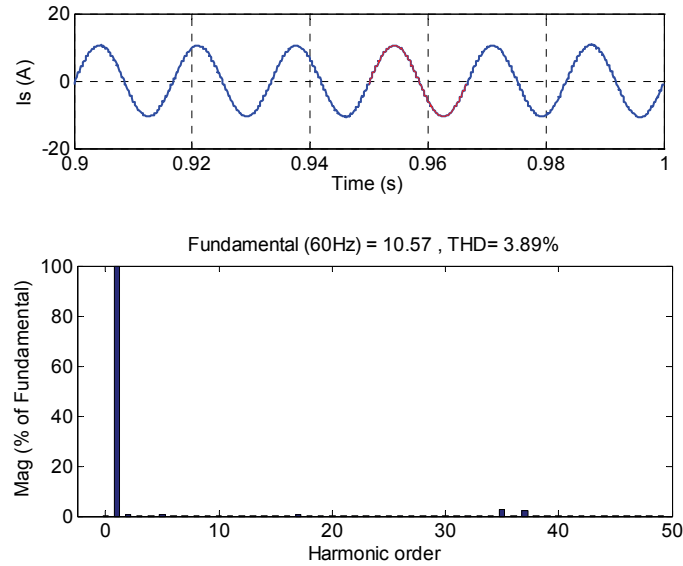

Fig. 15. Input current waveform of 36-pulse ac-dc converter at light load and its harmonic spectrum

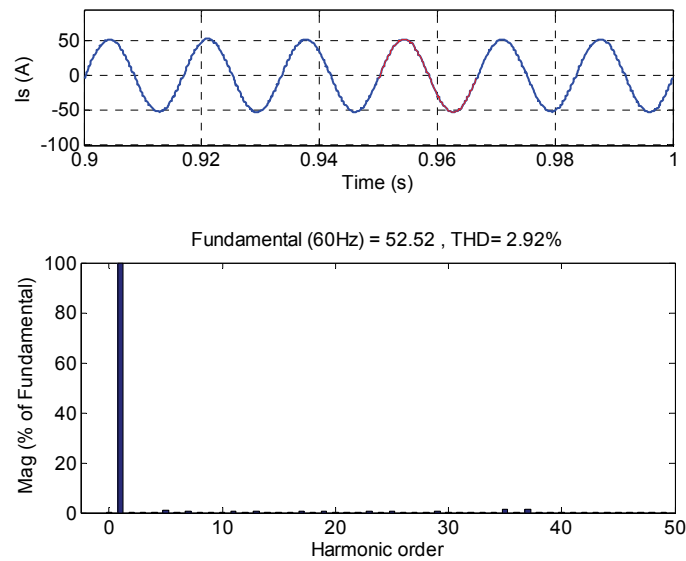

Fig. 16. Input current waveform of 36-pulse ac-dc converter at full load and its harmonic spectrum

In general, the largely improved performance of the 36-pulse converter makes the power quality indices such as THD of supply current and voltage (THDi and THDv), displacement power factor (DPF), distortion factor (DF), and power factor (PF) satisfactory for different loading conditions. The aforementioned criteria are listed in Table 1 for the three types of converters.

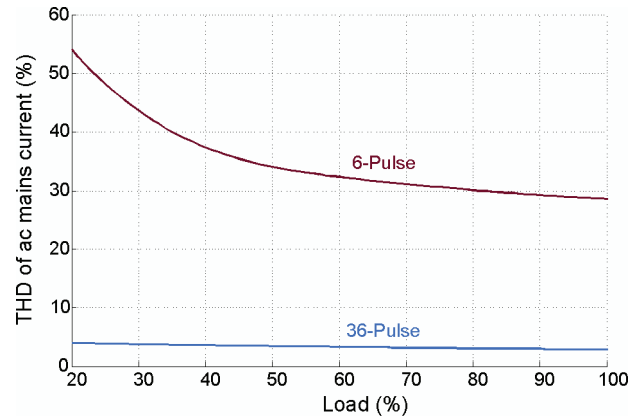

Fig. 17. Variation of THD with load on DTCIMD in 6-pulse and 36-pulse ac-dc converter

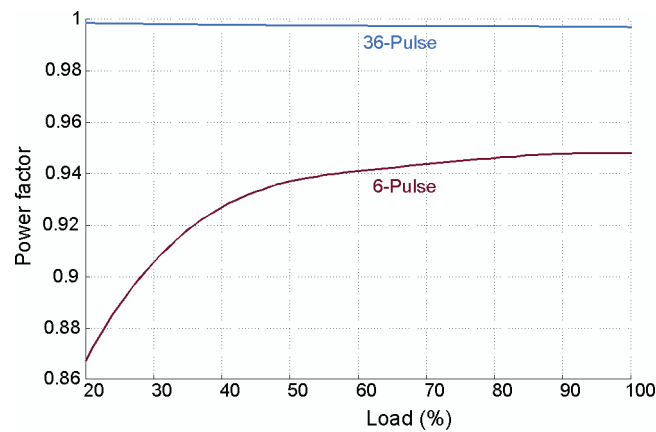

Fig. 18. Variation of power factor with load on DTCIMD in 6-pulse and 36-pulse ac-dc converter

Input current THD and power factor variations are also shown in Figures 17 and 18 respectively, for 6-pulse, and 36-pulse ac-dc converters. Results show that the input current corresponding to the proposed configuration has an almost unity power factor. Furthermore, in the worst case (light loads) the current THD has reached below 4% for the proposed topology. Different power quality indices of the proposed topology under different loading conditions are shown in Table 2. Results show that even under load variations, the 36-pulse converter has an improved performance and the current THD is always less than 4% for all loading conditions.

5. Conclusion

A novel delta/polygon-connected transformer was designed and modeled to make a 36-pulse ac-dc converter with DTCIMD load. The proposed converter output voltage is accomplished

Table 2. Comparison of power quality indices of proposed 36-pulse ac-dc converter

Load (%)	THD (%)		CF of I_s	DF	DPF	TPF	RF (%)	V_{dc} (V)
	I_s	V_s						
20	3.95	1.05	1.413	0.9992	0.9994	0.9986	0.002	611.7
40	3.56	1.58	1.413	0.9993	0.9991	0.9983	0.003	610.8
60	3.29	2.00	1.413	0.9993	0.9990	0.9983	0.004	610.0
80	3.06	2.44	1.414	0.9993	0.9988	0.9981	0.003	609.0
100	2.93	2.68	1.414	0.9993	0.9986	0.9979	0.005	608.1

via two paralleled eighteen-pulse ac-dc converters each of them consisting of nine-phase diode bridge rectifier. Afterwards, the proposed design procedure was modified for retrofit applications. Simulation results prove that, for the proposed topology, input current distortion factor is in a good agreement with IEEE 519 requirements. Current THD is less than 4% for varying loads. It was also observed that the input power factor is close to unity resulting in reduced input current for DTCIMD load. Thus, the proposed 36-pulse ac-dc converter can easily replace the existing 6-pulse converter without much alteration in the existing system layout and equipment.

Appendix

Motor and Controller Specifications

Three-phase squirrel cage induction motor—50 hp (37.3 kW), three phase, four pole, Y-connected, 460 V, 60 Hz. $R_s = 0.0148 \Omega$; $R_r = 0.0092 \Omega$; $X_{ls} = 1.14 \Omega$; $X_{lr} = 1.14 \Omega$, $X_{Lm} = 3.94 \Omega$, $J = 3.1 \text{ Kg} \cdot \text{m}^2$.

Controller parameters: PI controller $K_p = 300$; $K_i = 2000$. DC link parameters: $L_d = 2 \text{ mH}$; $C_d = 3200 \mu\text{F}$. Source impedance: $Z_s = j0.1884 \Omega$ (=3%).

References

- [1] Bose B.K., *Modern Power Electronics and AC Drives*. Singapore: Pearson Education (1998).
- [2] IEEE Standard 519-1992, IEEE Recommended Practices and Requirements for Harmonic Control in Electrical Power Systems. New York, IEEE Inc. (1992).
- [3] IEC Standard 61000-3-2:2004, Limits for harmonic current emissions, International Electromechanical Commission, Geneva (2004).
- [4] Paice D.A., *Power Electronic Converter Harmonics: Multipulse Methods for Clean Power*. New York, IEEE Press (1996).
- [5] Hammond R., Johnson L., Shimp A., Harder D., *Magnetic solutions to line current harmonic reduction*. Proc. Conf. Power Con., pp. 354-364 (1994).

- [6] Johnson L.J., Hammond R.E., *Main and auxiliary transformer rectifier system for minimizing line harmonics*. U.S. Patent 5 063 487, Nov. (1991).
- [7] Singh B., Gairola S., Chandra A., Haddad K., *Multipulse AC-DC Converters for Improving Power Quality: A Review*. IEEE Transactions on Power Electronics 23(1), January (2008).
- [8] Singh B., Bhuvaneswari G., Garg V., *Harmonic mitigation using 12-pulse ac-dc converter in vector-controlled induction motor drives*. IEEE Trans. Power Delivery 21(3): 1483–1492, Jul. (2006).
- [9] Chivite-Zabalza F.J., Forsyth A.J., Trainer D.R., *Analysis and practical evaluation of an 18-pulse rectifier for aerospace applications*. Proc. 2nd Int. Conf. Power Electron. Mach. Drives (PEMD) 1: 338-343 (2004).
- [10] Kamath G.R., Benson D., Wood R., *A novel autotransformer based 18-pulse rectifier circuit*. Proc. 2001 IEEE IECON, Conf., pp. 795-801 (2002).
- [11] Singh B., Bhuvaneswari G., Garg V., *Harmonic Mitigation in AC-DC Converters for Vector Controlled Induction Motor Drives*. IEEE Transactions on Energy Conversion 22(3): 637-646, Sept. (2007).
- [12] Singh B., Bhuvaneswari G., Garg V., *A Novel Polygon Based 18-Pulse AC-DC Converter for Vector Controlled Induction Motor Drives*. IEEE Transactions on Power Electronics 22(2), March (2007).
- [13] Singh B., Garg V., Bhuvaneswari G., *A Novel T-Connected Autotransformer-Based 18-Pulse AC-DC Converter for Harmonic Mitigation in Adjustable-Speed Induction-Motor Drives*. IEEE Transactions on Industrial Electronics 54(5), October (2007).
- [14] Singh B., Bhuvaneswari G., Garg V., *Eighteen-Pulse AC-DC Converter for Harmonic Mitigation in Vector Controlled Induction Motor Drives*. Proc. Int. Conf. on Power Electronics and Drives systems, 28 Oct.-01 Nov., 2: 1514-1519 (2005).
- [15] Sefa I., Altin N., *A novel approach to determine the interphase transformer inductance of 18 pulse rectifiers*. Energy Conversion and Management 50, Issue 10: 2495-2503, October (2009).
- [16] Hammond R., Johnson L., Shimp A., Harder D., *Magnetic solutions to line current harmonic reduction*. Proc. Conf. Power Con., pp. 354-364 (1994).
- [17] Singh B., Garg V., Bhuvaneswari G., *Polygon-Connected Autotransformer-Based 24-Pulse AC-DC Converter for Vector-Controlled Induction-Motor Drives*. IEEE Transactions on Industrial Electronics 55(1): 197-208, January (2008).
- [18] Singh B., Bhuvaneswari G., Garg V., *T-Connected Autotransformer-Based 24-Pulse AC-DC Converter for Variable Frequency Induction Motor Drives*. IEEE Transactions on Energy Conversion 21(3): 663-672, Sept. (2006).
- [19] Singh B., Bhuvaneswari G., Garg V., Gairola S., *Pulse multiplication in ac-dc converters for harmonic mitigation in vector controlled induction motor drives*. IEEE Trans. Energy Conv. 21(2): 342-352, Jun. (2006).
- [20] Singh B., Bhuvaneswari G., Garg V., *Power-quality improvements in vector-controlled induction motor drive employing pulse multiplication in ac-dc converters*. IEEE Trans. on Power Delivery, 21(3): 1578-1586, Jul. (2006).
- [21] Singh B., Gairola S., *Design and Development of a 36-Pulse AC-DC Converter for Vector Controlled Induction Motor Drive*. Proc. IEEE Conf. Power Electron. Drives Syst. PEDS'07, pp. 694-701 (2007).