

# Application of a PSO algorithm for identification of the parameters of Jiles-Atherton hysteresis model\*

LUKASZ KNYPPIŃSKI, LECH NOWAK, PIOTR SUJKA, KAZIMIERZ RADZIUK

*Institute of Electrical Engineering and Electronics, Poznan University of Technology  
Piotrowo 3a, 60-965 Poznań, Poland*

*e-mail: {Lukasz.Knypinski/Lech.Nowak}@put.poznan.pl*

(Received: 11.07.2011, revised: 04.11.2011)

**Abstract:** In the paper an algorithm and computer code for the identification of the hysteresis parameters of the Jiles-Atherton model have been presented. For the identification the particle swarm optimization method (PSO) has been applied. In the optimization procedure five design variables has been assumed. The computer code has been elaborated using Delphi environment. Three types of material have been examined. The results of optimization have been compared to experimental ones. Selected results of the calculation for different material are presented and discussed.

**Key words:** optimization, hysteresis, Jiles-Atherton model, particle swarm optimization method

## 1. Introduction

The model presented by D. Jiles and D. Atherton is a full physical model describing magnetic hysteresis [7, 8]. The application of this model makes it possible to illustrate the magnetization vector and the ferromagnetic loss of a specific magnetic material. A general problem for Jiles-Atherton model is its parameters identification. Usually, the identification is performed on the basis of measurements and consist in determining the five parameters which explicitly describe the hysteresis curve of a given material [13].

The particle swarm optimization (PSO) method is an efficient non-deterministic algorithm. The PSO method was introduced by J. Kennedy and R. Eberhart in the year 1995 [9]. Since then, the PSO algorithm has been successfully applied to solve many different problems, for examples: flowshop scheduling [22], TEAM 22 workshop problem [17], traveling salesman problem [18], optimal design in technology tasks [4, 6, 14, 15] and also identification of the parameters of Jiles-Atherton hysteresis model [13].

In the literature it is possible to find many papers concerning optimization of the hysteresis loop parameters. In these papers different approaches for optimization of parameters for the Jiles-Atherton model are applied: genetic algorithm [24], neural networks [21] and simulated annealing [3].

---

\* This is extended version of a paper which was presented at the 8th *International Conference on Computation in Electromagnetics*, Wrocław, Poland, 11-14, 04, 2011.

This paper presents the algorithm and computer code to make identification of the parameters of the Jiles-Atherton model on the basis of experimental results. The algorithm has been elaborated using PSO method. The identification is based on minimizing the objective function characterizing the difference between the Jiles-Atherton model and the measured hysteresis loop. The hysteresis loop for different magnetic material has been determined.

## 2. Jiles-Atherton hysteresis method

In the Jiles-Atherton model [2, 7, 12, 19], it is assumed that the magnetization  $M$  of a material is caused by the factors representing reversible  $M_{rev}$  and irreversible  $M_{irr}$  processes during the magnetization of the core:

$$M = M_{rev} + M_{irr}. \quad (1)$$

The irreversible process occurring in the course of magnetization is described by a following differential equation:

$$\frac{dM_{irr}}{dH} = \frac{M_{an} - M_{irr}}{k_h \delta - \alpha(M_{an} - M_{irr})}, \quad (2)$$

where  $\delta = \text{sgnd } H/dt$ ,  $M_{an}$  is a non-hysteresis curve described by:

$$M_{an} = M_{sat} \left( \coth \frac{H + \alpha M}{a} - \frac{a}{H + \alpha M} \right). \quad (3)$$

Here,  $k_h$  and  $\alpha$  are the factors depending on material parameters [8],  $a$  is the shape factor,  $M_{sat}$  is the saturation magnetization.

In the elaborated model, it is assumed that the reversible process is described by the equation:

$$M_{rev} = c(M_{an} - M_{irr}), \quad (4)$$

where  $c$  is the factor depending on the type of material.

Substituting (4) into (1), after differentiation the following expression is obtained:

$$\frac{dM}{dH} = \frac{(1-c)(M_{an} - M_{irr})}{k_h \delta - \alpha(M_{an} - M_{irr})} + c \frac{dM_{an}}{dH}. \quad (5)$$

When modeling the voltage forced magnetic field, it is necessary to calculate the field intensity on the basis of magnetic flux density. Such situation occurs in the FEM algorithms when a vector magnetic potential formulation is used. Then, instead of the derivative of  $M$  with respect to the field intensity, its derivative with respect to the magnetic flux density is determined, i.e.:

$$\frac{dM}{dB} = \frac{(1-c) \frac{dM_{an}}{dB_e} + \frac{c}{\mu_0} \frac{dM_{an}}{dH_e}}{1 + (1-c) \left( \mu_0 (1-c) \frac{dM_{irr}}{dB_e} + c \frac{dM_{an}}{dH_e} \right)}, \quad (6)$$

where  $\mu_0$  is the air permeability,  $H_e$  is the effective magnetic field intensity,  $B_e = \mu_0 H_e$ , and magnetic flux density  $B = B_e - \mu_0 \alpha M + \mu M$ .

In order to solve equations (5) and (6), i.e. to determine the magnetization  $M$ , the numerical Runge-Kutta method for solving differential equations has been used.

### 3. The particle swarm optimization method

The PSO is a part of wide category of swarm intelligence methods [5]. This method is based on the observation of the social behavior of animals such as bird flocking and fish shoal [9]. In this method, the cooperation and sharing experience with all individuals are used. The swarm consists of individuals which are called particles or agents [10]. In PSO algorithm, the particles wander through a multidimensional search space. Each particle has a position and velocity. The particles learn from their own past experience. This is because each particle remembers its best individual position  $\mathbf{p}_L^i$  in the previous time steps, i.e. the position with the optimal value of the objective function ( $i$  is the number of particle). This own experience in the PSO is named the cognitive component [10, 11]. Furthermore, in each step, the particles know the position of the leader, i.e. the position  $\mathbf{p}_G$  of the best particle in the swarm. The animals share information with all particles from the flock. The communication between animals in the group constitutes in PSO so called social component [1]. In a PSO process, each particle represents an acceptable solution to the considered problem. The block diagram of the algorithm is shown in Fig. 1.

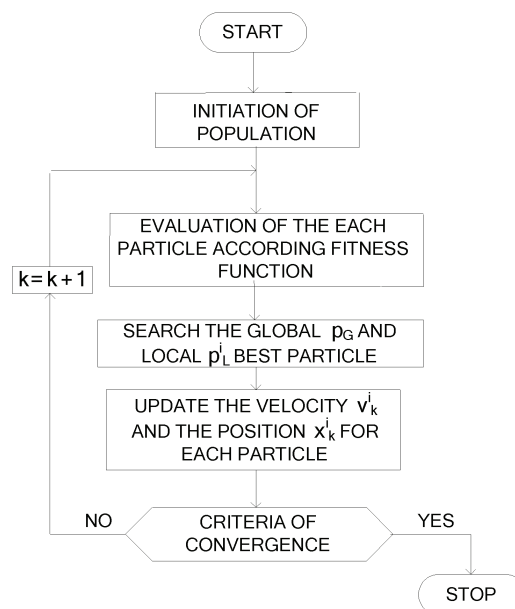

Fig. 1. The block diagram of the PSO algorithm

The first procedure of the PSO algorithm is initiation. In this procedure the vectors of positions  $\mathbf{x}_0^i$  and velocities  $\mathbf{v}_0^i$  of each particle are assumed. These vectors can be determined randomly or predetermined in  $j$ -dimensional search space [23], where  $j$  is the number of design variables. In the next step the evaluation of each particle according to the objective function (called the fitness function) is carried out. Then, the best particle position  $\mathbf{p}_G$  can be found. For each individual the objective function is compared with the objective function in the previous step. If the current value is better than the previous one then the value of  $\mathbf{p}_L^i$  is updated.

In the next stage the vectors of velocity  $\mathbf{v}_k^i$  and new position  $\mathbf{x}_k^i$  are updated. In order to calculate velocity for the  $j$ -th search direction, the following formula is used:

$$v_k^i(j) = w_1 v_{k-1}^i(j) + c_1 r_1 (p_L^i(j) - x_{k-1}^i(j)) + c_2 r_2 (p_G(j) - x_{k-1}^i(j)), \quad (7)$$

where  $k$  is the number of time step,  $w_1$  is the weight of inertia,  $v_{k-1}^i(j)$ ,  $x_{k-1}^i(j)$  are the components of velocity and position of the particle, respectively,  $c_1$ ,  $c_2$  are the learning factors [9],  $r_1$ ,  $r_2$  are the random numbers; usually  $r_1$ ,  $r_2 \in (0, 1)$ .

Finally, the particle positions are calculated:

$$x_k^i(j) = x_{k-1}^i(j) + v_k^i(j). \quad (8)$$

#### 4. The optimization procedure

The algorithm and computer code for identification of the hysteresis parameters of the Jiles-Atherton model has been elaborated. In order to optimize these parameters, the PSO algorithm has been employed. The optimization task was defined as follows: for the known hysteresis loop derived from measurement, the parameters which enable the best representation of the Jiles-Atherton model have to be found. The hysteresis loop is described by five variables  $z(j)$ ;  $j = 1, 2, \dots, 5$ :  $z(1) = M_{sat}$ ,  $z(2) = a$ ,  $z(3) = k_h$ ,  $z(4) = c$ ,  $z(5) = \alpha$  [13, 21]. These variables form design vector  $\mathbf{z} = [M_{sat} \ a \ k \ c \ \alpha]^T$ . The variables  $z(j)$  have been transformed into dimensionless quantities  $s(j)$  according to the formula [11]:

$$s(j) = \frac{(z(j) - z_{min}(j))}{(z_{max}(j) - z_{min}(j))}, \quad (9)$$

where  $z_{min}(j)$  and  $z_{max}(j)$  are the expected lower and upper limits of each variable  $z(j)$ , respectively. If  $z(j) \in \langle z_{min}(j), z_{max}(j) \rangle$  then  $s(j) \in \langle 0, 1 \rangle$ .

These variables  $s(j)$  form the dimensionless, normalized vector  $\mathbf{s}$ .

Usually the objective function is referred to the difference between measured and simulated values of magnetic field intensities for given values of magnetic flux density [13]. However such a type of objective function does not ensure the convergence to the correct solution. Therefore, in the paper, a modified objective function has been proposed. It is composed of three terms:  $g_1(\mathbf{s})$ ,  $g_2(\mathbf{s})$  and  $g_3(\mathbf{s})$ . The first term concerns the magnetic field

intensity; the second one is referred to the difference between the areas of the simulated and measured hysteresis loops. The last term concerns the maximum points (vertexes) of the loops. The **dimensionless** objective function for each particle has been defined as follows:

$$f(\mathbf{s}) = \lambda_1 g_1(\mathbf{s}) + \lambda_2 g_2(\mathbf{s}) + \lambda_3 g_3(\mathbf{s}), \quad (10)$$

where:

$$g_1(\mathbf{s}) = \frac{1}{N} \sum_{n=1}^N \left( \frac{H^{(m)}[n] - H^{(s)}[n]}{H^{(m)}[n]} \right), \quad (11)$$

$$g_2(\mathbf{s}) = \left( \frac{S^{(m)} - S^{(s)}}{S^{(m)}} \right), \quad (12)$$

$$g_3(\mathbf{s}) = \left( \frac{H_{\max}^{(m)} - H_{\min}^{(s)}}{H_{\max}^{(m)}} \right). \quad (13)$$

Here  $\mathbf{s}$  is the vector composed of five variables  $s(j)$ ,  $\lambda_1, \lambda_2, \lambda_3$  are the weighting factors,  $N$  is the number of measurement samples, superscripts  $(m)$  and  $(s)$  denote the measured and simulated values, respectively,  $H^{(m)}[n], H^{(s)}[n]$  are the values of magnetic field intensity for the  $n$ -th measured and simulated sample,  $S^{(m)}, S^{(s)}$  are the areas of measured and simulated loop areas,  $H_{\max}^{(m)}, H_{\min}^{(s)}$  are the maximum and minimum values of magnetic field intensity for the measured and simulated hysteresis loops, respectively.

## 5. The measurement of the hysteresis loop

Special equipment for measuring the hysteresis loop has been applied. The block diagram of the equipment is shown in Fig. 2. There are a ring sample, the DC power supply LPS-305, the fluxometer Lake Shore model 480 and a computer which controls the work of the equipment. The fluxometer and power supply are adapted to connect with a computer by RS 232C port.

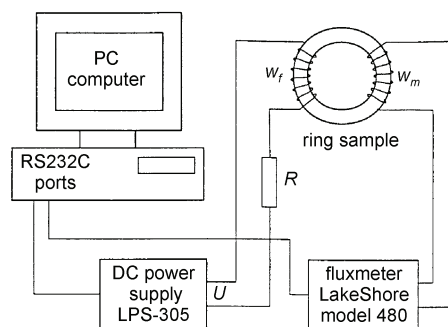

Fig. 2. The block diagram of the computer controlled experimental setup

All ring samples of materials have been examined using the computer controlled experimental setup – Fig. 3.

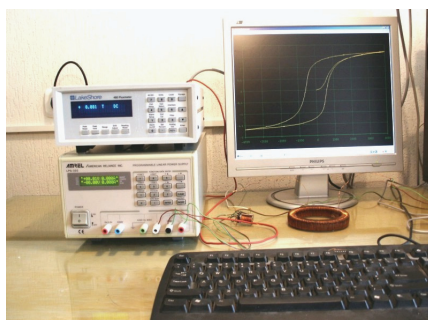

Fig. 3. The computer controlled experimental setup

## 6. Optimization results

In order to validate the elaborated algorithm and computer code, three types of material have been studied: (a) supranhyster [20], (b) ferrite K 2004 [25] and (c) St 45 steel. The hysteresis loops have been determined using the computer controlled experimental setup. Calculations on a swarm with 1500 particles have been performed. The number of time step was 100. The following parameters of the optimization procedure have been assumed:  $\lambda_1 = 0.1$ ,  $\lambda_2 = \lambda_3 = 0.45$  and the coefficients of the PSO algorithm  $w_1 = 0.5$ ,  $c_1 = 1.1$  and  $c_2 = 1.3$  [11].

In the considered problem, the convergence of the calculations strongly depends on the initiation points. In order to avoid this fact, the authors proposed an efficient algorithm comprising two main stages. In the first stage, the calculations have been repeated  $N_1$  times for different start locations of the particles in the search space. After calculations, the leader, i.e. the best particle in the swarm has been determined. In the second stage, the leader from the first stage has been put into the initial population. The rest of the particles in the initial population have been determined randomly. The calculations have been repeated  $N_2$  times. In this case the randomly located particles move towards the leader from the first stage and search area around his position.

The set of optimal parameters for supranhyster are listed in Table 1. The measured and simulated hysteresis loops for this material are presented in Figure 4.

Table 1. The optimal value of design variables for supranhyster

Variable	Simulated value
$z(1)$	2207782.07
$z(2)$	250.03
$z(3)$	10.47
$z(4)$	0.321
$z(5)$	0.000335

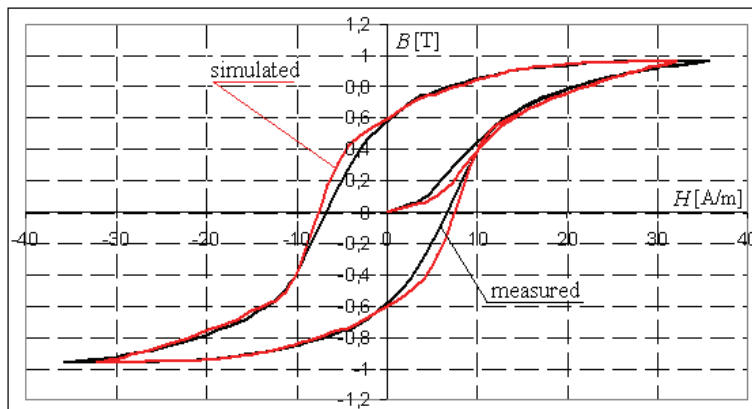

Fig. 4. Comparison of measured and simulated hysteresis loops for supranhyster

As it can be seen from Figure 4, there is a very good conformity between measured and simulated results.

Figure 5 illustrates the measured and simulated hysteresis loop for St 45 steel. The values of the design variables obtained from optimization procedure are presented in Table 2.

Table 2. The optimal value of design variables for steel St 45

Variable	Simulated value
$z(1)$	1571696.637
$z(2)$	854.221
$z(3)$	999.231
$z(4)$	0.431
$z(5)$	0.00163

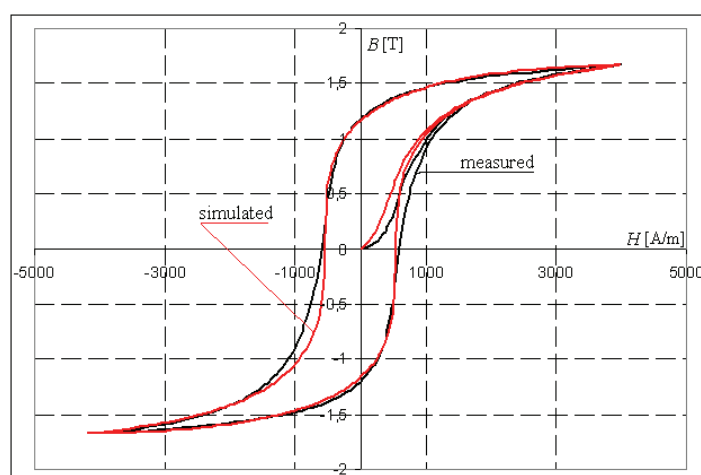

Fig. 5. Comparison of measured and simulated hysteresis loops for St 45 steel

The measured and optimized hysteresis loops for ferrite K 2004 are presented in Figure 6. The set of optimum parameters for ferrite K 2004 are shown in Table 3.

Table 3. The optimal value of design variables for K 2004

Variable	Simulated value
$z(1)$	400000.001
$z(2)$	68.779
$z(3)$	44.474
$z(4)$	0.601
$z(5)$	0.000349

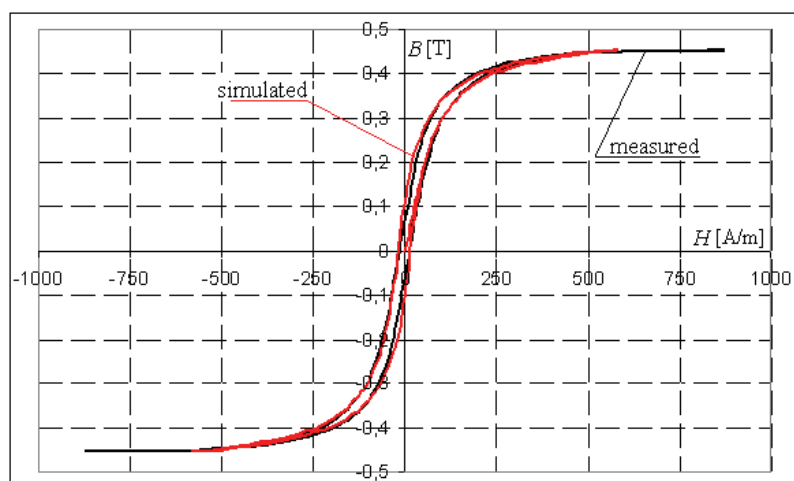

Fig. 6. Comparison of measured and simulated hysteresis loops for ferrite K 2004

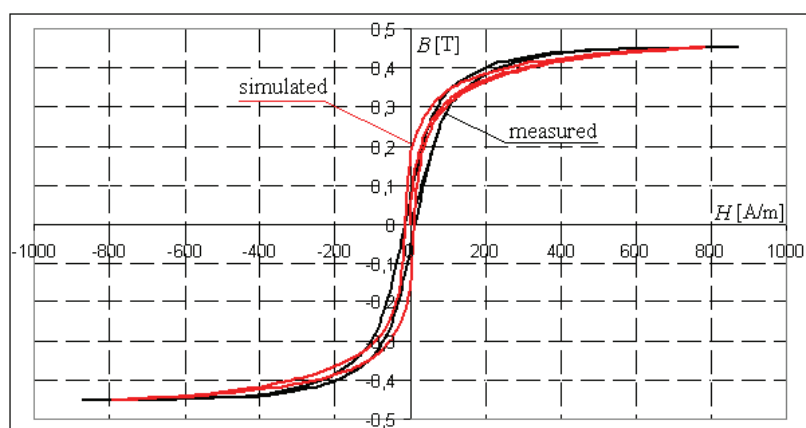

Fig. 7. Comparison of measured and simulated hysteresis loops for  $\lambda_2 = 0.95$



As it can be noticed in Fig. 6, the both hysteresis loops (measured and simulated) are similar. However, in this case, a significant difference between maximum values of magnetic field ( $H^{(m)} = 870$  A/m and  $H^{(s)} = 590$  A/m) can be observed. In order to achieve approximate maximum value of magnetic fields, the weight factor  $\lambda_2$  has been changed. In this case, the weight factor  $\lambda_2 = 0.95$  has been assumed. As a result of the calculations, the following design variables have been obtained:  $z(1) = 400010$ ,  $z(2) = 100.24$ ,  $z(3) = 285.088$ ,  $z(4) = 0.927$ ,  $z(5) = 0.000726$ . The simulated and measured hysteresis loops for  $\lambda_2 = 0.95$  are presented in Figure 7.

## 7. Conclusions

The paper presents a method for the determination of the parameters of the Jiles-Atherton model. The proposed method uses the particle swarm optimization algorithm. The authors have developed the algorithm and computer code to determine the five parameters of the Jiles-Atherton hysteresis model. The software is able to identify parameters on the basis of experimental loops. During this study, we noticed that regarding the specifics of the problem, in case of using the PSO method, to identify the hysteresis parameters it is essential to apply the modified objective function, composed of three components. The elaborated algorithm has been successfully applied for three kinds of material. Comparison between experimental and simulation results allow the validation of the good accuracy of this algorithm.

### Acknowledgements

Results presented in this work concern the research co-financed by the European Union through the European Regional Development Fund under the Operational Program Innovative Economy in the project No. POIG.01.01.02-00-113/09 – “New generation of electric drives for the mine pumps and fans”.

### References

- [1] Ali Pourmousavi S., Hashem Nehrir M., Colson C.M., Wang C., *Real-time energy management of a stand-alone hybrid wind-microturbine energy system using particle swarm optimization*. IEEE Transactions on Sustainable Energy 1(3): 193-201 (2010).
- [2] Benabou A., Clenet S., Piriou F., *Comparasion of Preisach and Jiles-Atherton models to take into account hysteresis phenomenon for finite element analysis*. Journal of Magnetism and Magnetic Materials 261: 139-160 (2003).
- [3] Boukhtache S., Azoui B., Féliachi M., *Optimized model for magnetic hysteresis in silicon-iron sheets by using the simulated annealing algorithm*. International Journal of Applied Electromagnetics and Mechanics 30(1-2): 1-7 (2009).
- [4] Dabrowski M., Rudeński A., *Efectiveness comparasion of non-evolutionary non-deterministic optimization methods in design electrical machines*. Computer Applications in Electrical Engineering, pp. 12-23 (2009).
- [5] Engelbrecht A.P., *Computational Intelligence*. John Wiley & Sons Ltd. (2007).
- [6] Hamel A., Mohellebi H., Feliachi M., Hocini F., *Particle swarm optimization for reconstruction of two-dimensional groove profiles in non destructive evaluation*. Book of Digest of the XIV Inter-

- national Symposium on Electromagnetic Fields in Mechatronics, Electrical and Electronic Engineering ISEF'2009, Arras, 10-12 September, pp. 219-220 (2009).
- [7] Jiles D., Atherton D.L., *Ferromagnetic hysteresis*. IEEE Transactions on Magnetisc 19(5): 2183-2185 (1983).
- [8] Jiles D., Thoelke J.B., Devine M.K., *Numerical determination of hysteresis parameters for the modelling of magnetic properties using theory of ferromagnetic hysteresis*. IEEE Transactions on Magnetisc 28(1): 27-35 (1992).
- [9] Kennedy J., Eberhart R., *Particle Swarm Optimization*. Proceedings of the International Conference on Neural Networks, Perth, Australia, pp. 1942-1948 (1995).
- [10] Kiranyaz S., Ince T., Yildirim A., Gabbouj M., *Fractional particle swarm optimization in multidimensional search space*. IEEE Transactions on Systems, Man and Cybernetics 40(2): 298-319 (2010).
- [11] Knypiński L., Nowak L., Radziuk K., Kowalski K., *Application of non-deterministic algorithms in the electromagnetic devices optimal design*. Computer Applications in Electrical Engineering, pp. 216-232 (2009).
- [12] Ivanyi A., *Hysteresis models in electromagnetic computation*. Akademiai Kiadó, Budapest (1997).
- [13] Marion R., Scoretti R., Raulet M.A., Krahenbühl, *Identyfication of Jiles-Atherton model parameters using particle swarm optimization*. IEEE Transactions on Magnetisc 44(6): 894-897 (2008).
- [14] Meng K., Yang Dong Z., Hui Wang D., Po Wang K., *A self-adaptive RBF neural network classifier for transformer fault analysis*. IEEE Transactions on Power Systems 25(3): 1350-1360 (2010).
- [15] Moossouni F., Brisset S., Brochet P., *Comparison of two multi-agent algorithms: ACO and PSO for the optimization of brushless DC wheel motor*. Studies in Computational Intelligence, Intelligent Computer Techniques in Applied Electromagnetics, Springer, pp. 3-10 (2008).
- [16] Rashtchi V., Bagheri A., Shabani A., Fazli S., *A novel PSO-based technique for optimal design of protective current transformer*. The International Journal for Computation and Mathematics in Electrical and Electronic Engineering 30(2), 505-518 (2011).
- [17] Santos Coelho L., Hultmann Ayala H.V., Alotto P., *A multiobjective Gaussian particle swarm approach applied to electromagnetic optimization*. IEEE Transactions on Magnetisc 46(8): 3289-3292 (2010).
- [18] Sevkli Z., Erdogan Sevilgen F., Keles Ö., *Practicle Swarm Optimization for the orienteering problem*. Proceedings of the International Symposium on Computer Information Sciences ISCIS 2006, Istanbul, 1-3 November, pp. 134-143 (2006).
- [19] Szczygłowski J., *Influence of eddy currents on magnetic hysteresis loops in soft magnetic material*. Journal of Magnetism and Magnetic Material 223: 97-102 (2001).
- [20] Sujka P., *Field-circuit algorithm of determining power losses in core taking magnetic hysteresis into account* (in polish), Prace Naukowe Instytutu Maszyn, Napędów i Pomiarów Elektrycznych Politechniki Wrocławskiej, Studia i Materiały 62(28): 343-348 (2008).
- [21] Trapanese M., *Identification of parameters of the Jiles-Atherton model by neural networks*. Journal of Applied Physics 109(7): 07D355 (2011).
- [22] Tang L., Wang X., *An improved particle swarm optimization algorithm for the hybrid flowshop scheduling to minimize total weighted completion time in process industry*. IEEE Transactions on Control Systems Technology 18(6): 1303-1314 (2010).
- [23] Vasconcelos J.A., Ramirez J.A., Takahashi R.H.C., Saldanha R.R., *Improvements in Genetic Algorithms*. IEEE Transactions on Magnetisc 37(5): 1314-3417 (2001).
- [24] Wilson D.R., Ross J.N., Brown A.D., *Optimizing the Jiles-Atherton model of hysteresis by a genetic algorithm*. IEEE Transactions on Magnetisc 37(2): 989-993 (2001).
- [25] <http://www.seen.com.pl> accessed August (2010).