

# On-line losses minimization of induction motor vector control

Z. ROUABAH<sup>1</sup>, B. ABDELHADI<sup>1</sup>, F. ANAYI<sup>2</sup>, F. ZIDANI<sup>1</sup>

<sup>1</sup>*Department of Electrical Engineering  
Batna University, Batna, Algeria*

<sup>2</sup>*Wolfson Centre of Magnetics, School of Engineering  
Cardiff University, Cardiff, UK*

*e-mail: zinebroua@ieee.org, abdelhadi3b@yahoo.com  
Anayi@cardiff.ac.uk, fatizidani@lycos.com*

(Received: 02.09.2010, revised: 08.02.2011)

**Abstract:** Conventional field-orientated Induction motor drives operate at rated flux even at low load. To improve the efficiency of the existing motor it is important to regulate the flux of the motor in the desired operating range. In this paper a loss model controller (LMC) based on the real coded genetic algorithm is proposed, it has the straightforward goal of maximizing the efficiency for each given load torque. In order to give more accuracy to the motor model and the LMC a series model of the motor which consider the iron losses as a resistance connected in series with the mutual inductance is considered. Digital computer simulation demonstrates the effectiveness of the proposed algorithm and also simulation results have confirmed that this algorithm yields the optimal efficiency.

**Key words:** loss minimization, efficiency, field-oriented control (FOC), induction motor (IM), real-coded genetic algorithm (RCGA)

## 1. Introduction

Induction motors (IM) are imposing themselves as a reliable and more economical choice in a large range of applications. In industry they present an important factor of control especially for autonomous electrical traction; however the motor drive losses minimization is important for two reasons: economical saving and reduction of environmental pollution. The very extensive use of induction motor implies that if losses in IM drives can be reduced by just a few percent, it will have a major impact on the total electrical energy consumption [2-5], then each 1% improvement in motor efficiency could result in savings of over \$1 billion per year in energy costs, 6-10 million tons (5.4-9.1 million tonnes) less per year of combusted coal

and approximately 15-20 million tons (13.6-18.1 million tonnes) less carbon dioxide released into the atmosphere[1].

In high dynamic performances, control schemes used in industrial applications like vector control and direct torque control, the flux is usually maintained constant equal to its nominal value; in this situation the induction motor runs efficiently around the nominal operating point [2, 3]. When the load is reduced considerably, the losses are greatly increased and the electrical energy consumption is then highly affected [3-6]. Energy saving in induction motor drives aims at controlling the motor to match the load requirement but with minimum loss. So far, many approaches have been developed in order to obtain a highly efficient IM drives. It is one of the most attractive and active subjects in the field of motion control. The techniques allowing efficiency improvement can be divided into two categories. The first category is so called loss-model controllers (LMC) and the second one is the search controllers approach (SC) [4-7, 9].

The SCs offers the advantage to be robust against the parameters variation but have a very sluggish response whereas the LMCs are very fast but parameters dependent.

In other hand the LMCs to be accurate. The model that will be used to drive the LMC algorithm must be extended to include all the loss components, such as: iron loss, copper loss, stray load loss, etc. this problem might be tackled, if necessary using online optimization algorithm.

Iron loss is modelled with an equivalent iron loss resistance placed in parallel to the magnetizing branch, however this approach add tow extras differential equations which need extra calculations, in this work a series iron loss model which is used to drive the field oriented control (FOC) and the LMC algorithm based on real coded genetic algorithm (RCGA) is used.

## 2. Motor modeling

A dynamic modeling of the IM has been widely studied in the literature, by using the famous Park transformation the six equations relating the stator and rotor voltages are reduced to four equations. This transformation is based on a set of hypothesis assumptions, among others symmetrical three phase machine and neglected saturation [16]. In this model iron loss has not been considered; as the present work focusing on the loss minimization, however this loss cannot be ignored. According to the literature there are two approaches of modeling IM taking into account the iron loss, namely parallel and series iron loss model.

### 2.1. Series iron loss modeling

The motor loss model used in this paper has been proposed by [17]. When selecting the stator currents ( $i_{sd}$ ,  $i_{sq}$ ) and the rotor fluxes ( $\Phi_{rd}$ ,  $\Phi_{rq}$ ) as state variables, the  $d$ - $q$  model for a three phase IM in the synchronous frame can be written as [15]:

$$V_{sd} = R'_s \cdot i_{sd} + \sigma \cdot L_s \cdot \frac{di_{sd}}{dt} + \frac{M}{L_r} \cdot \frac{d\Phi_{rd}}{dt} - \omega_s \cdot \sigma \cdot L_s \cdot i_{sq} + \frac{R_{fs}}{L_r} \cdot \Phi_{rd} - \omega_s \cdot \frac{M}{L_r} \cdot \Phi_{rq}, \quad (1)$$

$$V_{sq} = R'_s \cdot i_{sq} + \sigma \cdot L_s \cdot \frac{di_{sq}}{dt} + \frac{M}{L_r} \cdot \frac{d\Phi_{rq}}{dt} - \omega_s \cdot \sigma \cdot L_s \cdot i_{sd} + \frac{R_{fs}}{L_r} \cdot \Phi_{rq} - \omega_s \cdot \frac{M}{L_r} \cdot \Phi_{rd}, \quad (2)$$

$$V_{rd} = \left( R'_{fr} - \frac{M}{T_r} \right) \cdot i_{sd} + \left( \frac{R_r + R_{fr}}{L_r} \right) \cdot \Phi_{rd} - \omega_r \cdot \Phi_{rq} + \frac{d\Phi_{rd}}{dt}, \quad (3)$$

$$V_{rq} = \left( R'_{fr} - \frac{M}{T_r} \right) \cdot i_{sq} + \left( \frac{R_r + R_{fr}}{L_r} \right) \cdot \Phi_{rq} - \omega_r \cdot \Phi_{rd} + \frac{d\Phi_{rq}}{dt}, \quad (4)$$

where:

$$R'_s = R_s + R_{fs} \frac{\sigma_r}{\sigma_r + 1}, \quad R'_{fr} = R_{fr} \frac{\sigma_r}{\sigma_r + 1}, \quad T_r = \frac{L_r}{R_r} \quad \text{and} \quad \sigma_r = \frac{L_r - M}{M}.$$

**2.2. Losses of induction motor**

The IM losses can be classified in five groups: stator copper losses  $P_{js}$ , rotor copper losses  $P_{jr}$ , magnetic iron losses  $P_{fe}$ , mechanical losses  $P_m$  and stray losses. In the steady state, the stator and rotor copper losses are defined as follows:

$$P_{js} = R_s \overline{i_s^2} = R_s (i_{sd}^2 + i_{sq}^2), \quad (5)$$

$$P_{jr} = R_r \overline{i_r^2} = \frac{R_r}{(1 + \sigma_r)^2} [(i_{\mu r} - i_{sd})^2 + i_{sq}^2]. \quad (6)$$

The core losses including eddy current and hysteresis losses are given by:

$$P_{fe} = (k_h \times \omega_e \times \Phi^2 + k_e \times \omega_e^2 \times \Phi^2). \quad (7a)$$

The coefficients of hysteresis and eddy current losses may be expressed as  $k_h$  and  $k_e$  respectively which can be determined from standard no-load test data [10].

They can also be written as from the equivalent circuit of the IM in steady state where the magnetizing branch is traversed by the current  $I_\mu$  which is the sum of stator and rotor current as seen on Figure 1:

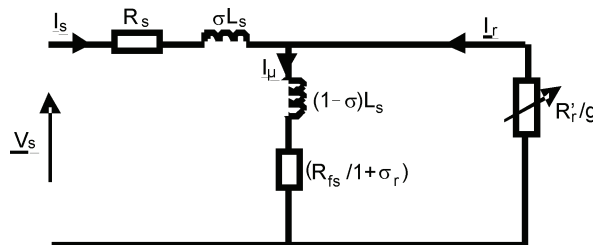

Fig. 1. Equivalent circuit of the IM

$$P_{fe} = I_\mu^2 \frac{R_{fs}}{(1 + \sigma_r)^2}, \quad (7b)$$

where :

$$R_{fs} = A \cdot f_s + B \cdot f_s^2, \quad (7c)$$

where:  $A$  and  $B$  are constants and  $f_s$  is stator current frequency.

As a reasonable approximation, the mechanical losses are dependent on the rotor speed.

$$P_m = k_m \cdot \omega_r^2, \quad (8)$$

where  $k_m$  is the mechanical loss coefficient.

As the stator currents  $i_{sd}$  and  $i_{sq}$  are regulated and the motor is controlled to be field oriented to the rotor flux, according to the following relation:

$$i_{qr} = (-M/L_r)i_{sq} \quad \text{and} \quad i_{dr} = 0.$$

The copper and core losses account for the majority of total losses, so they are the focus of the analysis. In steady state, the operating losses of the machine can be expressed from (1) to (4) as follows:

$$P_{loss} = P_{js} + P_{jr} + P_{fe} + P_m. \quad (9)$$

The mechanical losses can be neglected and the motor torque can be expressed as:

$$T_e = \frac{3}{2} p \frac{M}{L_r} \Phi_r i_{sq}. \quad (10)$$

Substituting (5), (6) and (7b) into (9) we obtain the total losses:

$$P_{loss} = (R_s + R_{fs}) \cdot i_\mu^2 + \left( R_s + \frac{R_r}{(1 + \sigma_r)^2} \right) \times \left( \frac{T_e}{p(1 - \sigma)L_s i_\mu} \right)^2. \quad (11)$$

### 3. Loss minimizing strategy

The procedure of loss minimization consists of optimizing the value of the magnetizing current ( $i_\mu$ ) for a given load torque so as to minimize the total motor losses in steady state operation.

#### 3.1. Control block diagram

In order to achieve high efficiency performance of the IM a closed vector control scheme incorporating LMC algorithm based RCGA is used.

The simplified block diagram of the proposed optimization procedure is depicted in Figure 2. The details of the LMC algorithm are discussed in the following subsections.

The principle operating structure of RCGA block represented on Figure 2 is illustrated by the flow chart of Figure 3.

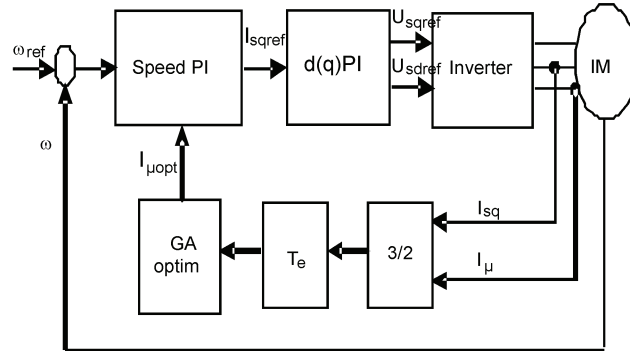

Fig. 2. Block diagram of the optimization control system

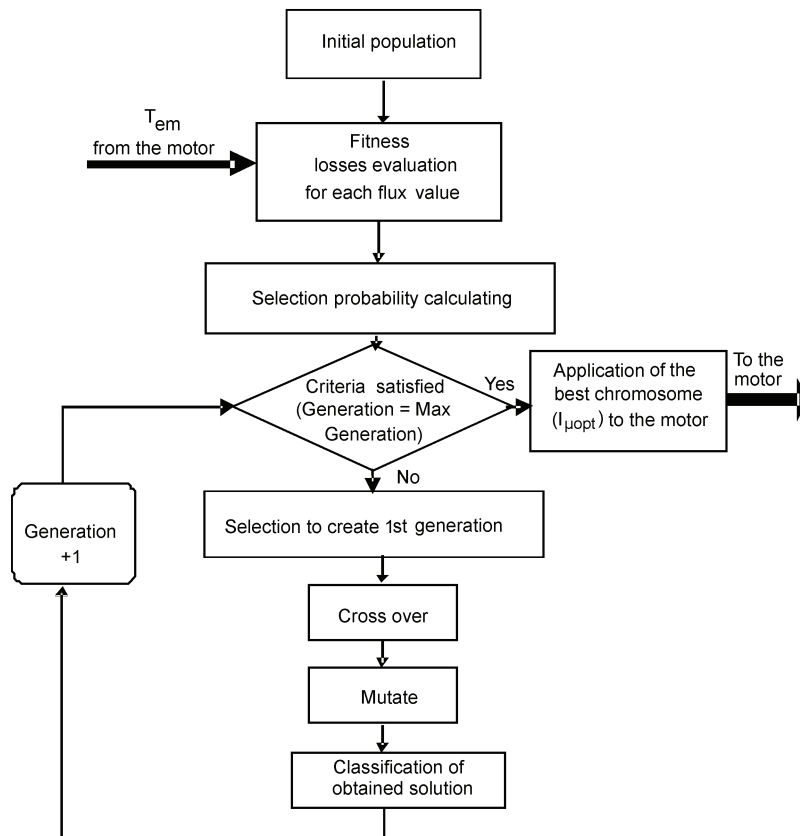

Fig. 3. Efficiency optimization flow chart by RCGA

**3.2. Improvement efficiency strategy**

Figure 4 shows the relationship between the total losses and the magnetizing current (rotor flux) under various loads it is clearly shown there is a minimum current value for each load.

The relationship between the total losses and the magnetizing current (rotor flux) under various speeds is also shown on Figure 5. These figures show that the total losses have obviously the lowest points; the highest efficiency can be achieved by tuning the rotor flux (magnetizing current in our case).

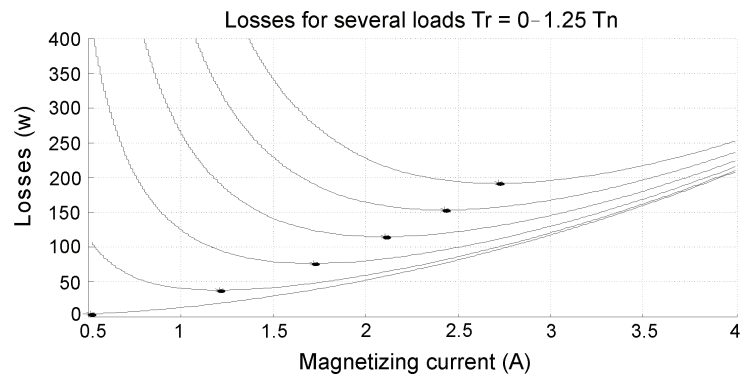

Fig. 4. Total loss versus magnetizing current at 157 rad/s

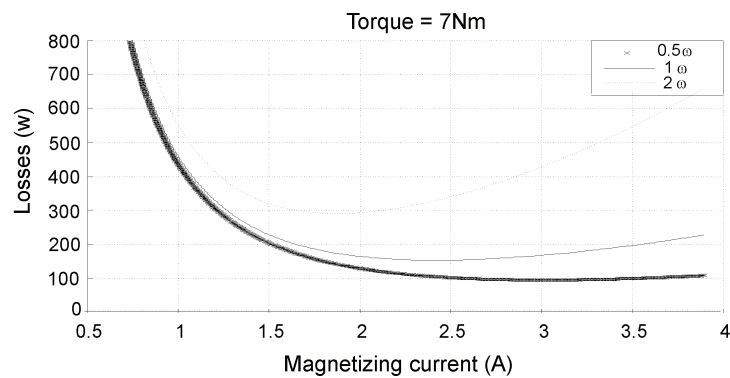

Fig. 5. Total loss versus magnetizing current at 7 Nms

Then we can conclude that the philosophy of the controller efficiency optimization aims to let the motor work at variable flux which makes efficient conversion of the electrical power within the motor drive more possible. This can be achieved by finding the optimal value of the magnetizing current that satisfies the criterion below:

$$\frac{\partial P_{loss}}{\partial i_{\mu}} = 0. \quad (12)$$

To get the best optimal solution of equation (12) we use the real coded genetic algorithms which are described in the next subsection.

#### 4. RCGA optimization procedure

The genetic algorithm was introduced by J. Holland during the 1960's. It is known as a stochastic searching algorithm inspired by principle of the natural evolution of species and capable to solving non-smooth, non-continuous and non-differentiable problems for parallel computation to find global or near global optimal solutions [10-12].

This optimization procedure consists of searching the optimum magnetizing current (flux) value for a given load torque by relying on genetic algorithm. The latter is defined as stochastic optimization technique based on the genetic natural evolution mechanism of creative beings, [7-8]. Such algorithm is found to be a powerful computational tool in seeking optimums and is considered as the most up-to-date product of artificial intelligence techniques that emulate the mechanics of natural selection and genetics. It explores, with coding parameter set, the workspace by means of mechanism of reproduction, with the target of optimizing the process selection. This mechanism comprises selection, crossover and mutation operations, [10-11, 13].

For this application, the real coded genetic algorithms are used; they have many advantages in numerical optimization over binary encoding. Efficiency of the RCGA is increased as there is no need to convert chromosomes to phenotypes before each fitness evaluation, less memory is required and there is no loss in precision by the conversion between binary and real values [14].

The application of this approach requires the introduction of an objective function which evaluates how good the fitted values of the magnetizing current are. From this function, a fitness that controls the reproduction process is derived.

The criterion to select the best individuals for reproduction is the objective (fitness) function. By proceeding in this way, the objective function adopted for this problem is the IM total losses given by equation (11). Each generation is subjected to the crossover and mutation mechanisms. The crossover consists in selecting two parent chromosomes randomly in order to generate two new individuals. The mutation follows crossover and is used to insure that useful genetic data that could have been disregarded during crossover is not permanently lost.

The procedure of real-coded genetic algorithm is outlined as follows:

- 1) Initial generation: the RCGA begins by randomly  $N$  individuals inside certain range and forms initial generation.
- 2) Fitness evaluation: every individual's fitness is calculated according to the fitness function (eq. (11)).
- 3) Reproduction: parent individuals are sorted from big fitness function value to small one, and excellent individuals from the headmost are directly passed to offspring generation and the rest is put in matching pool.

- 4) Crossover and Mutation: Those operations are finished in matching pool, and the generated individuals are sent to offspring generation.
- 5) Iteration: the RCGA runs iteratively repeating the procedures 2-4 until population convergence condition is met or the maximum number of iteration is reached.

## 5. Performance investigation

The simulation of efficiency optimization of IM using genetic algorithms is performed by using Matlab/Simulink software; the results of different cases are given below.

The nameplate-rated characteristics of the used induction machine are shown in Table 1 in the appendixes.

The aim to using the optimization algorithm was to let the motor working at variable flux, also to proof the effectiveness and the robustness of the proposed algorithm the motor drive was tested at different range of speeds highest and lowest than the nominal speed.

Some simulation results are given on Figures bellow.

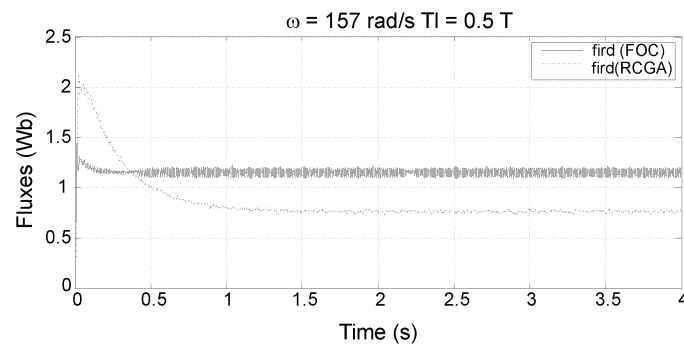

Fig. 6. Motor fluxes for 0.5 T

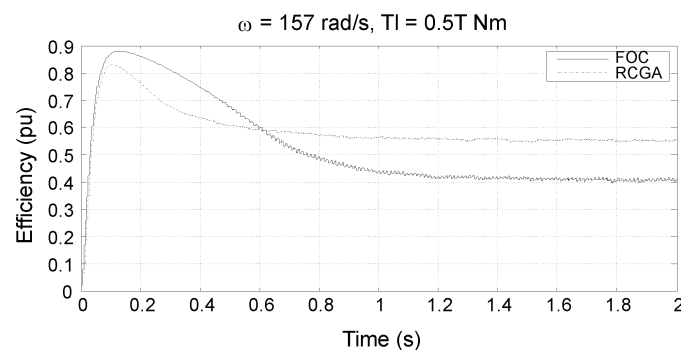

Fig. 7. Motor efficiency at 0.5 T

We can see the flux must be reduced according to the efficiency improvement strategy. It's obvious on Fig. 6, that the flux is decreasing when we switch from the case without optimiza-



tion (FOC) to the case with optimization (RCGA). Furthermore, one can note that the using of RCGA provide the best optimal value of the flux. This decreasing flux has a direct influence on the efficiency which is improved. At each operating point, the optimal efficiency is reached when using the optimization algorithm as we can see on Fig. 7. A definite improvement in efficiency in the transient region is noted as well.

Figures 8(a), 9(a) and 10(a) show and confirm that there is a great efficiency improvement when using the RCGA optimization algorithm compared with the non optimization case (FOC), and we can see that the optimization method gives best results at light loads as seen on the zooms. Also we can note that the motor works at its optimal efficiency at different load levels when the optimization algorithm is introduced in the command.

Note that for the case of low speed as seen on Figure 8, the motor efficiency is improved only over the light load region when using real coded genetic algorithms.

These results demonstrate that the proposed method saves energy than the conventional one as it's shown on Figures 11(a) and 11(b) where the motor works at nominal speed. Thus we have been able to achieve satisfactory efficiency and torque for IM drive.

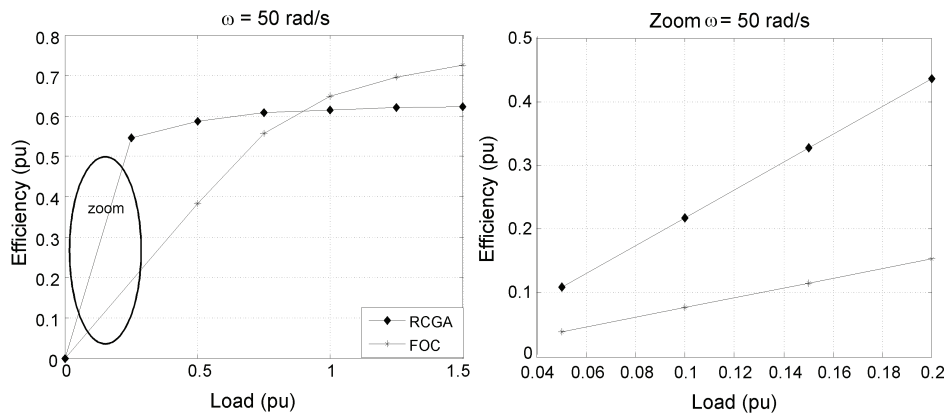

Fig. 8. Motor efficiency for low speed

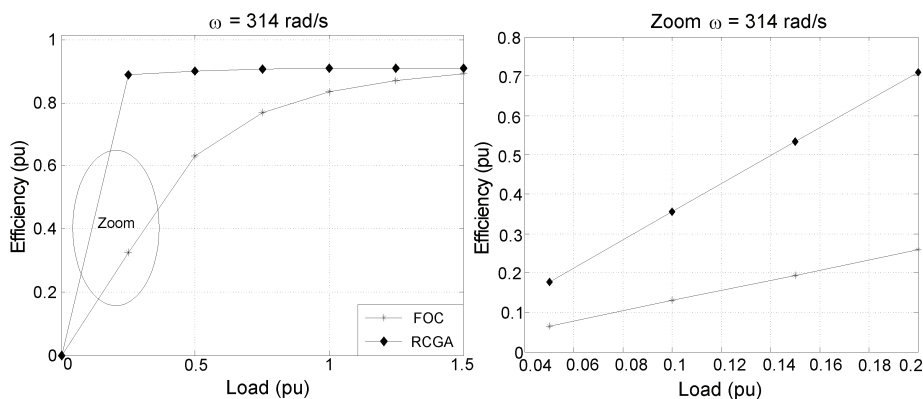

Fig. 9. Motor efficiency for high speed

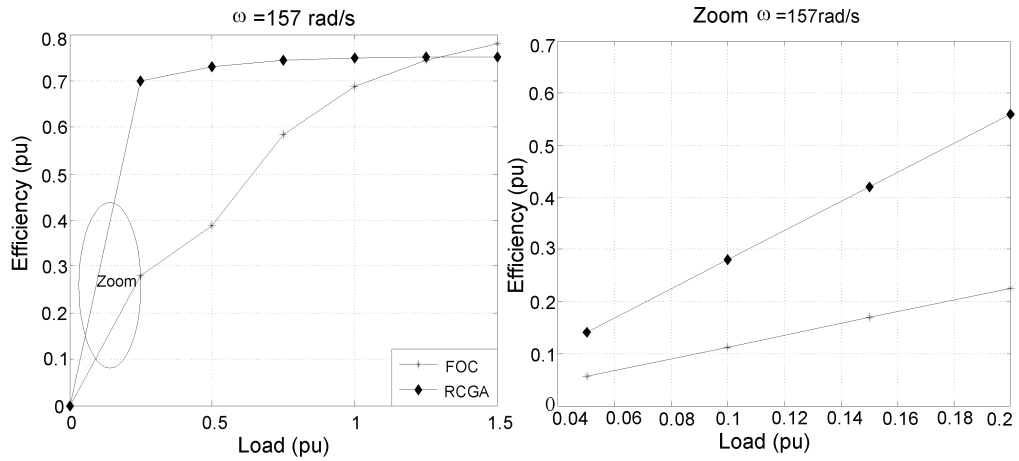

Fig. 10. Motor efficiency for nominal speed

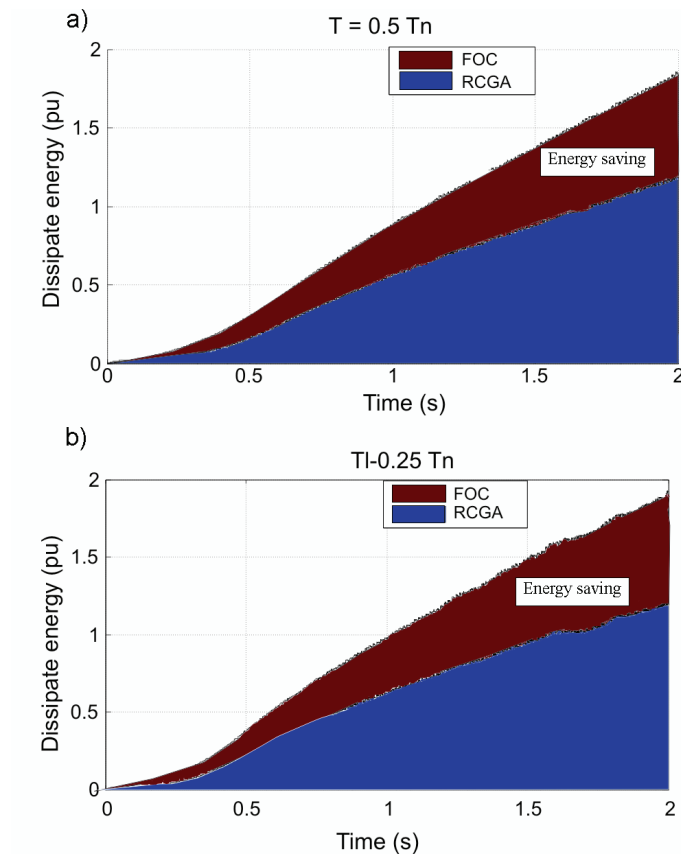

Fig. 11. a) Motor drive energy saving at 3.5 Nm; b) motor drive energy saving at 1.75 N

## 6. Conclusion

In this paper an on-line efficiency optimization algorithm based on real-coded genetic algorithm is proposed to be implemented for induction motor drives. The advantages of using real coded genetic algorithms have been highlighted. Extensive simulation results of proposed and conventional FOC methods are investigated and compared and the superiority of the former is confirmed.

The yielding simulation results show immediate improvement in efficiency when the on-line RCGA algorithm is applied with the IM slightly loaded that usually suffers of low efficiency values.

It appears that non-negligible energy can be saved, with the using of the RCGA.

## Appendixes

Table 1. Rating and parameters of induction motor

Parameters	Symbols	Values	Units
Power	$P$	1.1	kW
Number of pairs of poles	$n_p$	2	
Stator resistance	$R_s$	8	$\Omega$
Rotor resistance	$R_r$	3.1	$\Omega$
Total leakage factor	$\sigma$	0.12	
Mutual inductance	$M$	0.443	H
Stator self inductance	$L_s$	0.47	H
Rotor self inductance	$L_r$	0.47	H
Inertia	$J$	0.06	IS
Viscose friction coefficient	$f$	0.00	IS
Rated load torque	$T_L$	7	N · m

Table 2. Genetic algorithms parameters

Parameters	Values
Population size	20
Crossover probability	0.75
Mutate probability	0.01
Maximum generation number	20

## References

- [1] Ramesh L. et al., *Efficiency optimization of induction motor using a fuzzy logic based optimum flux search controller*. IEEE International Conference on Power Electronics Drives and Energy Systems (PEDES06), 12-15 Dec., pp. 1-6 (2006).
- [2] Branko Blanus et al., *An improved search based algorithm for efficiency optimization in the induction motor drives*. XLII Konferencija, za ETRAN, Hecy-Novu (2003).
- [3] Kirischen D.S., Novoty D.W., Lipo T.A., *Optimal efficiency control of an induction motor drive*. IEEE Trans. on Energy Conversion EC-2(1): 70-76, March (1987).

- 
- [4] Ghozzi S. et al., *Energy optimization of induction motor drives*. IEEE International Conference on Industrial Technology (ICIT), 8-10 Dec., 2: 602-610 (2004).
  - [5] Bose B.K., *Power electronics and AC drives*. Prentice Hall, USA (2002).
  - [6] Poirier E. et al., *Loss minimization control of induction motor drives based on genetic algorithms*. Electric Machines and Drives, 2001 IEEE International Conference, pp. 475-478 (2001).
  - [7] Jinchuan. Li et al., *A new optimization method on vector control of induction motors*. Electric Machines and Drives, 2005 IEEE International Conference, 15-18 May, pp. 1995-2001 (2005).
  - [8] Sheble G.B., Briting K., *Refined genetic algorithm – economic dispatch example*. IEEE Trans. on Power Systems, Feb., 10(1): 117-124 (1995).
  - [9] Golberg D.E., *Genetic algorithms in search, optimization and machine learning reading*. MA: Addison-Wisley, USA (1989).
  - [10] Murphy J.M.D., Honsinger U.B., *Efficiency optimization of inverter-fed induction motor drives*. Conf. Rec. IEEE Ind. Appl. Soc., pp. 544-552 (1982).
  - [11] Renders J.M., *Genetic algorithms and neural network*, Hermès, Paris (1995).
  - [12] She K.L. et al., *Speed estimation of an induction motor drive using an optimized extended kalman filter*. IEEE Transaction on Industrial Electronics, Feb., 49(1), pp. 124-133 (2002).
  - [13] Leigh J.R., *Control theory. Second edition*. The Institution of Electrical Engineers, London (2004).
  - [14] Zidani F. et al., *Fuzzy efficient-optimization controller for induction motor*. IEEE Power Engineering Review, October, pp. 43-44 (2000).
  - [15] Z. Rouabah et al., *Optimal efficiency of a fuzzy controller in a field oriented control induction motor drive*. 4th International Conference on Electrical Engineering CEE06, Batna, Algeria, 07-08 November, pp. 135-138 (2006).
  - [16] Dal. Y, Ohm, *Dynamic model of induction motors for vector control*. Drivetech, 17 Inc., Blacksburg, Virginia (2000).
  - [17] Mendes E., Razek A., *A simple model for core losses and magnetic saturation in induction machines adapted for DirectStatorFluxOrientationControl*. IEE/PEVD'94Conference, pp 192-197 (1994).