

Comparative investigation of SiC and Si power electronic devices operating at high switching frequency

K. ZYMMER* and P. MAZUREK

Electrotechnical Institute, 28 Pożaryskiego St., 04-703 Warszawa, Poland

Abstract. The paper presents results of measurements of the reverse recovery current and dynamic forward voltage of the silicon carbide (SiC) Schottky diodes operating at a $500 \text{ A}/\mu\text{s}$ current slope. These data were compared with the corresponding parameters determined for ultrafast silicon (Si) diodes. Results of power losses measurement in SiC Schottky diodes operating at switching frequency range of (10–200) kHz are presented and compared with corresponding data of ultrafast Si diodes. Also, results of power losses measurements in transistors of dc voltage switch are shown. Investigations were conducted with a SiC and the ultrafast Si freewheeling diode at the transistor switching frequency of 100 kHz. The results of measuring power losses dissipated in the dc converter with a SiC Schottky diode and the ultrafast silicon diode are also presented.

Key words: semiconductor devices, silicon carbide, high frequency converters.

1. Introduction

Continuous research on new technological materials leads to production of semiconductor devices with properties essentially more advantageous than the corresponding devices based on silicon. This concerns especially the dynamic parameters, being particularly important for converting electrical energy in power electronic systems with high switching frequency and high operation temperature. One of the materials used presently in the semiconductor technology is the silicon carbide (SiC). It is characterized by following parameters:

- wide band – gap $E_g = 3.2 \text{ eV}$ (for pure silicon Si – 1.1 eV),
- temperature $T_{j \max} = 650^\circ\text{C}$ (Si – 200°C),
- carrier life time (for 1 kV) $\tau_p = 40 \text{ ns}$ (for Si – 1200 ns),
- maximum of continuous current density $j = 400 \text{ A}/\text{cm}^2$ (for Si – $100 \dots 200 \text{ A}/\text{cm}^2$) [1].

New SiC Schottky diodes are characterized by voltage and current parameters of 1200 V and some tens amperes. Basing on these devices it is already possible to build converters with power values of several, and in case of parallel connection, of above a dozen of kilowatts. These converters can operate at frequencies higher than those allowed by corresponding Si devices.

As SiC devices are relatively new, it is important to learn their properties, especially by experimental tests performed on converters operating at high switching frequency.

Actually many research and developing centres lead investigations in parts of semiconductor SiC devices [1–5, 7–11].

This paper presents experimental results of dynamic parameters measurements on Schottky SiC diodes and ultrafast Si diodes. The power losses generated in these diodes and in cooperating transistors at high switching frequency are also presented.

2. Power losses in diodes and transistors operating at fast current commutation

In diodes operating in converter systems with current commutation, there occur power losses resulting from static forward characteristics and power losses related to current commutation, when a diode goes over from forward to reverse operation and conversely operation. Power losses related to current commutation depends of course on switching frequency. If the energy released in a device at switching-on and switching-off amounts to $(E_{on} + E_{off})$ then the power loss generated in this device at a switching frequency of f is equal to $(E_{on} + E_{off}) \times f$.

The energy released in diodes in transient states at given values of voltage, current and the slope of its change, depend on the properties of those devices. These properties are determined by the values of the dynamic forward voltage and of the reverse recovery current. The dynamic properties of diodes with transistors in the commutation process have essential effect on the energy loss generated in the transistor at its switching-on.

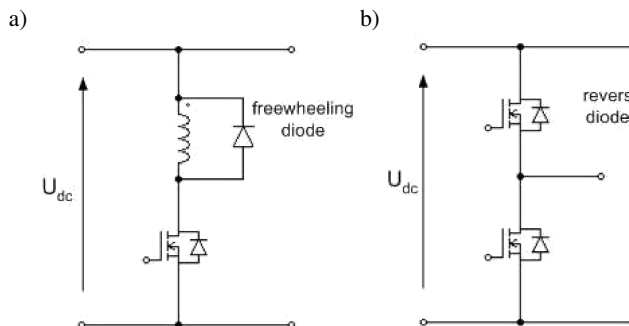
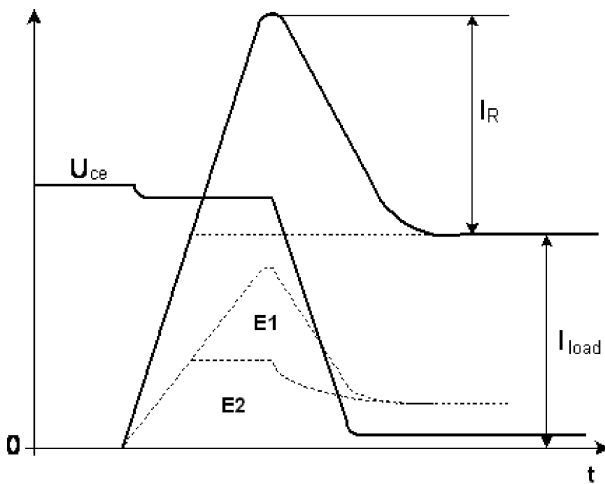

Fig. 1. SiC diodes operating in power electronic circuit: a) freewheeling diode in dc chopper, b) revers diode in converter module

*e-mail: npm@iel.waw.pl

In practice almost every topology of a transistor converter contains freewheeling or reverse diodes (Fig. 1). In the converter systems mentioned above the current commutation in diodes effects the processes of switching-on currents by transistors and they generate additional power losses in transistors. In the process of taking over the main current by the transistor being switched-on, the diode goes over from the forward state into the reverse state and its reverse recovery current flows through this transistor (Fig. 2).

The area denoted in Fig. 2 as E1 represents energy losses in the transistor, generated by the reverse recovery current of the diode co-operating with the transistor in the commutation process. The area E2 determines energy losses in the transistor originating from the load current I_{load} of the main circuit.



U_{CE} – voltage collector-emitter
 I_{load} – load current in steady state
 I_R – peak value of the diode reverse recovery current

Fig. 2. Voltage and current of the transistor in the switching-on process (pictorial figure)

Thus, the power (energy) loss generated in the transistor in the process of its switching-on depends on: current and voltage values in the dc circuit, on transistor properties, and on the reverse recovery current of the diode co-operating with the transistor during its switching-on.

3. Investigations into dynamic properties of diodes

Measurements of the dynamic forward voltage and reverse recovery current of a ultrafast Si diode and of a SiC Schottky diode were performed in the system shown in Fig. 3. The parameters of those diodes are presented in Table 1.

The tests were conducted in the system of a dc voltage controller, which circuit is shown in Fig. 3. The system was supplied with a dc voltage of 200 V, the current adjusted to 10 A and the slope of its change was about 500 A/μs. An IGBT transistor HGTG12N60A4D of the firm Fairchild, with a rated current of 60 A and voltage of $U_{CE} = 600$ V was used as the switching device.

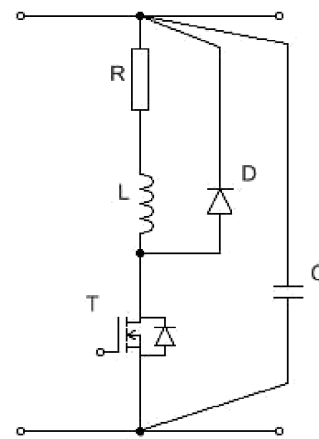

D – diode under test
 T – transistor switch
 Fig. 3. Circuit of the test system

Table 1
 Parameters of the diodes under test

Parameter		Diode type	
		IDT 16S60C (SiC)	DSEP15-06A (Si)
Backward voltage	V_{RRM}	600 V	600 V
Forward current	I_F	24 A, $T_c < 100^\circ\text{C}$	15 A, $T_c < 140^\circ\text{C}$
		1.5 V, $I_F = 16$ A, $T_j = 25^\circ\text{C}$	2.04 V, $I_F = 15$ A, $T_j = 25^\circ\text{C}$
Voltage drop forward	V_F	1.7 V, $I_F = 16$ A, $T_j = 155^\circ\text{C}$	1.35 V, $I_F = 16$ A, $T_j = 150^\circ\text{C}$
Max. temperature of junction	T_j, T_{tg}	175°C	175°C
Type of casing		TO220	TO220
Thermal resistance	$R_{th,JC}$	1.1 K/W	1.6 K/W
Total capacitive charge	Q_e	38 nC	
Switching-off time	t_e	< 10 ns, 400 V, $I_F = I_{Fmax}$, 200 A/μs, 150°	35 ns, 30 V, $I_F = 1$ A, 100 A/μs, 25°C

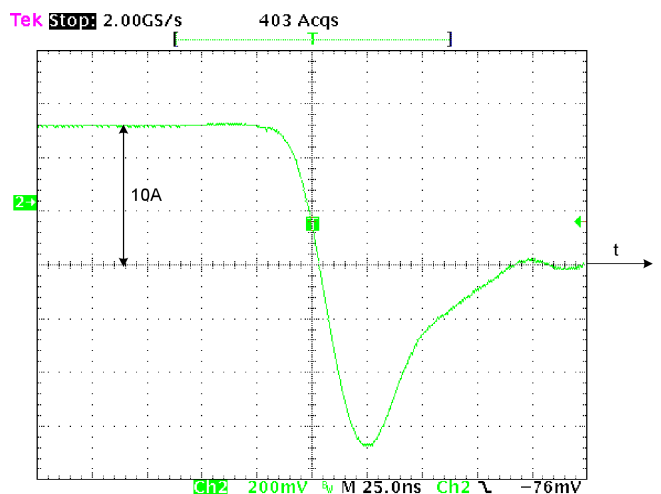

Fig. 4. Current of the Si diode DSEP15-06A in the commutation process

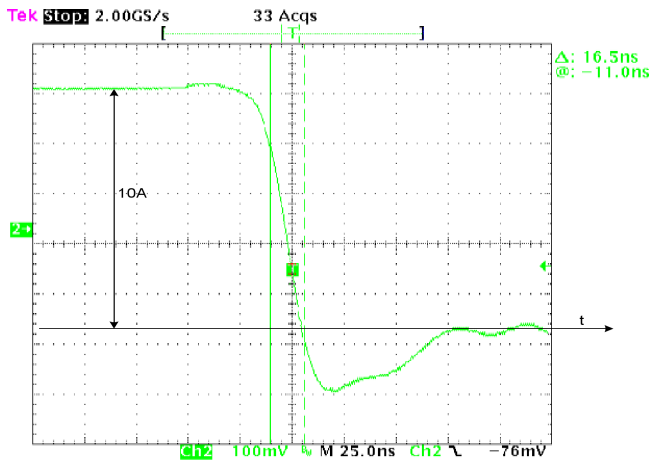

Fig. 5. Current of the SiC diode IDT16S60C in the commutation process

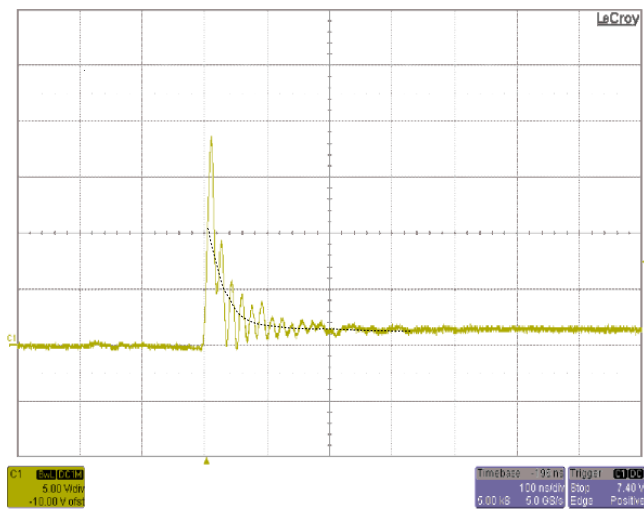

Fig. 6. Dynamic voltage drop in the forward direction of a Si diode

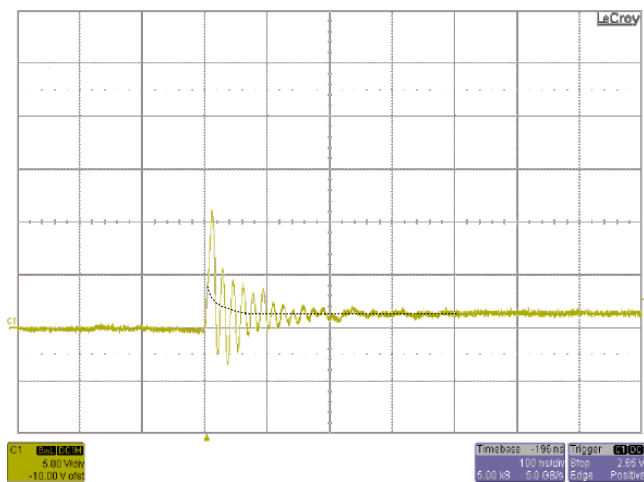

Fig. 7. Dynamic voltage drop in the forward direction of a SiC diode

The peak value of the reverse recovery current of the Si diode achieves 13.6 A. Correspondingly, the value determined for the SiC diode is 2.5 A.

The parameter of diodes characterizing the properties of those devices in the transient process is the dynamic forward voltage. The value of this parameter, similarly as that of the reverse recovery current, effects the power losses generated in the device, particularly in high switching frequency and at high slope of the diode forward current. The measurements of the dynamic forward voltage of the Si diode and the SiC Schottky diode were performed at a forward current slope of 500 A/ μ s.

The measurement results are shown in Figs. 6 and 7.

Voltage oscillations are the result of the resonance of junction capacitance and the inductance of the internal connections of diodes. The dotted line presents the averaged variation of the forward voltage which can be interpreted as the component depending on the physical properties of the semiconductor material. The highest initial averaged value of the dynamic forward voltage of the Si diode is equal 11 V and the time which passed to gaining the stationary value of the voltage across the diode was determined as 200 ns. The corresponding values for the SiC diode is equal 4 V and 100 ns. Thus, also at switching-in the SiC Schottky diode shows more advantageous properties than the ultrafast, Si diode.

4. Measurements of power losses in diodes

Investigations were conducted in the system of a dc voltage controller whose schematic diagram is shown in Fig. 3. The system was supplied with dc voltage of 200 V.

The switching frequency of the power transistor was varied within (10–200) kHz. The peak value of current pulses during tests was retained at the level of 10 A at a duty cycle of 0.5, independent of switching frequency.

For determining the total power losses in semiconductor devices the thermal method was applied. The thermal resistance of the heat sink $R_{th(HS)}$ on which the tested devices were fixed was the factor used to determine power losses in conditions of high frequency. This value was determined when the semiconductor device fixed on the heat sink was loaded by direct current and at natural cooling. The value of the loading current was changed during test in order to obtain the dependence $R_{th(HS)}$ from power losses. The following were measured in thermally steady state: power losses in the device P_{tot} , temperature of the heat sink T_{HS} , ambient temperature T_A . The thermal resistance of the heat sink for a given measuring point is given by: $R_{th(HS)} = (T_{HS} - T_A) / P_{tot}$. Measuring this values T_{HS} and T_A , at a known value of $R_{th(HS)}$ the total power loss dissipated in the tested semiconductor device at high frequency conditions can be determined. In the opinion of the Authors, the thermal method gives the most credible results of power loss measurements at high switching frequency, because it is not sensitive to electromagnetic interferences generated in such kind of systems.

Table 2 presents results of power loss measurements in Si and SiC diodes.

Table 2
Power losses measured in diodes

Conditions of loading		Power losses [W]	
Current	Frequency	SiC diode	Si diode
10 A	DC (continuous conduction)	13.10	11.95
	10 kHz	6.55	6.90
10 A peak at a filling factor 1/2	60 kHz	6.58	6.80
	100 kHz	6.62	14.70
	200 kHz	6.70	- ¹⁾

¹⁾ measurement given up because of exceeding the permissible temperatures of junction

In conditions of dc loading, the losses in the SiC diode are about 10% higher than in the Si diode. Comparable power losses in those diodes occur at a transistor switching frequency of 10 kHz whereby the power losses evolved in the SiC diode increase by only about 2% as the frequency increases from 10 kHz to 200 kHz. However, power losses in the ultrafast Si diode increase with frequency, and at 100 kHz they reach value over two times higher than at 10 kHz. This frequency was assessed as the limit for the Si diode at given cooling conditions. Thus, the measurement results presented above confirm the advantages of SiC Schottky diodes, and the development perspectives of SiC technology in the high switching frequency converter technology.

5. Measurements of power losses in the transistor

Power losses in the switching transistor of the type IXKR40N60C produced in the technology CoolMOS were determined in the measuring system presented above for operation conditions with a SiC Schottky diode type IDT16S60C and with a Si diode type DSEP15-06A. The voltage-current conditions in the system corresponded to those presented above. Measurements of power losses were conducted at 100 kHz switching frequency.

The power loss measured in those conditions:

- for Si diode 16.2 W,
- for SiC diode 8.3 W.

The above measurement results show how the dynamic properties of a diode affect the power losses, generated in the transistor, current commutation process, especially for high switching frequency.

6. Comparison of total losses

The total (switching and conduction) losses for transistor switch with Si and SiC diodes versus switching frequency are presented in Fig. 8. It shows clearly that losses in Si diodes increase quickly with switching frequency and for 60 kHz achieves value with for SiC diodes is about 200 kHz.

This investigation were conducted in DC converter of power 3 kW.

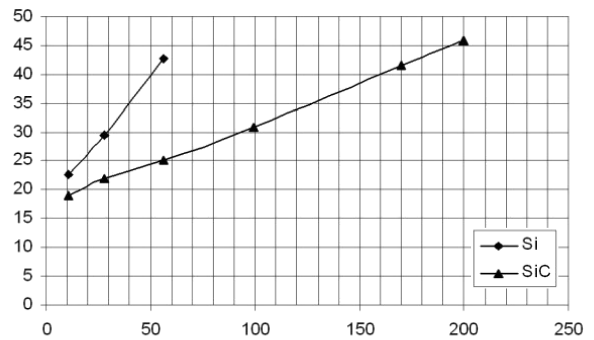

Fig. 8. The total (switching and conduction) losses for transistor and Si or SiC diodes versus switching frequency

7. Conclusions

Measurements of reverse recovery current performed at the same values of forward current and of the slope current at crossing the zero ($I_F = 10$ A, $di_R/dt = 500$ A/ μ s) for a SiC diode and for Si diode showed that the current peak value is for a SiC device lower by several (5–6) times than in case of an Si diode.

Values of dynamic forward voltage measured in conditions of current slope of 500 A/ μ s were, for SiC diode, two times lower than the values determined for Si diode. This relationship concerns both the peak value of voltage oscillations (caused by own capacitance and inductance of the diode) as well as the averaged value of that parameter.

The tested types of the SiC and Si diodes at loading by dc current of 10 A showed similar values of power losses. Power losses in SiC diode determined at current commutation frequencies varied within (10–200) kHz, rise insignificantly in the whole frequency range. However, the corresponding values of power losses determined in the same conditions of current commutation and frequency range for Si diode increase distinctly with rising switching frequency. At frequency of 100 kHz the power losses in Si diode were over two times higher than in a SiC device. This frequency is being determined as the limit value in given cooling conditions. As the SiC diode with frequency rising within (10–200) kHz shows only small rise in power losses, it can be assessed that it will satisfy requirements also at current commutation frequencies higher than 200 kHz.

Using an SiC diode as a diode co-operating with the transistor in the current commutating process, essentially reduces the power losses in the device as compared with the Si diode.

For example at the commutation frequency of the transistor forward current of 10 A and frequency of 100 kHz, the power losses in the switching transistor type IXKR40N60C produced in the CoolMOS technology using an ultrafast Si diode were approximately two times higher than the corresponding losses generated with the SiC Schottky diode. Summarizing, it can be stated that in high switching frequency converters current commutation using SiC diodes causes essentially lower losses in both diodes and transistors even in a case of the use of ultra fast Si diodes.

REFERENCES

- [1] A. Michalski and K. Zymmer, "Investigation of properties of power electronic devices made of silicon carbide (SiC) under conditions of current commutation with high frequency", *Works of Electrotechnic Institute 243*, CD-ROM (2009), (in Polish).
- [2] R. Barlik, J. Rąbkowski, and M. Nowak, "Power electronic systems with silicone carbide devices – present state and perspectives", *VI Nat. Conf. Electronics 1*, CD-ROM (2007).
- [3] J.M. Hancock, "Novel SiC diode solves PFC challenges", *Materials of the Firm Infineon Technologies. Power Electronics Technology 1*, www.pwerelectronics.com (2006).
- [4] S. Jr Hodge, "SiC Schottky diodes in power factor correction", *Power Electronics Technology 1*, www.pwerelectronics.com (2004).
- [5] A. Konczakowska, A. Szewczyk, J. Kraśniewski, and M. Oleksy, "Measurements of parameters and static, dynamic, noise and thermal characteristics of SiC devices", *VI Nat. Conf. Electronics 1*, CD-ROM (2007).
- [6] R. Richmond, "Hard-switched silicon IGBTs? Cut switching losses in half with silicon carbide Schottky diodes", *Materials CREE 1*, CD-ROM (2010).
- [7] W. Janke, A. Hapka, and M. Oleksy, "DC characteristics of the Schottky diodes", *Bull. Pol. Ac.: Tech.* 59 (2), 183–188 (2011).
- [8] P. Ning, R. Lai, D. Huff, F. Wang, K.D.T. Ngo, V.D. Immanuel, and K.J. Karimi, "SiC wireband multichip phase – leg module packaging design and testing for harsh environment", *IEEE Trans. on Power Electronics* 25 (1), 16–23 (2010).
- [9] J. Richmond, S.H. Ryu, M. Das, S. Krishnaswami, S. Hodge, A. Agarwal, and J. Palmour, "An overview of Cree silicon carbide power devices", *Power Electronics in Transportation 1*, CD-ROM (2004).
- [10] Q. Zhang, R. Callanan, M.K. Das, S.H. Ryu, A.K. Agarwal, and J.W. Palmour, "SiC Power devices for microgrids", *IEEE Trans. on Power Electronics* 25 (12), 2889-2896 (2010).
- [11] R. Singh and J. Richmond, "SiC power Schottky diodes in power-factor correction circuits", *Materials CREE*, www.cree.com/power (2010).
- [12] *LED chips, LED Components, Lighting Products, Power-Switching and Wireless Communications Devices*, www.cree.com (2011).