

EXPERIMENTAL INVESTIGATIONS OF INTERTURN FAULTS IN TRANSFORMER WINDING USING FREQUENCY RESPONSE ANALYSIS

Andrzej WILK

Politechnika Gdańska, ul. G. Narutowicza 11/12, 80-233 Gdańsk
tel: 058 347 1087 fax: 058 341 0880 e-mail: awilk@ely.pg.gda.pl

Abstract: This paper presents sensitivity of Frequency Response Analysis method applied to detection of interturn faults. Frequency response has been carried out on a special Reduced Scale Traction Transformer (RSTT). The RSTT has the wound iron core and eight coils arranged in the "core" type of construction. Many papers have been published on FRA techniques for detection of shorted turns but still there are some issues that need to be addressed. The simulated faults presented in the paper include different values of shorting resistance and different localization of short-circuited turns. From the measurements performed on the transformer without faults, it can be concluded that handmade coils with the same type of construction differ significantly in frequency response. It is also concluded that FRA magnitude spectrum is sensitive to short-circuit, but for some ranges of shorting resistance only. FRA magnitude spectrum also changes with respect to localization of short-circuited turns. The frequency response showed shift in waveforms? in case of some resonant frequencies.

Keywords: Traction transformer, Interturn fault, Frequency response analysis.

1. INTRODUCTION

Frequency Response Analysis (FRA) is a powerful and non-intrusive diagnostic test technique. This method is now established as a proven tool for detecting a wide range of faults. Windings of a transformer can be modeled as a network of lumped and coupled conservative (induction coils, capacitors) and dissipative (resistors) elements. While a fault in the winding occurs and it influences the values of inductances, capacitances and resistances the frequency response also changes accordingly. FRA method consists in measuring the ratio of test voltage U_T signal to reference voltage U_R signal at both ends of the tested winding over a wide range of frequencies [1]. The method is carried out by the use of a sweep frequency voltage source. A fault presence can be concluded from comparison of the results of these measurements with a reference set. Differences can indicate faults in transformer windings. Some faults cause different changes to FRA results, but there are faults that generate a similar frequency response [2].

FRA method is mainly applied to verify the mechanical integrity of transformers. Such faults as winding movements, loss of clamping pressure, disc movements etc. are essential for this integrity and affect the frequency response [1-4]. FRA is also effective for detection of shorted turns [2,3] in

transformer windings. Other types of faults (loosened turns, deformation of coils) can be determined if some conditions are fulfilled [2,5].

Results of interturn faults presented in many papers have not been taking into account the values of shorting resistance. Hence, this study is aimed at investigating of frequency response generated from tested winding at various values of shorting resistance. Furthermore the influence of placement where the short circuit had occurred on frequency response was tested.

2. DESCRIPTION OF TESTED TRANSFORMER AND MEASUREMENT CIRCUIT USED

The transformer used for the fault simulation was a special Reduced Scale Traction Transformer (RSTT). Mathematical model of the RSTT suitable for low frequency is described in [6]. The schematic diagram of the FRA experimental setup is shown in figure 1.

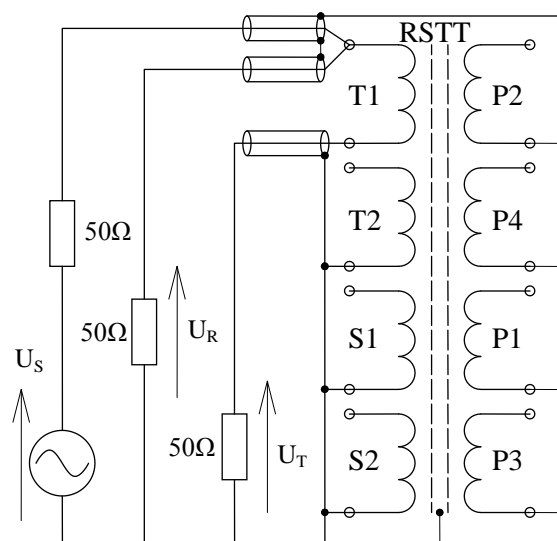

Fig. 1. Equivalent circuit for FRA measurement: RSTT – reduced scale traction transformer, U_S – injected voltage signal from sweep frequency generator, U_R – reference voltage signal on one end of the winding, U_T – test voltage signal on the other end of the winding. All voltage signals are carried by coaxial cables

The RSTT has the wound iron core and eight coils arranged in the “core” type of construction. The arrangement of the coils in the considered transformer are depicted in figure 2. The primary windings are made of three parallel sections. The coils denoted P2 and P4 make two sections of the primary traction winding. The coils denoted P1 and P3, connected in series inside the transformer, form a single section referred to as the primary auxiliary winding. The coils labeled T1 and T2, not connected inside the transformer, form two sections of the traction secondary winding. The coils S1 and S2, connected in series inside the transformer, are the auxiliary secondary winding. The traction windings (P2, T1, P4, and T2) have 190 turns. The auxiliary windings (P1, P3, S1, and S2) have 95 turns. All windings are composed of 6 layers connected in series. Each layer has 6 terminals (two coils having single turn and the third coil with the rest of turns in the layer). This assembly of particular elementary coils enables simulation of interturn faults in each layer of particular primary and secondary windings. Figure 3 shows the external appearance of the RSTT without tank. Some ratings and design details of the RSTT are shown in table 1.

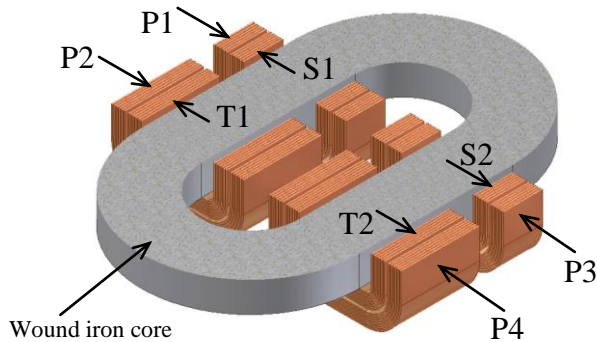

Fig. 2. View of the 3D computer model of the RSTT in longitudinal section and arrangement of primary and auxiliary windings



Fig. 3. External view of the RSTT. The terminal board of secondary windings is visible on the right hand side

Table 1. Some ratings and design details of the RSTT

Rated power	19.3 kVA
Number of windings (Primary/Secondary)	4/4
Service frequencies	16⅔, 50, 60 Hz
Rated voltages (Primary/Secondary)	230/230 V
Rated current of particular windings	28 A
Nature of the dielectric	Dry insulation
Approximate dimensions [mm] (iron core and windings only)	240/500/615

Other components of experimental setup are: sweep frequency sinusoidal voltage U_S generator, voltage measuring system for measurement of the reference signal U_R on one end of the tested winding, voltage measuring system for measurement of the test signal U_T on the other end of the tested winding, properly shielded 50 Ω coaxial cables. It is essential during FRA measurement to use the standardized internal impedance of sweep frequency generator, and voltage measuring systems. In case of FRA measurements on transformers their internal impedances should have the same value equal to 50 Ω . Non tested windings and iron core were connected to common earth.

The voltage source signal U_S was obtained from the generator AFG 3011 type (Tektronix) giving constant output of 10Vpp in frequency range 0 Hz to 10 MHz (sampling rate 250 MS/s). The voltage signals U_R and U_T were measured by means of 4 channel digital oscilloscope TDS 5034B type (Tektronix) with bandwidth range from 0 Hz to 350MHz (sampling rate 5 Gs/s).

3. DESCRIPTION OF THE TEST METHOD

The implementation of FRA method used in this paper was based on simultaneous measurements of the reference voltage and the test voltage signals. Next Fast Fourier Transform (FFT) was used to determine spectrum $R(j\omega)$ of the reference signal and spectrum $T(j\omega)$ of the test signal. These two spectra are then used to determine the ratio $T(j\omega)/R(j\omega)$. This ratio is used as argument of functions to calculate amplitude $A(\omega)$ of frequency response and phase $\phi(\omega)$ of frequency response. These functions are defined as

$$A(\omega) = 20 \log_{10} \left| \frac{T(j\omega)}{R(j\omega)} \right|, \quad \phi(\omega) = \tan^{-1} \left[\frac{T(j\omega)}{R(j\omega)} \right] \quad (1)$$

Results presented in this paper were made in the frequency range 50kHz to 8MHz (linear increase of frequency). Specially prepared shorting elements (shorting resistances) having different values of resistance were connected to terminals of chosen coils having single turn to simulate interturn faults. Figure 4 shows one of the shorting resistances and its connection to terminals of a coil to be shorted.

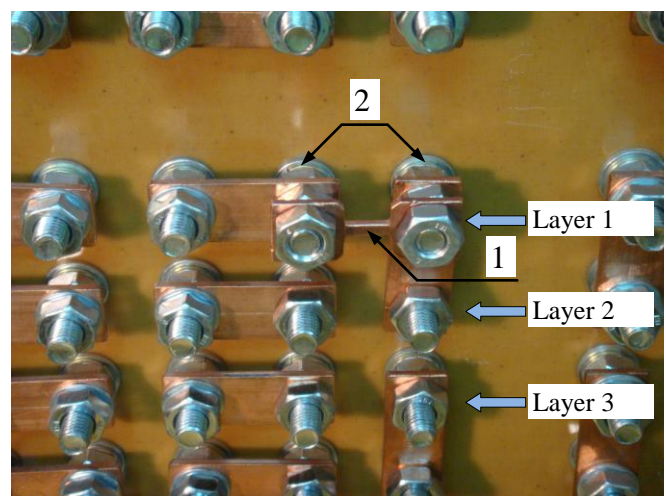

Fig. 4. View of the connection of shorting resistance to simulate interturn fault in the layer 1 of the T2 winding: 1-shorting resistance, 2- terminals of the coil to be shorted in the layer 1

Values of shorting resistances were measured taking into account the contact between the shorting element and the screw.

4. EXPERIMENTAL RESULTS

4.1. Comparison of symmetrical T1 and T2 windings with no interturn faults

First of all the FRA was carried out on symmetrical T1 and T2 windings without interturn faults. The measured results of FRA amplitude response $A(f)$ as function of frequency f of T1 and T2 windings are shown in figure 5.

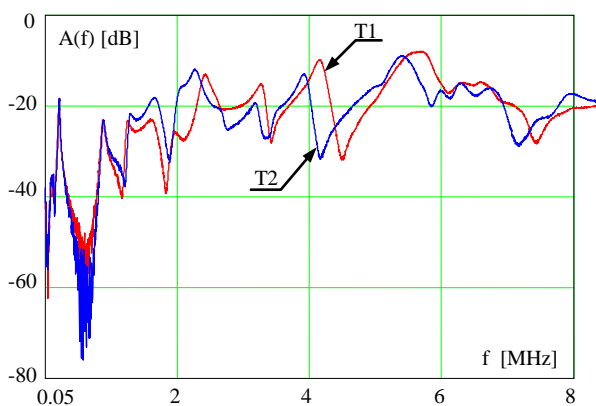

Fig. 5. FRA amplitude responses $A(f)$ of T1 and T2 symmetrical windings without interturn faults

4.2. Results of frequency response of T2 winding at various values of shorting resistance

In this experiment only the T2 winding was tested. One turn from the layer 1 (smallest average radius) has been shorted. The value of resistance of the turn to be shorted is equal to 3.2 m Ω . Discrete values of the shorting resistance in the range of 0.085 m Ω to 390 Ω were applied. The results of FRA magnitude response $A(f)$ for discrete set of shorting resistance values $R_z[\Omega] \in \{0.013; 47\}$ are shown in figure 6. To show results clearly in the whole range of applied frequency only two frequency responses at various values of the shorting resistance are presented.

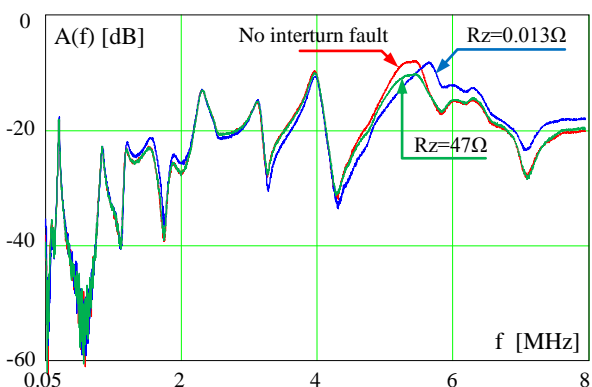

Fig. 6. Results of FRA magnitude response of the T2 winding without interturn fault and at two values of the shorting resistance R_z

Figure 7 shows the results of FRA magnitude response $A(f)$ for wider discrete set of shorting resistance values $R_z[\Omega] \in \{0.013; 1.2; 47; 390\}$. To show clearly differences in results the frequency f range is restricted.

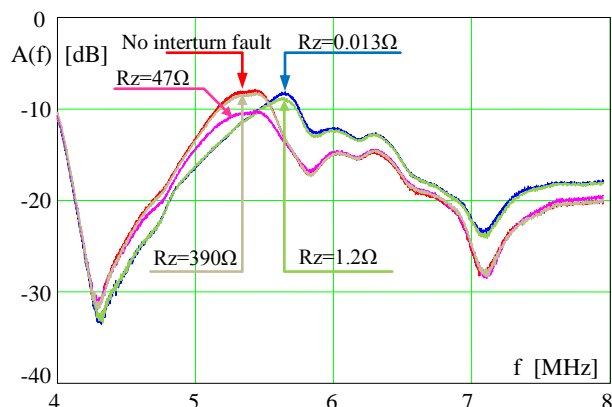

Fig. 7. Results of FRA magnitude response of the T2 winding without interturn fault for four values of the shorting resistance R_z . The ranges of amplitude and frequency are restricted to show results clearly

4.3. Results of frequency response of T2 winding at various locations of shorting resistance

In this experiment only the T2 winding was tested. Single turn coils at various locations (layer 1, 3, and 5) were shorted by means of the shorting resistance $R_z=0.085$ m Ω . The results of $A(f)$ in the whole range of applied frequency are shown in figure 8. The same results in the restricted range of frequency to show differences in results clearly are shown in figure 9.

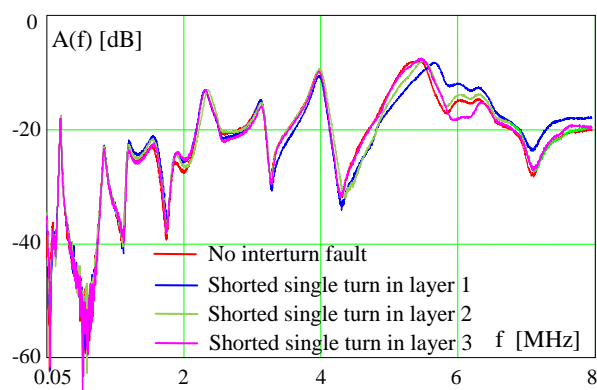

Fig. 8. Results of FRA amplitude response of the T2 winding at various locations (layer 1, 3, and 5) of the shorting resistance $R_z=0.085$ m Ω

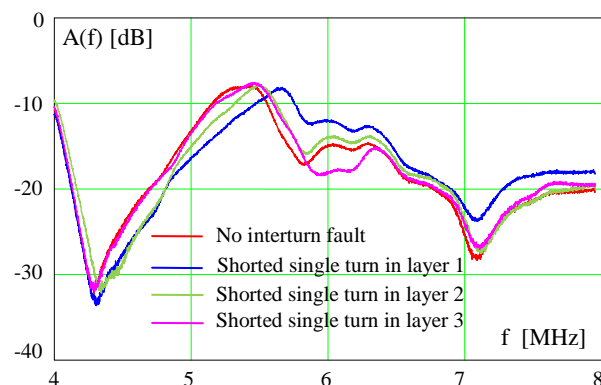

Fig. 9. Results of FRA amplitude response of the T2 winding at various locations (layer 1, 3, and 5) of the shorting resistance $R_z=0.085$ m Ω . The ranges of amplitude and frequency are restricted to show results clearly

5. DISCUSSION OF EXPERIMENTAL RESULTS

The T1 and T2 windings are located on different columns of the RSTT iron core. They are symmetrical regarding the type of construction and the number of turns. Comparison of the FRA amplitude results of the T1 and T2 windings without interturn faults shows that their frequency responses differ significantly. This results from technology used to manufacture windings. All windings were hand-made directly on columns of the iron core of the RSTT. No coil former was used for winding process. As a result, some differences in geometry of symmetrical windings appear. Some capacitances between turns and between layers differ and FRA responses are altered accordingly. These results show that FRA frequency response is very sensitive not only to mechanical displacements, but also to deformations of particular coils (turns and layers) in the winding. It can be concluded from this fact that each winding should have its reference frequency response (reference fingerprint) for no fault condition. This is important if symmetrical winding comparison and sister unit comparison cannot be used.

Experimental FRA amplitude response is influenced by shorted turns, but only for some ranges of values of shorting resistance. Figure 6 shows detectable changes in frequency response in the frequency range above 4.5MHz. If the value of R_z doesn't exceed few Ohms the frequency response shows a shift of some resonant frequencies and also the amplitude values at some resonant frequencies are altered. If the R_z increases to the value of tens Ohms there is no shift in frequency response, but amplitudes at some resonant frequencies are altered. If the shorting resistance R_z has the value of hundreds Ohms and higher it is not possible to detect such a case in the RSTT. The average value of a single turn is about 3 m Ω (for low frequency). From the presented results it can be concluded that detection of an interturn fault is possible for the shorting resistance R_z having the upper limit value ten thousand times higher than the value of resistance of a single turn to be shorted. Experimental FRA amplitude responses are also influenced by location of shorted turns. Shifts of some resonant frequencies and changes of amplitude values at other resonant frequencies have been observed.

Although FRA is a powerful diagnostic method, there are difficulties in result interpretation. Reliable analysis requires the reference fingerprints and experts to interpret results. Number of numerical evaluation techniques have been developed [7] for interpreting the frequency response, but description of them is outside the scope of the paper.

6. CONCLUSIONS

FRA carried out on symmetrical but handmade windings gives different frequency responses. This results from technology used to manufacture windings. The distributed capacitances in particular windings are different and this fact results in shifts of resonant and anti-resonant frequencies. FRA amplitude response is influenced by shorted turns, but only for some ranges of values of shorting resistance. It can be concluded that detection of an interturn fault is possible for shorting resistance having the upper limit value ten thousand times higher than the value of resistance of a single turn to be shorted. FRA magnitude spectrum also changes with respect to localization of short-circuited turns. The frequency responses showed shifts in case of some resonant frequencies for such faults.

7. REFERENCES

1. Dick E.P., Erven C.C.: Transformer diagnostic testing by frequency response analysis, IEEE Transactions on Power Appl. Systems, vol. PAS-97, No-6, Nov. 1978, pp. 2144-2153.
2. Ryder S.A.: Diagnosing transformer faults using frequency response analysis, IEEE Electrical Insulation magazine, vol. 19, No. 2, pp. 16-22, March/April 2003.
3. Islam S.: Detection of shorted turns and winding movements in large power transformers using frequency response analysis, IEEE PES winter meeting, vol. 3, pp. 2233-2238, Jan. 2327, 2000, Singapore.
4. Jayasinghe S.B., Wang Z.D., Jarman P.N., Darwin A.W.: Investigations on sensitivity of FRA technique in diagnosis of transformer winding deformations, IEEE International Symposium on Electrical Insulation, Indianapolis USA, Sept. 19-22, 2004.
5. Coffen L., Hildreth J.: A new development in power transformer frequency response analysis to determine winding deformation without the need for comparison to historical data, Proc. of the 2002 EPRI Substation Equipment Diagnostics Conference X, Feb. 17-20, San Antonio, 2002.
6. Wilk A.: Nonlinear modeling of traction transformer with coiled iron core for dynamic simulation, Zesz. Nauk. Wydziału Elektrotechniki i Automatyki Politechniki Gdańskiej, Nr 26, s.125-128, Gdańsk, 2009, ISSN 1425-5766.
7. Nirgude P.M., Ashokraju D., Rajkumar A.D., Singh B.P.: Application of numerical evaluation techniques for interpreting frequency response measurements in power transformers, IET Sci. Meas. Technol., 2008, Vol. 2, No. 5, pp. 275-285.

BADANIA EKSPERYMENTALNE ZWARĆ ZWOJOWYCH W UZWOJENIU TRANSFORMATORA Z WYKORZYSTANIEM METODY ANALIZY ODPOWIEDZI W DZIEDZINIE CZĘSTOTLIWOŚCI

Słowa kluczowe: Transformator trakcyjny, Zwarcie zwojowe, Analiza odpowiedzi w dziedzinie częstotliwości

W referacie przedstawiono wyniki badań eksperymentalnych specjalnego Transformatora Trakcyjnego o Zredukowanej Skali (TTZS) z wykorzystaniem metody analizy odpowiedzi w dziedzinie częstotliwości. Pokazano wybrane wyniki analizy FRA nieuszkodzonych symetrycznych uzwojeń strony wtórnej. Zmierzono widmo amplitudowe w przypadku zwarć zwojowych pojedynczych zwojów niektórych cewek. Wykazano, że miejsce wystąpienia zwarcia zwojowego ma wpływ na zmianę widma amplitudowego. Dodatkowo przeanalizowano wrażliwość metody FRA w zależności od wartości rezystancji zwierającej zwój cewki i podano, w jakim zakresie tej wartości możliwa jest detekcja zwarcia zwoju.