

RESEARCH ON THE EXISTENCE OF BORON NITRIDE EXISTENCE IN GREASE AND HOW IT INFLUENCES THE MOTION RESISTANCE OF THE STUD OF STEERING ROD

KRZYSZTOF SICZEK¹, PIOTR JÓŹWIAK²

Technical University of Lodz

Summary

The design of the steering rod pin for research vehicles has been presented in the article. The aim of described research has been the estimation of values for the coefficient of friction between sphere surfaces of the stud and of its seat, for two cases of grease. A road test has been carried out to estimate the number of relative displacements of the surfaces of the pin and its seat, in the measuring length. The model of the pin – seat assembly has been elaborated using a finite elements method. The unit loading on the pin surface has been calculated in the model. Additionally, the scheme of the research stand for the measurement of friction moment, between mating spherical surfaces of pin and its seat, in reversing motion conditions has been presented. Research on friction moment values between surfaces of the pin and its seat have been made in the stand, for the case of pure lithium grease existence and for the case of lithium grease with the boron nitride additive. Based on calculated unit pressure loading the spherical surface of the pin and on values of measured friction moment, values of friction coefficient between mating surface of the pin and its seat have been estimated. It has been noted a nonlinear dependence of the friction coefficient against the slip speed and hysteresis phenomena.

Keywords: pin of steering rod, friction moment, lithium grease, boron nitride

Index determinations

A – steering rack–body translational joint, *B* – body - strut spherical joint, *C* – steering tie rod–strut–knuckle spherical joint, *D* – steering rod–steering rack spherical joint, *K* – knuckle, *M* – damper tube, *O'* – wishbone–strut–knuckle spherical joint, *R*₁ – bushing, *R*₂ – bushing, *S* – strut, *W* – wishbone

¹ Technical University of Lodz, Department of Vehicles and Fundamentals of Machine Design, 116 Żeromskiego Street, 90-924 Lodz, e-mail: ks670907@p.lodz.pl, ph. +48 42 631 22 50

² Technical University of Lodz, Department of Vehicles and Fundamentals of Machine Design, 116 Żeromskiego 116 Street, 90-924 Lodz, e-mail: piotr.jozwiak@p.lodz.pl, ph. +48 42 631 22 53

1. Introduction

The McPherson suspension is the system currently employed in many small and medium-sized cars. Its common configuration (Fig. 1) consists of a strut (S) rigidly connected to the wheel support, or knuckle (K). The upper part of the strut is joined to the body (B) by means of a flexible union formed by an elastic element and a thrust ball bearing, which allows the rotation of strut [1].

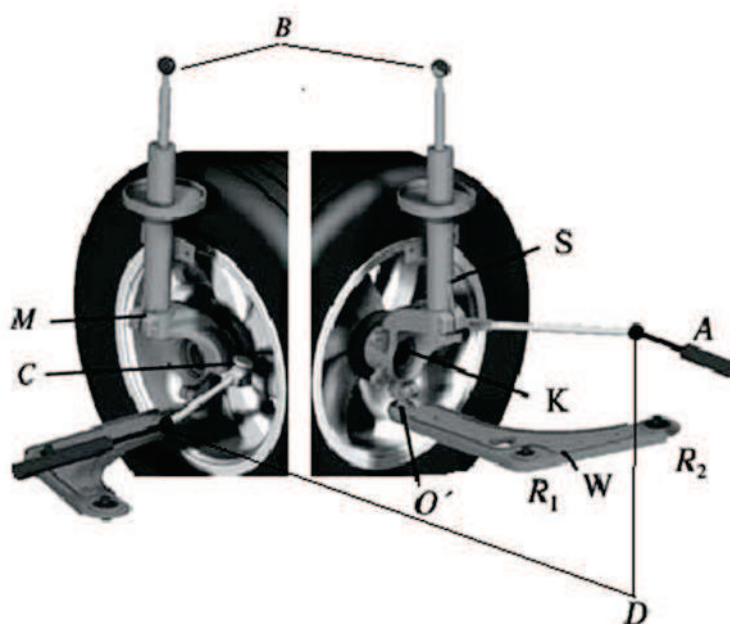

Fig. 1. The McPherson suspension elements for the right front wheel. A - steering rack-body translational joint, B - body - strut spherical joint, C - steering tie rod-strut-knuckle spherical joint, D - steering rod-steering rack spherical joint, K - knuckle, M - damper tube, O' - wishbone-strut-knuckle spherical joint, R₁ - bushing, R₂ - bushing, S - strut, W - wishbone

In the lower part of the suspension there is a wishbone (W), which joins the knuckle to the body. The union between the knuckle and the wishbone is made via a spherical joint (O'), the wishbone being connected to the body by means of two bushings (R₁ and R₂) which allow the relative rotation between both elements.

In order to transmit the turn of the steering wheel to the wheel, the tie rod is connected to the knuckle or the damper also by means of a spherical joint (Fig. 1).

As shown in Figure 2, the ball joint assembly includes a stud 1 with a ball 2 at its distal end. The ball is embedded in grease 3, within the socket 4, which may be integral with the stabilizer bar link. An elastomeric boot 5 is secured by lower and upper clamping rings 6, 7 to seal the socket 4.

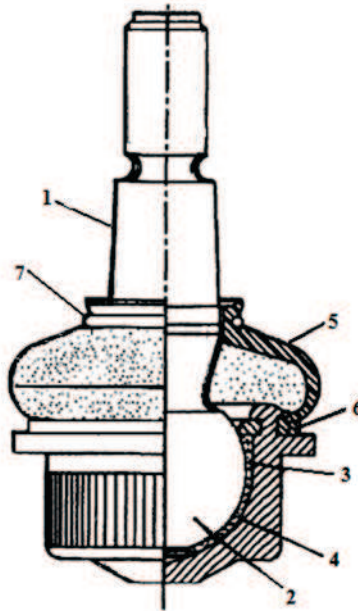

Fig. 2. The ball joint assembly. 1 - stud, 2 - ball, 3 - grease, 4 - socket, 5 - elastomeric boot, 6, 7 - lower and upper clamping rings

2. Operational conditions for analyzed stud of steering rod

The ball joint can be manufactured using an AISI-SAE 5140 steel. At it has been revealed in [2] the microstructure of the ball has been formed mainly by tempered martensite with acicular grains of ferrite on the grain boundaries. Such presence of tempered martensite indicates that the material endured a heat treatment of quenching and tempering. This has resulted in the beneficial effect of increasing material toughness of acicular ferrite in low carbon steels [3-5]. Additionally the acicular ferrite can decrease the fracture toughness and mechanical strength of heat treated steels when it appears on tempered martensite grain boundaries [6, 7].

The presence of acicular ferrite on grain boundaries can also induce a localized reduction on the hardness of the material, which results in a reduction of the fatigue endurance limit. This, along with the reduction on toughness can strongly reduce the life of the component.

According to Murakami [8], the uniaxial fatigue strength σ_f can be related with the Vickers hardness H_v as:

$$\sigma_f = 1.6H_v \pm 0.1H_v \quad (1)$$

The measured bulk Vickers hardness of the failed element was of 353 Hv. Therefore, using Eq. (1), the uniaxial fatigue strength

of the material can be estimated as $565 \text{ MPa} \pm 35.3 \text{ MPa}$. Alsaran et al. [9, 10] researched the effect of heat treatment on the properties of AISI-SAE 5140 steel used in the manufacture of suspension system ball joints, finding a fatigue endurance limit of 416 MPa. As Alsaran's endurance limit is lower than the value found using Eq. (1), this value is then used as the bulk fatigue endurance limit of the analyzed ball joint element.

The Vickers microhardness of the acicular ferrite on the tempered martensite grain boundaries was also measured, finding a mean value of 204 Hv. Using Eq. (1), the endurance limit for the acicular ferrite approximates to $326 \text{ MPa} \pm 20.4 \text{ MPa}$. Despite the differences found on the endurance limit of the material by using Murakami's or Alsaran's approaches, it is evident that acicular ferrite reduces the endurance limit of the material in approximately 40%. This reduction on endurance limit is considered to be the cause of the fatigue crack initiation on the element, which was further enhanced by the contact stresses highlighted by the ratchet marks present on the fracture surface.

Loading for the stud of steering rod can approach up to 500 N [2, 11].

Angular displacements of stud ball surface in respect to its seat have not been greater than 15° . Angular velocities for such displacements have not been so high and they have been highly dependent to driver reactions.

In order to obtain estimated values of displacements for spherical surfaces of steering rod studs and of their seats, this was keenly observed during steering displacements during driving OPEL VECTRA B 1997.

When driving a measuring length of 1300 m, with the mean speed equal 40 kph, it has been done 67 steering displacements took place, what is compatible with 67 displacements in spherical joints of steering rods. Such displacements were due to the roughness passing necessity. Observed angular displacements of steering wheel have been equal $30 - 100^\circ$, making in time up to 1 s. Taking into considerations the maximum ratio gear rack steering gear, equal 16.5:1 [12], it has corresponded to angular displacements of spherical surfaces in ball joints equal $1.8^\circ - 6^\circ$. Of course, at larger angles the steering gear ratio is a bit smaller, which increases the angular movement of mentioned spherical surfaces.

The averaged velocity for relative motion of mating spherical surfaces on the stud and its seat can be estimated from equation (2):

$$v_a = \frac{\sqrt{2}}{2} \omega_{\max} \cdot \frac{2R}{\pi} \quad (2)$$

where: R – radius of stud spherical part, ω_{\max} – maximal angular velocity of the stud relative to its seat.

Estimated values of maximal angular velocity ω_{\max} have been equal from 0.032 – 0.105 rd/s. It has corresponded to values of average relative velocity v_a equal 0.00019 – 0.00063 m/s.

3. The aim of the study and means used to reduce the resistance to motion for the contact of stud with its seat

The aim of the research discussed in the article has been to determine the value of the coefficient of friction between the spherical surfaces of the stud and seat for the two types of lubricants.

In the case of greases including lithium one, it has been used in some special cases, as a means of antiseizure and seal: graphite [13], molybdenum disulfide [14], boron nitride [15-17], metal powders, and more. The grease keeps solid particles in suspension. The finely ground, solid lubricants such as molybdenum disulfide and graphite are mixed with the grease at a high temperature or at a very high pressure [18].

An example of grease with molybdenum disulfide is Vecolit MOS elaborated for chassis lubrication mechanisms vehicles and industrial equipment, operating under shock loads, vibration and dust. It is intended for operation in the temperature range from -50 to 140 °C. It is recommended for lubrication of constant velocity joints vehicles [19].

An example of grease with graphite is graphite Vecocal, elaborated for vehicle chassis lubrication mechanisms and mechanisms of low precision performance (mixer gear, helical gear, guides) operating under typical operating conditions. It can be used as a grease fitting for easy assembly and disassembly of threaded connections again and pins. It is designed for operation in the temperature range from -30 to 60 °C [19].

For the grease it is applied the thermodynamically stable boron nitride, which under normal conditions is the hexagonal phase (α -BN), with a strength similar to that of graphite. It can be obtained using combustion synthesis by decomposition of $N_2H_5BH_4$ [20].

Boron nitride is referred to as "white graphite" which is a solid lubricant material, of the plate hexagonal structure like graphite. Unlike graphite it is a good insulator. It has a very high thermal conductivity and high resistance to thermal shock. It is stable in inert or reducing atmosphere up to 2800 °C, in an oxidizing atmosphere up to 850° C [21].

According to the patent [22], for a plastic grease basis with high purity and low softening point and dropping point it is recommended to implement the finely ground boron nitride (BN- α) in an amount up to 10% by weight during mixing process with the mentioned basis. In the impregnation of the grease into porous bearing, made of sintered powder of iron or brass, with a porosity of 20 - 30%, α -BN is most preferably used in an amount of 5% by weight [22].

Boron nitride does not substantially affect the rheological properties of lithium grease.

During the study of conical roller bearings No. 30 209, of main dimensions 45x85x19 mm at a load of $P = 1820$ N and $n = 1700$ rpm it has been obtained twice less friction force for LH43 lubricated with 2% by weight of boron nitride as compared with the pure lubricant [22].

On the other hand, during the tests of self-starter porous bearings made of sintered bronze powder and impregnated by lithium grease filled with boron nitride in an amount of 1 - 10%

by weight, it has been found the reduction of the friction torque for a nitride content of 2 - 4% by weight, in respect to the case of the pure grease [23].

In [24] it has been presented the results of research for resistant to low temperature greases, developed on the basis of a mixture of synthetic olefin and dioctyl sebacate and concentrated by modified silica - for cases of pure grease and of one with the addition of boron nitride. It has been found that the boron nitride used in a concentration of 2%, 4%, 8% deteriorated antiwear properties of developed grease and not influence its antiseizure properties.

4. Research stand for measurement of friction moment between spherical surfaces of stud and its seat

One of the aforementioned original studs of steering rod has been studied in the research stand allowing us to obtain values of friction moment between the stud ball and its seat. The photograph of the research stand, owned by Department of Vehicles and Fundamentals of Machine Design at the Technical University of Lodz, has been presented in the figure 3.

The stud of steering rod with its seat has been researched. The diameter for the spherical part of the stud was 27 mm. Fixed stud has been loaded by constant force equal to 7 N. The seat has made reverse displacements with the constant frequency equal 36 Hz.

Two measuring series were made:

- for the stud ball mating with its seat in lubrication conditions of original lithium grease,

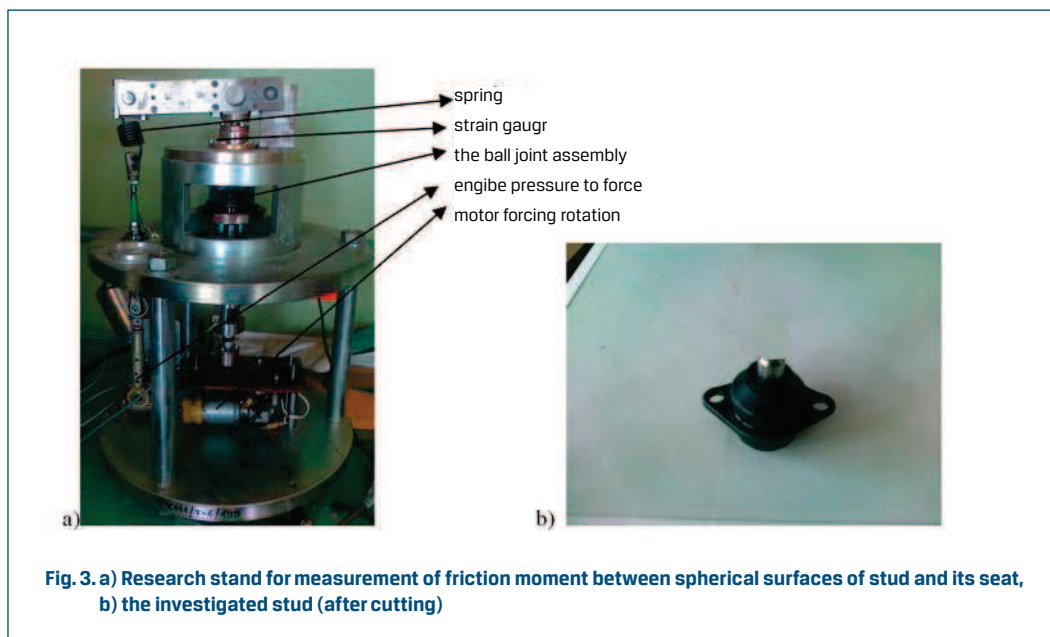

Fig. 3. a) Research stand for measurement of friction moment between spherical surfaces of stud and its seat, b) the investigated stud (after cutting)

- for the stud ball mating with its seat in lubrication conditions of lithium grease with 4% BN additive.

5. Model for the stud of steering rod

The model for the stud of the steering rod has been made using FEM and has been presented in the figure 4. The model has consisted of the stud 1, seat 2, grease 3 and bushing 4. A finite elements mesh has been generated automatically by commercial program ANSYS [13]. Boundary conditions, presented in the figure 5, followed. The bushing has been fixed on its outer cylindrical surface. In the case to corresponding real loading conditions (fig. 5A), the stud has been supported in place a on the cylindrical surface sector with the length equal 3 mm and with the height equal 1 mm. The stud has been loaded by a radial force equal 500 N. Such value has been assumed based on literature data [2, 11].

In the case corresponding test conditions (fig. 5B), the stud has been loaded by axial force equal 7 N, as the force loading tester.

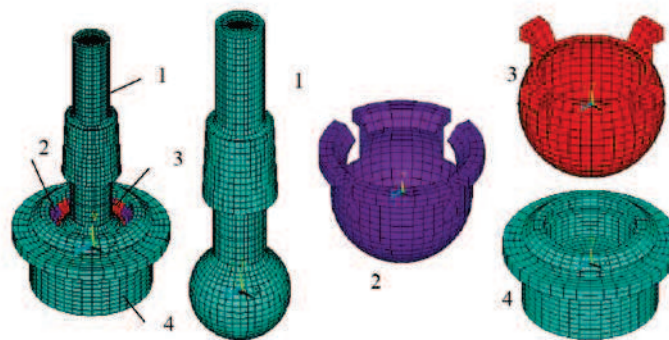

Fig. 4. Finite element mesh for model of , 1 - stud, 2 - seat, 3 - grease, 4 - bushing

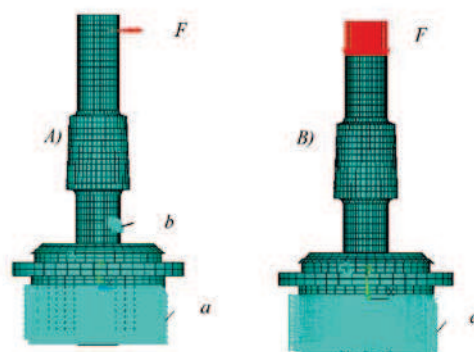

Fig. 5. Boundary conditions in the model for the stud of steering rod; A) loading by radial force F , B) loading by axial force F ; a - fixed outer cylindrical surface of bushing, b - stud support in the cylindrical surface sector, F - loading of the stud

6. Results of measurements

As a result of the measurements carried out in the research stand the courses of friction moment vs. time for the case of ball joints lubricated by original grease and by grease with BN additive have been obtained. Obtained values of the measured friction model vs. time have been shown in the Figure 6a. Zoom of the part view 1 and 2 have been shown in the Figures 6b and 6c respectively. The absolute values of the moment have not been greater than 2.5 Nm.

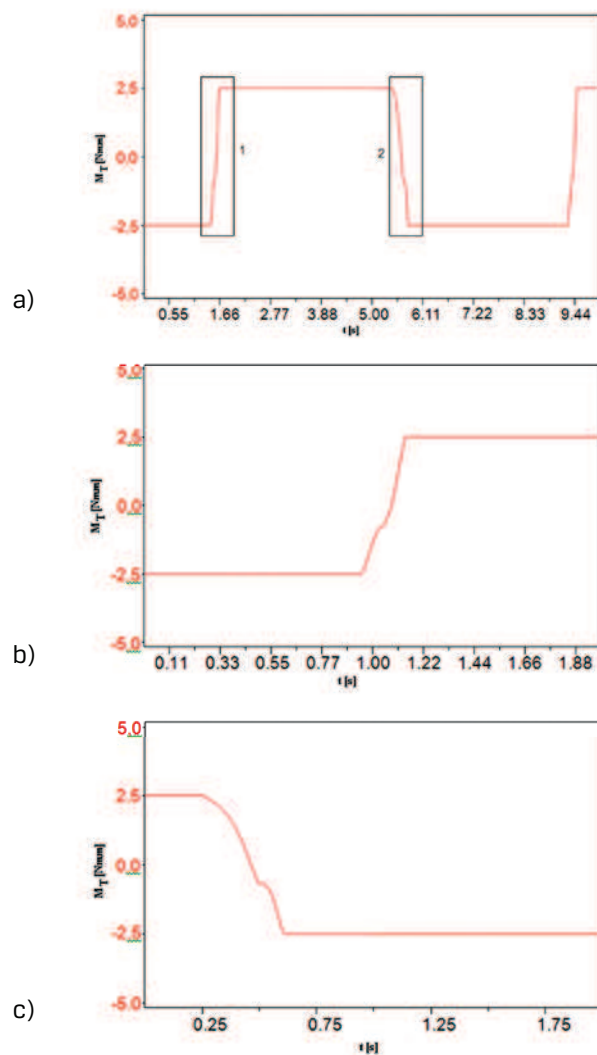

Fig. 6. a) Friction moment vs. time, frequency of the reversible motion 36 Hz, b) zoom of part view 1, c) zoom of part view 2; the steel - steel contact case

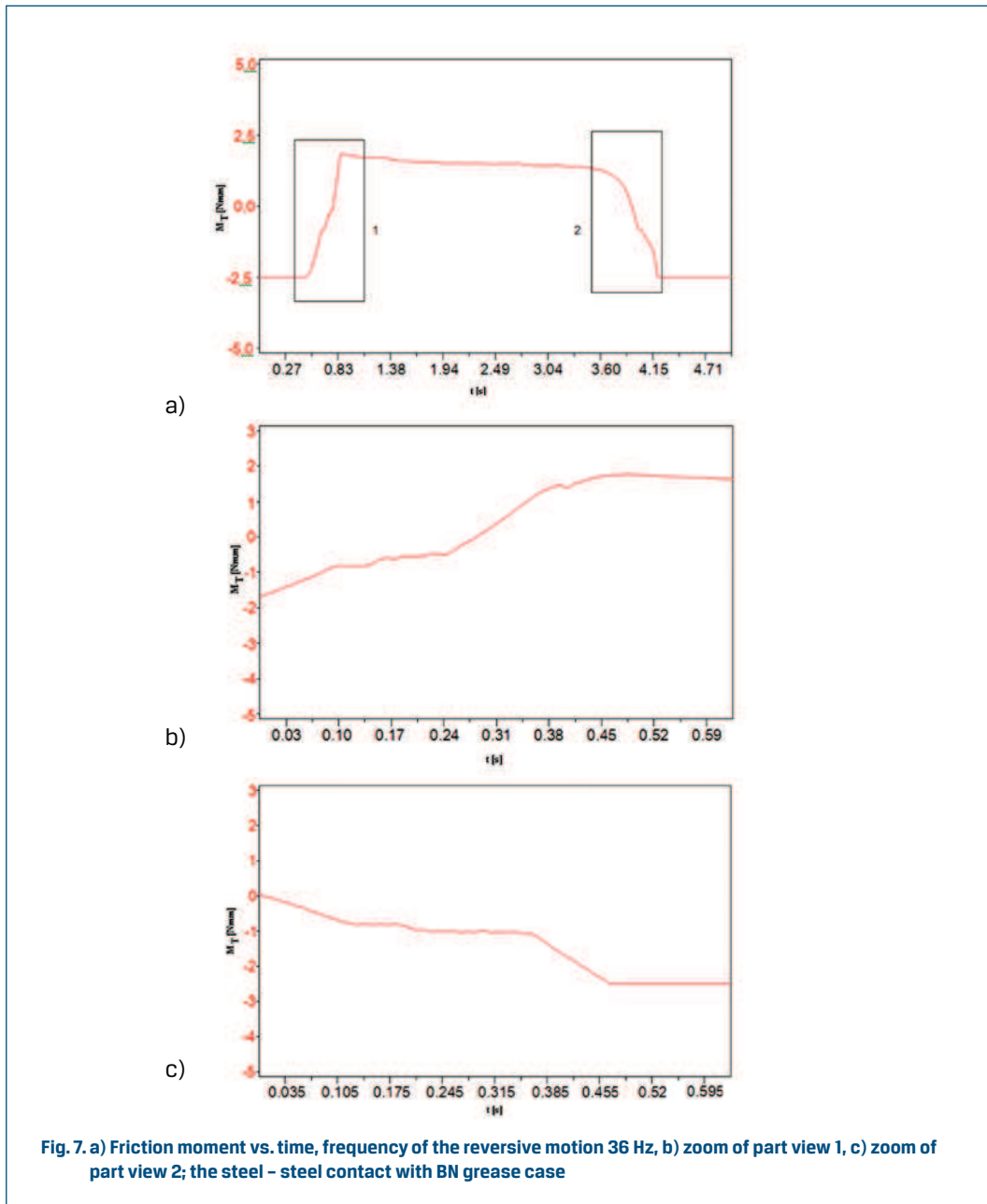

Fig. 7. a) Friction moment vs. time, frequency of the reversible motion 36 Hz, b) zoom of part view 1, c) zoom of part view 2; the steel - steel contact with BN grease case

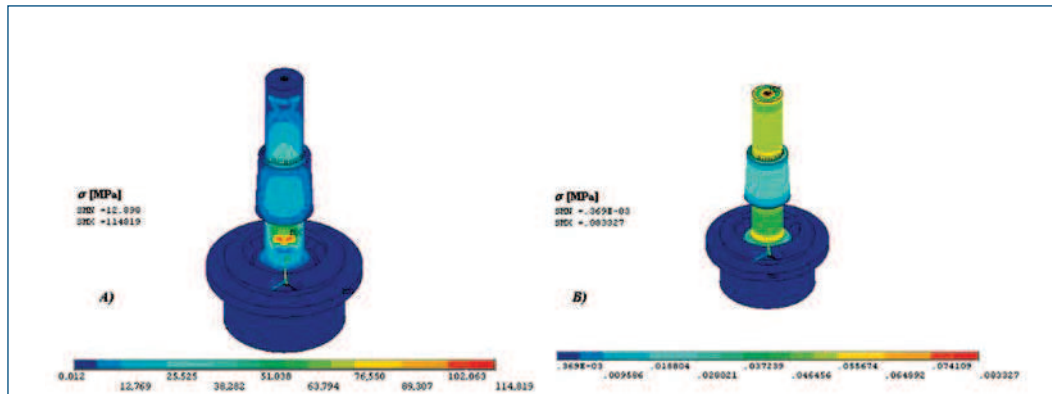

Fig. 8. von Mises stresses in the model for the stud of steering rod; A - loading by radial force $F = 500$ N, B - loading by axial force $F = 7$ N

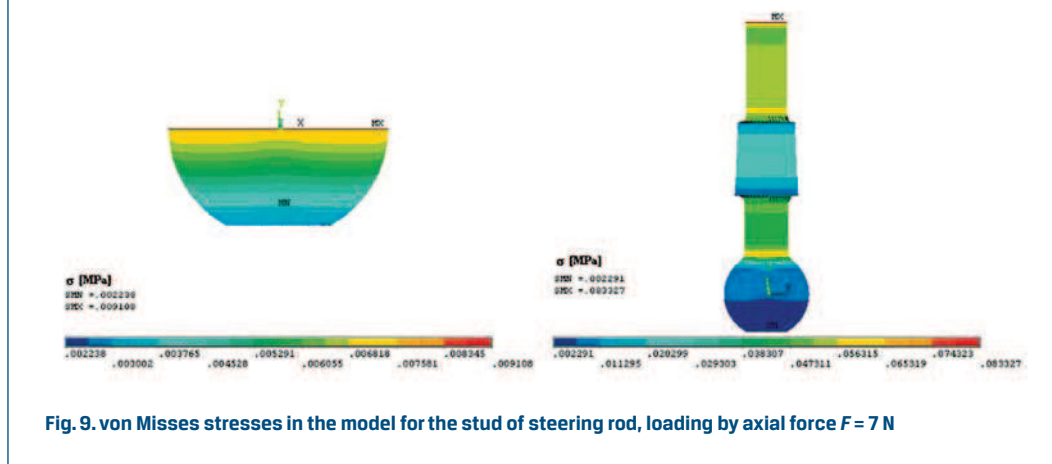

Fig. 9. von Mises stresses in the model for the stud of steering rod, loading by axial force $F = 7$ N

During loading the stud by radial force $F = 500$ N, averaged von Mises stresses in contact zone have been equal 0.87 MPa.

During loading the stud by axial force $F = 7$ N, averaged von Mises stresses in contact zone have been equal 0.00393 MPa, maximal von Mises stresses in contact zone have been equal 0.008 MPa.

Values of friction coefficient can be calculated from equation (3):

$$\mu = \frac{M_T}{2 \cdot \pi \cdot \sigma \cdot \frac{2}{3} \cdot R^3} \quad (3)$$

where: M_T - friction force, σ - averaged von Mises stress in contact zone

The calculated value of friction coefficient, for lithium grease, has been equal to 0.062. The value, for lithium grease with addition of 4% BN, valued from 0.031 to 0.045. With the addition of 4% BN into the lithium grease, friction force has decreased about 27 – 50%.

The power P_T , need to overloading such a moment can be estimated from the equation (4):

$$P_T = M_T \cdot \frac{\sqrt{2}}{2} \cdot \omega_{\max} \quad (4)$$

During loading of stud by radial force $F = 500$ N, there exist the friction moment with the value of 553 Nmm, in the contact between spherical surfaces of stud and of its seat, lubricated by lithium grease.

To overcome such a moment the power P_T is needed, which is calculated from the equation (4) and equal 0.012 – 0.041 W.

Also it is interesting the change in the coefficient of friction as a function of the average peripheral speed. For approximate analysis it has been assumed that the time course of changes in the relative friction in the contact against the relative angular velocity is similar to the time course of changes in the relative friction against the relative slip angular velocity for the friction clutch case, obtained from rotational LuGre model (Fig. 10) [26]. The relationship is nearly linear. To simplify the analysis it has been omitted the stick-slip phenomena, but due to the relatively low frequency of excitations (0.12 Hz) they can generate cyclical changes in the friction force / torque by up to 10%, the rate of at least an order greater than the frequency of excitation, as indicated in [26, 27].

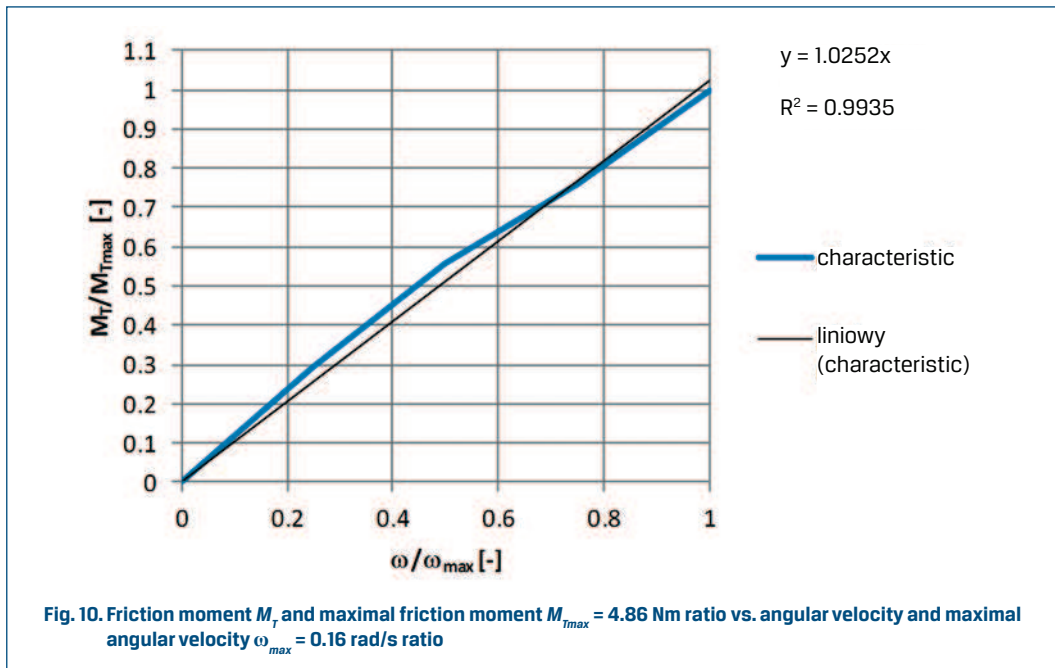

In addition, it has been developed a chart for the slip speed of the investigated stud relative to its seat as a function of time (Fig. 11), basing on the data in [28]. Based on such chart and on the equation (2) it has been calculated changes in time course of the average slip speed in the tested stud against the time. 12). On the basis of the time courses for the speed and the friction torque and of equation (3) it has been obtained charts of friction coefficient against sliding velocity for three cases: pure lithium grease (Fig. 13), lithium grease with the addition of 4% boron nitride (Fig. 14) and the friction torque obtained from the rotational LuGre model (Fig. 15) [26].

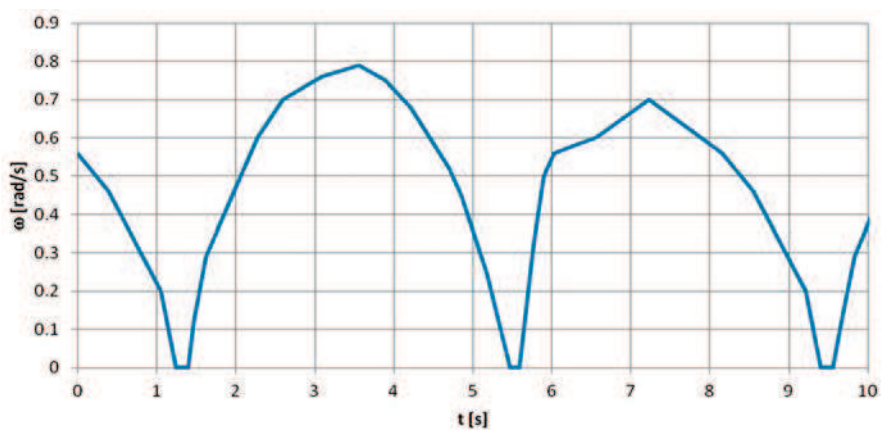

Fig. 11. The absolute value of angular velocity ω vs. time t

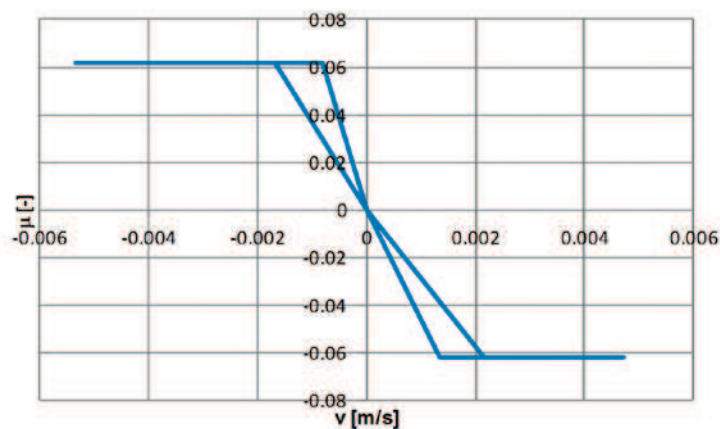

Fig. 12. Friction coefficient μ in the contact zone of the investigated stud and its seat vs. angular velocity ω , for the case of the pure lithium grease

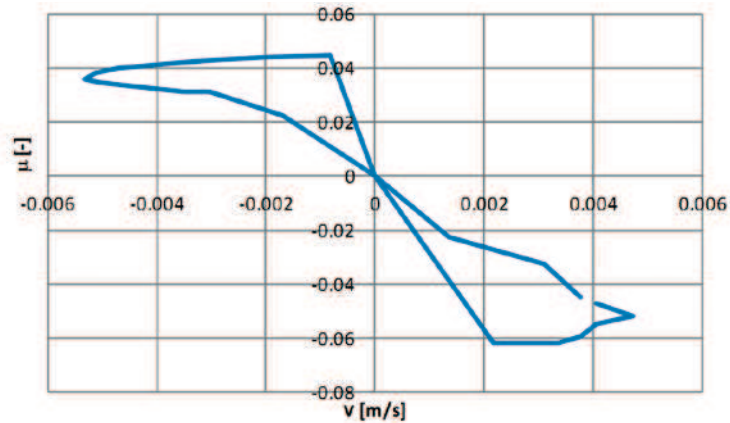

Fig. 13. Friction coefficient μ in the contact zone of the investigated stud and its seat vs. angular velocity ω , for the case of the lithium grease with addition of 4% BN

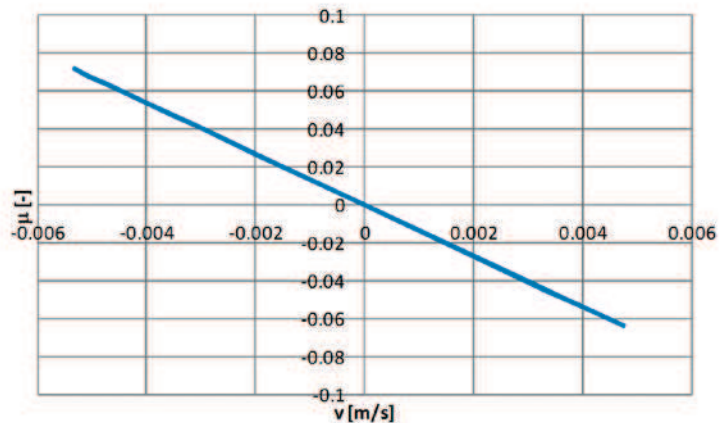

Fig. 14. Friction coefficient μ in the contact zone of the investigated stud and its seat vs. angular velocity ω , for the case of the moment calculated from LuGre rotational model.

The differences in the time courses of the angular velocity ω vs. time t have been due to differences in the tester stiffness at different rotation directions of the seat relative to the stud.

Dependence of the friction coefficient on the slip angular velocity shows nonlinearity (Fig. 10, 12-13), and hysteresis phenomena have occurred (Figures 13 and 14). The nature of the hysteresis for the case of pure lithium grease has been definitely different from the lithium grease with the addition of 4% boron nitride. The negative values of the coefficient of

friction and the rotational speed have occurred due to rotation. Almost linear dependence of friction coefficient on slip velocity, obtained from the rotational LuGre model only roughly reflects changes in time course for the coefficient of friction against slip speed.

7. Conclusions

1. Averaged values of stress in contact zone for spherical surfaces the stud and its seat are smaller about 50% than the maximal values.
2. Averaged values of the relative velocity in contact zone for spherical surfaces the stud and its seat are smaller about 22 % than the maximal values.
3. Additive of 4% BN into pure lithium grease has decreased friction force about 27 – 50% in respect to pure lithium grease.
4. There is non-linear dependence of the friction coefficient against slip velocity in the contact zone for the investigated stud and its seat lubricated with lithium grease. Hysteresis phenomena are present, the nature of which is changed after the addition of α -BN.

References

- [1] REIMPELL J., STOLL H.: *The Automotive Chassis: Engineering Principles*, Ed. Arnold, London, 1998.
- [2] OSSA E.A., PALACIO C.C., PANIAGUA M.A.: *Failure analysis of a car suspension system ball joint*, Engineering Failure Analysis 18 (2011), pp. 1388–1394
- [3] HE K., EDMONDS D.V.: *Formation of acicular ferrite and influence of vanadium alloying*. Mater Sci Technol 2002;18:289–96.
- [4] BOL'SHAKOV V.I., LAUKHIN D.V., SUKHOMLIN G.D., KUKSENKO V.I.: *Effect of heat treatment on formation of acicular ferrite and on the properties of low carbon microalloyed steels 10G2FB and 09G2S*. Met Sci Heat Treat 2004;46(11–12):545–50.
- [5] MAZANCOVA E., RUCKA Z., MAZANEC K.: *Comparison of microfractographic behaviour of acicular ferrite and bainite and hydrogen cracking resistance*. Arch. Mater Sci 2007;28(1–4):95–9.
- [6] HUANG Z., YAO M.: *Effect of arrangement of acicular ferrite in a Widmanstätten microstructure on the fracture of mild steel*. Mater Sci Eng: A 1989;119:211–7.
- [7] OSSA E.A., PANIAGUA M.: *Failure analysis of a fastener system and its analytical prediction*, SAMPE conference, Baltimore, MD, USA. 2009.
- [8] MURAKAMI Y.: *Metal fatigue: effects of small defects and non-metallic inclusions*. Elsevier; 2002.
- [9] ALSARAN A., KARAKAN M., CELIK A.: *The investigation of mechanical properties of ion-nitrided AISI 5140 low-alloy steel Materials Characterization*. Mater Charact 2002;48:323–7.
- [10] BAYRAK M., OZTURK F., DEMIREZEN M., EVIS Z.: *Analysis of tempering treatment on material properties of DIN 41Cr4 and DIN 42CrMo4 steels*. J Mater Eng Perform 2007;16(5):597–600.
- [11] RYU Y.I., KANG D.O., HEO S.J., YIM H.J., JEON J.I.: *Development of analytical process to reduce side load in strut-type suspension*. J Mech Sci Technol 2010;24:351–6.
- [12] <http://forum.vectraklub.pl/index.php/topic/38770-x16xel-dane-techniczne-i-parametry/>
- [13] YOSHII Y., HIRAOKA N., SASAKI A., NODOMI Y., KENMOCHI N., 1997. *The influence of atmosphere on the life of solid lubricated ball bearings*. Proc. 1 st World Tribology Congress. Mechanical Engineering Publications Ltd. London, 74.

- [14] KAKIZAKI T., OKIZAKI Y., NISHIMURA M., 1999. *Improvement of tribological responses of sputtered MoS_x films by carbon ion implantation*. Proc. VII th Inter. Symp. INTERTRIBO'99. Stara Lesna (Slovakia). Dom Technika Bratislava. 3-B-348.
- [15] MRÓZ W., BUDNER B., CZWARTOS J., GOCMAN K., PROKOPIUK A., KAŁDOŃSKI T.: *Zastosowanie azotku boru jako materiału smarującego w porowatych łożyskach ślizgowych*, Inżynieria Materiałowa, nr 4(182), Warszawa, 2011
- [16] KAŁDOŃSKI T., KRZEMIŃSKI K., 1997. *Zastosowanie azotku boru jako dodatku do smaru plastycznego wypełniającego łożysko toczne*. Tribologia 5-6, 658-666. Bratislava, vol. A, 40-48.
- [17] KAŁDOŃSKI T.: *Tribologiczne zastosowania azotku boru*. Wojskowa Akademia Techniczna, Warszawa, 2006.
- [18] <http://www.machinerylubrication.com/Read/1352/grease-basics>
- [19] <http://www.modex.com.pl/>
- [20] BOROVINSKAYA I.P., BUNIN V. A., MERZHANOV A. G.: *Self-propagating high-temperature synthesis of high-porous boron nitride*. Mendeleev Communications., 1997, Issue 2, pp. 47-48
- [21] <http://accuratus.com/boron.html>
- [22] Patent PL 192006 B1
- [23] BURCAN J., SICZEK K.: *Badania wpływu warunków eksploatacyjnych na trwałość ponaprawczą łożysk na przykładzie układu łożyskowego rozrusznika*, sprawozdanie z projektu badawczego 7T07B00211, Politechnika Łódzka, 1998
- [24] BAJER J.: *Wpływ dodatku smarnego na charakterystyki tribologiczne niskotemperaturowego smaru plastycznego*. Tribologia, Nr 6, 2006, s. 67 -80
- [25] ANSYS v.12 help on-line documentation
- [26] ANDRZEJWSKI R.: *Dynamika pneumatycznego koła jezdneho*. Wydawnictwo Naukowo techniczne, Warszawa, 2010
- [27] GRUDZIŃSKI K., WARDA B.J., ZAPŁATA M.: *Badania pary ślizgowej jako układu o dwóch stopniach swobody*. Tribologia, 1996, t. 27, nr 5, s. 631-651
- [28] BURCAN J., WITOSŁAWSKI P.: *Badania oporów tarcia w endoprotezach stawu biodrowego*. materiały seminarium Warsztaty Tribologiczne. Biotribologia. Politechnika Łódzka. Łódź, marzec 2007, dostępne: <http://www.kkp.p.lodz.pl/PW.pdf>