

## Pressure drop during condensation of refrigerants in pipe minichannels

TADEUSZ BOHDAL\*  
HENRYK CHARUN  
MAŁGORZATA SIKORA

Koszalin University of Technology, Raclawicka 15-17, 75-620 Koszalin, Poland

**Abstract** The present paper describes results of experimental investigations of pressure drop during the condensation of R134a, R404a and R407C refrigerants in pipe minichannels with internal diameter 0.31–3.30 mm. The results concern investigations of the mean and local pressure drop in single minichannels. The results of experimental investigations were compared with the calculations according to the correlations proposed by other authors. A pressure drop during the condensation of refrigerants is described in a satisfactory manner with Friedel and Garimella correlations. On the basis of the experimental investigations, the authors proposed their own correlation for calculation of local pressure drop during condensation in single minichannels.

**Keywords:** Compact condenser; Condensation in minichannels; Pressure drop during flow in condensation

### Nomenclature

$d$	–	minichannel inner diameter, m
$d_h$	–	hydraulic diameter, m
$f$	–	friction coefficient
$G$	–	mass flux density, kg/m <sup>2</sup> s
$j_g$	–	dimensionless vapour velocity
$L$	–	length, m
$p$	–	pressure, kPa

---

\*Corresponding author. E-mail address: Tadeusz.Bohdal@tu.koszalin.pl

$\Delta p$	-	pressure drop, kPa
$T$	-	temperature, °C
$x$	-	quality
$q$	-	heat flux density, W/m <sup>2</sup>
We	-	We = $\frac{G^2 d}{\sigma \rho g}$ Weber number
Re	-	Reynolds number

### Greek symbols

$\Phi_f^2$	-	correction factor
$\rho$	-	density, kg/m <sup>3</sup>
$\mu$	-	dynamic viscosity, kg/ms
$\chi_{tt}$	-	dimensionless two-phase flow multiplier Martinelli
$\sigma$	-	surface tension, N/m

### Subscripts

$a$	-	averaging conditions
$A$	-	acceleration
$cr$	-	critical value
$exp$	-	experimental value
$f$	-	flow of one of the phases
$g$	-	gas
$g_o$	-	gas only
$H$	-	hydrostatic
$i$	-	following section $i$ ( $i = 1, 2, \dots, 9$ )
$l$	-	liquid
$l_o$	-	liquid only
$r$	-	reduced pressure
$s$	-	saturation value
$th$	-	theoretical value
$TP$	-	two phase
$TPF$	-	frictional
$x$	-	local value

## 1 Introduction

These days, many world centers deal with the construction and operation of compact refrigerating devices. This is in line with the expectations of the 21st century, i.e. aiming at the application of energy-saving and environmentally friendly devices. In the case of compressor refrigerating devices, the problem concerns above all the construction of compressors and heat exchangers. Heat exchangers (condensers and evaporators) should be designed in such a manner that with a small consumption of refrigerant medium, a large heat flux density could be transferred with a high energy efficiency. This means that the demand for refrigerant and driving energy to

move the refrigerant should be small, which is connected with the guarantee of small flow resistances in the system of exchanger channels [3].

This study presents the data for the assessment of the pressure drop in a two-phase flow of refrigerants R134a, R404A and R407C during condensation in pipe minichannels of compact condensers.

## 2 Review of literature

In the paper by Mehendale *et al.* [15], heat exchangers are classified according to the criterion of the hydraulic diameter: micro-exchangers ( $d_h = 1\text{--}100\ \mu\text{m}$ ), meso-exchangers ( $100\ \mu\text{m} \leq d_h \leq 1\ \text{mm}$ ), compact exchangers ( $d_h = 1\text{--}6\ \text{mm}$ ) and conventional exchangers ( $d_h > 6\ \text{mm}$ ). Kandlikar [12] proposed a different classification of channels that are used in exchangers: microchannels ( $d_h < 200\ \mu\text{m}$ ), minichannels ( $200\ \mu\text{m} \leq d_h \leq 3\ \text{mm}$ ) and conventional channels ( $d_h > 3\ \text{mm}$ ). Regardless of the discrepancies in the criteria given, it is to be found that channels with a small diameter are found in the range  $3\ \text{mm} \leq d_h \leq 6\ \text{mm}$ . This problem is important as the correlations recommended for calculations and which describe flow resistances concern conventional channels in particular. It is proven in many publications that one cannot unambiguously use those correlations which have been verified for conventional channels in relation to channels with small diameters, especially for those refrigerants which undergo phase changes (boiling or condensation) [6, 17].

It was demonstrated on the basis of theoretical and experimental analyses that the total local or average pressure drop in a two-phase flow can be presented in the following form:

$$\left(\frac{\Delta p}{L}\right)_{TP} = \left(\frac{\Delta p}{L}\right)_{TPF} + \left(\frac{\Delta p}{L}\right)_H + \left(\frac{\Delta p}{L}\right)_A, \quad (1)$$

where:

$$\left(\frac{\Delta p}{L}\right)_{TPF} \quad - \quad \text{frictional pressure drop}, \quad (2)$$

$$\left(\frac{\Delta p}{L}\right)_H \quad - \quad \text{hydrostatic pressure drop}, \quad (3)$$

$$\left(\frac{\Delta p}{L}\right)_A \quad - \quad \text{acceleration pressure drop}. \quad (4)$$

In the case of boiling and condensation of refrigerants in pipe minichannels, hydrostatic and acceleration pressure drops can be neglected, as their values are small (they are accepted to be equal to zero). Therefore, it is the frictional pressure drop which has the essential impact. Calculation methods based on homogenous and separated models are most frequently used for the purpose of its calculation. The homogenous model is very rarely used in the analysis of condensation in minichannels. Both for conventional channels and minichannels, the separated model is usually used with two calculation methods, i.e. Lockhardt-Martinelli method [14] or Friedel method [9]. It is assumed in the separated model that the total resistance of a two-phase flow is caused by an equivalent frictional resistance of the flow of one of the phases (a liquid or gaseous phase), which is expressed with the following dependence:

$$\left(\frac{\Delta p}{L}\right)_{TPF} = \left(\frac{\Delta p}{L}\right)_f \Phi_f^2, \quad (5)$$

where  $(\Delta p/L)_f$  is the pressure drop being the result of the flow of one of the phases ( $f$ ), while  $\Phi_f^2$  denotes the correction factor of a two-phase flow. In most cases, an analytical pressure drop is used in the liquid phase flow; then in Eq. (2)  $f = l, lo$ , and the correction factor accepts the following denotation:  $\Phi_f^2 = \Phi_{lo}^2$ .

Two-phase flow resistances of a refrigerant during condensation in channels with a small diameter depend from very many parameters. The most important of these parameters are as follows: hydraulic diameter  $d_h$ , refrigerant's mass flux density  $G$ , quality  $x$  and the refrigerant type. In the dependences which take into account the type of the refrigerant, the importance of the following properties is emphasized: reduced pressure  $p_r$  ( $p_r = p_s/p_{cr}$ ), where:  $p_s$  – saturation pressure; condensation pressure,  $p_{cr}$  – critical pressure of the refrigerant), dynamic viscosity coefficient  $\mu$ , density  $\rho$  and surface tension  $\sigma$ . The set of parameters given absolutely needs to be supplemented with information concerning the structure of the two-phase flow, which is described in particular with the following quantities:

Lockhardt-Martinelli parameter:

$$\chi_{tt} = \left(\frac{1-x}{x}\right)^{0.9} \left(\frac{\rho_g}{\rho_l}\right)^{0.5} \left(\frac{\mu_l}{\mu_g}\right)^{0.1}, \quad (6)$$

and the apparent velocity of one of the phases (e.g.  $j_g$  – gaseous phase):

$$j_g = \frac{Gx}{\sqrt{gd\rho_g(\rho_l - \rho_g)}}, \quad (7)$$

where  $g$  denotes gravitational acceleration. In the paper by the Coleman and Garimella [8] the values were given of Lockhardt-Martinelli parameters and velocity of the gaseous phase, which allow for an initial identification of the two-phase flow structures limits (for R134a in particular), Tab. 1.

Table 1. Criteria of the identification of the flow regimes by Coleman and Garimella [8].

Two-phase flow structure	$j_g$	$\chi_{tt}$
Annular film flow	$\geq 2.5$	–
Annular-stratified flow	$< 2.5$	$< 1.6$
Stratified wavy flow	$< 2.5$	$> 1.6$
Plug flow		

In the literature, there are no generalised maps of two-phase flow structures at present. Maps of this type are most frequently published for R134a refrigerant, while there is hardly any information for other new refrigerants. Figure 1 presents examples of maps of flow structures for R134a. In the

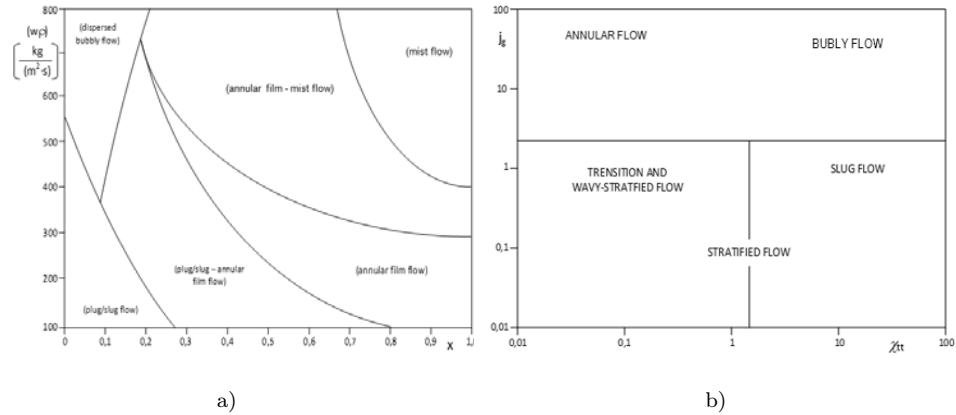

Figure 1. Maps of two-phase flow structures in the condensation process of R134a refrigerant in minichannels according to: a) Coleman and Garimella [8], b) Cavallini *et al.* [5].

thematic studies by Kandlikar *et al.* [13] and Ghiaasiaan [14], an analysis was performed of a dozen or so of correlations (proposed by various authors) for calculation of the R134a refrigerant flow resistance in the condensation process in pipe minichannels. There were significant differences between the

values obtained. The study by Sun and Mishima [16] also gives different versions of correlations, while there is no clear indication of a correlation being particularly recommended for R134a and all the more for other new refrigerants. For this reason, the authors conducted their own experimental tests in this area.

### 3 Testing facility

The tests were conducted on the experimental set-up whose schematic diagram is presented in Fig. 2. Two refrigerating installations need to be distinguished in the schematic diagram of the testing facility, which work in parallel, i.e.: an installation of a single-stage refrigeration system which is fed from the compressor condensing unit, and a refrigeration installation which feeds the measuring section of the pipe minichannel [2,4].

#### 3.1 Installation of a single-stage compressor refrigeration system

The superheated vapor of the refrigerant which is obtained after compression in the piston compressor 3 of the unit manufactured by *Danfoss* was fed to the lamella condenser 4 that was chilled with air, and then to the container 5 of liquid. From the container 5 the liquid flew through the filter-dryer unit 6 and the electromagnetic valve 7, and reached the lamella air cooler 8 that was thermostatically fed with the aid of the expansion valve 9. The vapor of the refrigerant, which was partly superheated in the flow through the block of the pipe coil of the cooler 8 and on the suction part of the installation was sucked in by the piston compressor 3, and the working cycle of the system was repeated.

#### 3.2 Refrigeration system that operates the measuring section of the minichannel

The condensation process of the refrigerant occurred in a flow inside the pipe minichannel 1 (Figs. 2 and 3). The superheated vapor of the refrigerant after compression in the piston compressor 3 was directed with the aid of the flow regulating valve to the system that feeds the measuring section 1, after the flow through the filter F. Before the inflow of the refrigerant to the inlet cross-section of the measuring section, a heat exchanger 10 chilled with water was installed. Its purpose was to remove the superheat of the

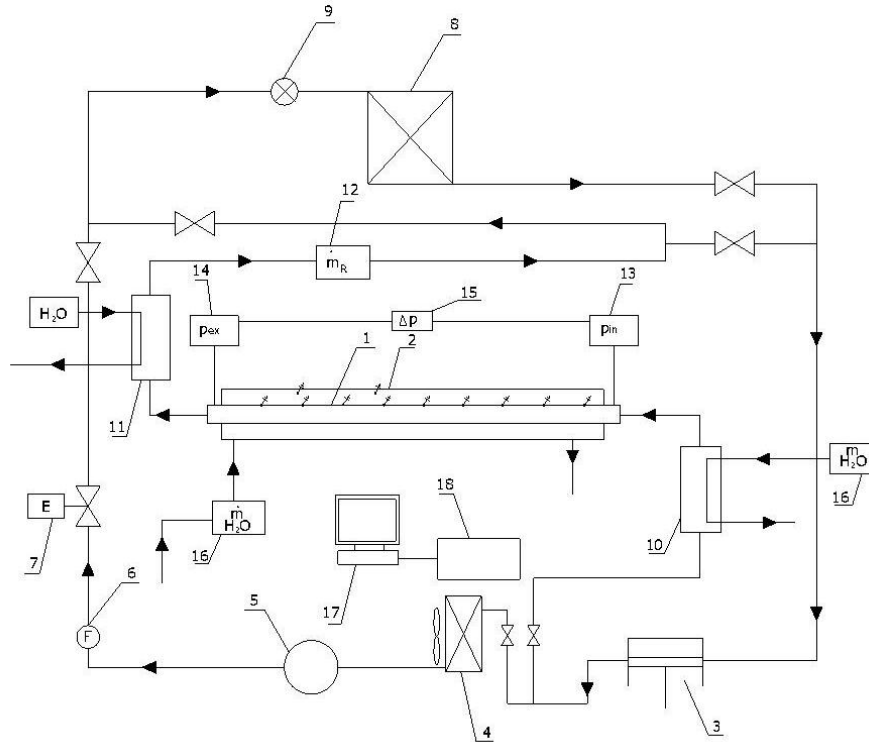

Figure 2. Schematic diagram of the experimental facility: 1 – measuring section of the pipe minichannel, 2 – water channel, 3 – refrigeration compressor installation, 4 – condenser chilled with air, 5 – container of refrigerant liquid, 6 – filter-dryer of refrigerant, 7 – electromagnetic valve, 8 – lamelled air cooler, 9 – expansion valve that feeds the cooler, 10 – heat exchanger to collect refrigerant's superheat, 11 – subcooler of refrigerant's liquid, 12 – electronic flowmeter of refrigerant, 13 – refrigerant's pressure pickup on the inlet to the measuring section, 14 – refrigerant's pressure pickup on the outlet to the measuring section, 15 – refrigerant's differential pressure transducer, 16 – water electronic flowmeter, 17 – computer, 18 – data processing system, F – filter.

refrigerant. The intensity of collection of the superheat was regulated with a change of the flow rate (16) of the water that chilled the exchanger 10. In this manner, the setting was obtained of the required parameters of the state of the vapor of the refrigerant that was supplied to the measuring section. The pressure of the refrigerant on the inflow to the measuring section was measured by means of a piezoresistant sensor 13 with a production converter manufactured by *Endress+Hauser*; the measuring range of the sensor was 0–2.5 MPa (the voltage signal of the pressure was obtained on the output

from the converter that was supplied to the data processing system). A pressure sensor 14 of the same type was installed on the outflow from the measuring section. A drop of pressure of refrigerant along the length of the pipe minichannel was measured by means of a differential pressure sensor 15 with a transducer. The liquid refrigerant that was leaving the measuring section was subcooled in the heat exchanger 11. The flow rate of the refrigerant's liquid was measured by means of the flowmeter 12. The liquid of the refrigerant, once it left the measuring section, was supplied to the installation that fed the cooler 8 (Fig. 2). Any additional cut-off valves that occurred in the refrigeration system served the purpose of an adjustment of the refrigerant's parameters in both refrigeration systems that worked in parallel.

### 3.3 Measuring section

Figure 3 presents a schematic diagram of a pipe minichannel section including control and measuring instrumentation. The pipe minichannel section with internal diameter  $d$  and a total length of 1.000 mm constituted the basic element of the measuring system. The pipe minichannel section was placed in a water channel 21. A water channel was used from an aluminum section with a rectangular cross-section (dimensions: 28×24 mm) and an internal length of 950 mm (this was an active length of the measuring section). The method of how the pipe minichannel was placed in water channel 21 is presented in sectional view  $A-A$  in Fig. 3. In nine cross-sections along the active length of the minichannel, the temperature was measured of its external surface by means of thermocouples of  $K$  that were placed at a distance of 100 mm from each other. In the same cross-sections, thermocouples were installed to measure the chilling water temperature that flew through the water channel. The junctions of these thermocouples were placed at a distance of 19 mm from the bottom of the water channel on its vertical axis.

Figures 2 and 3 present an overall view of the testing facility and the measuring section.

The heat and flow investigations were carried out for R134a, R404A and R407C environmentally friendly refrigerants in relation to the following parameters:

- pipe minichannel internal diameter:  $d = 0.31\text{--}3.3$  mm,
- mass flux density:  $G = 0\text{--}1300$  kg/(m<sup>2</sup>s),



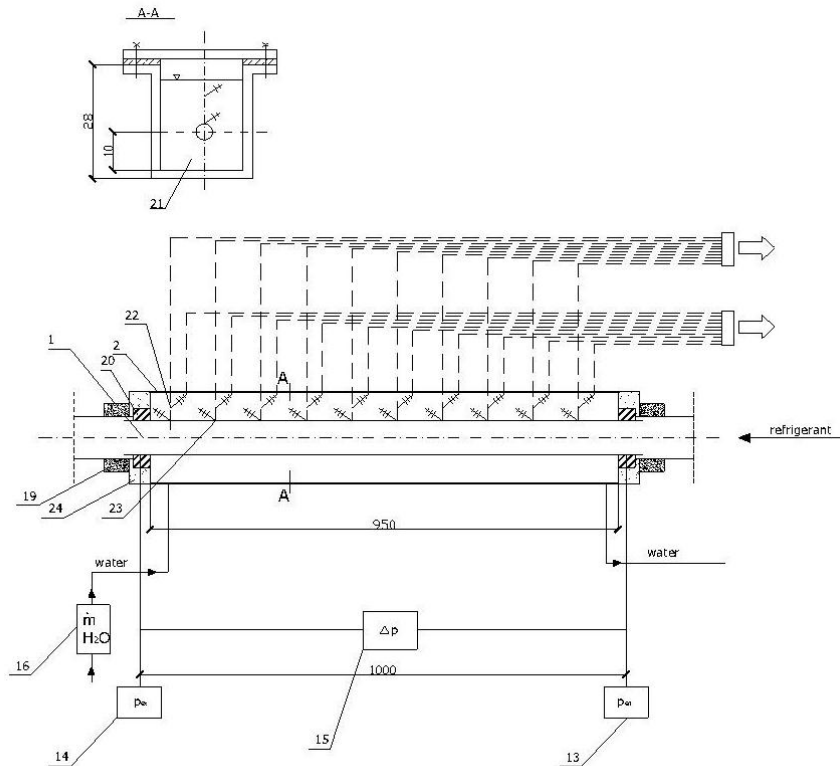

Figure 3. Schematic diagram (sectional view) of the measuring section of the pipe minichannel; 19c copper pipe 8/ 10 mm, 20 – pipe connector, 21 – pipe minichannel refrigeration system, 22 – connector of thermocouple wires of water temperature thermocouples, 23 – connector of thermocouple wires of minichannel surface thermocouples, 24 – isolation, K – thermocouples (the remaining denotations as in Fig. 2).

- heat flux density:  $q = 0\text{--}100 \text{ kW/m}^2$ ,
- condensation temperature:  $T_s = 20\text{--}50 \text{ }^\circ\text{C}$ ,
- quality level:  $x = 0\text{--}1$ .

## 4 Results of experimental investigations

Experimental investigations of condensation of a refrigerant in pipe minichannels were carried out in two ranges, i.e. in the range of an average and local pressure drop. The average values were determined for the whole proper

condensation area (in the range  $x = 0-1$ ). The local pressure drop values were measured in nine cross-sections that were distant from one another by 100 mm on the minichannel length. In accordance with the accepted methodology of experimental investigations, the parameters that were directly measured and the quantities that are identified by means of indirect (computational) methods were identified. The experimental investigations were carried out with the use of pipe minichannels with internal diameter  $d = 0.31, 0.45, 0.64, 0.98, 1.40, 1.60, 1.94, 2.30$  and  $3.30$  mm.

#### 4.1 Results of investigations of flow resistances in averaging conditions

The results of experimental investigations of the dependence of average flow resistance  $(\Delta p/L)_A$  from the mass flux density,  $G$ , of refrigerants R134a, R404A and R407C were graphically interpreted in the system of  $(\Delta p/L)_A$  versus  $G$  for  $d = const$ . Figure 4 presents the experimental characteristics that were obtained as an example for minichannels with internal diameters 2.30 and 3.30 mm. A graphical setting up of the results of experimental investigations of an average flow resistance during the condensation of R404A refrigerant in pipe minichannels is included in Fig. 5.

Figures 6 and 7 present a comparative setting-up of the results of experimental investigations of an average flow resistance in relation to mass flux density during condensation of refrigerant R134a in pipe minichannels with internal diameter 0.98–30 mm. It is clearly evident from presented diagrams that the increase of density of the mass flux of refrigerant flow results in increase of the flow resistance. The nature of the diagram of dependence  $(\Delta p/L)_a$  as a function of  $G$  is close to a parabolic curve, which is in compliance with the laws of hydrodynamics. With a change of the mass flux density in the range  $G = 200-1000$  kg/(m<sup>2</sup>s), there occurred an increase of the flow resistance:

- for  $d = 3.30$  mm,  $(\Delta p/L)_a = 10-70$  kPa/m;
- for  $d = 0.98$  mm,  $(\Delta p/L)_a = 20-350$  kPa/m.

Figure 8 includes a comparative setting-up of the results of the average flow resistance of the refrigerant in relation to its mass flux density for minichannels with diameters  $d = 0.31, 0.45$  and  $0.64$  mm. It is evident from the analysis of the diagrams that with a change of mass flux density of R134a from  $G = 600$  kg/(m<sup>2</sup>s) to  $G = 1000$  kg/(m<sup>2</sup>s), there occurs an increase of flow resistance in minichannels  $d = 0.31-0.64$  mm:

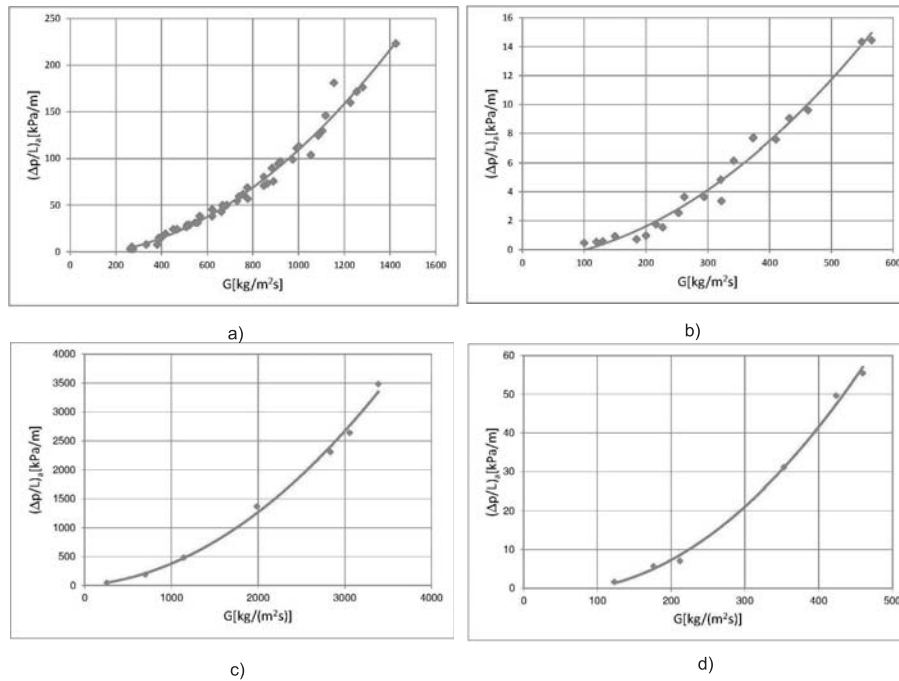

Figure 4. Graphical interpretation of an experimental dependence of flow resistance,  $(\Delta p/L)_a$ , from the mass flux density,  $G$ , during condensation in a pipe minichannel: a) R134a,  $d = 1.40$  mm, b) R134a,  $d = 3.30$  mm, c) R407C,  $d = 0.31$  mm; d) R407C,  $d = 0.98$  mm.

- for  $d = 0.64$  mm: an increase by 204%,
- for  $d = 0.45$  mm: an increase by 161%,
- for  $d = 0.31$  mm: an increase by 112%.

## 4.2 Results of investigations of flow resistances in local conditions

The knowledge of the distribution of the values of local resistances on the path  $L$  of the flow of the refrigerant is significant from the perspective of an analysis of the condensation process in a pipe minichannel. Figure 9 presents as an example the results of experimental investigations of the dependence of the local pressure drop  $(\Delta p/L)_x$  from the quality,  $x$ , during condensation of refrigerants R134a and R404A for the constant values of mass flux density  $G = const$  in range  $G = 234\text{--}866$  kg/(m<sup>2</sup>s) in a pipe minichannel with

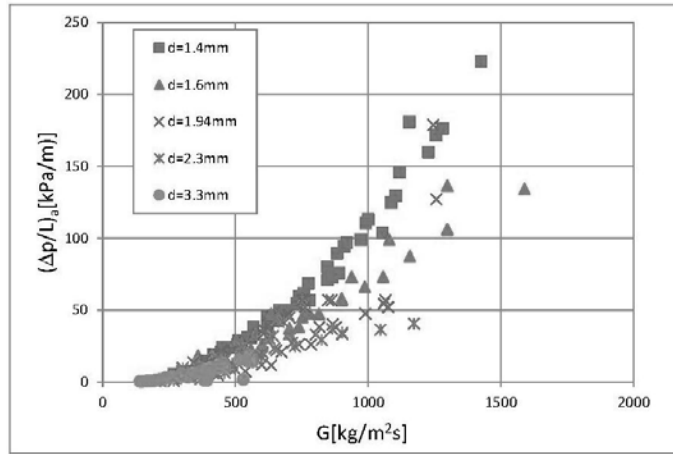

Figure 5. Setting-up of the experimental results of the condensation of R404A refrigerant in pipe minichannels with internal diameters  $d = 1.4\text{--}3.3$  mm.

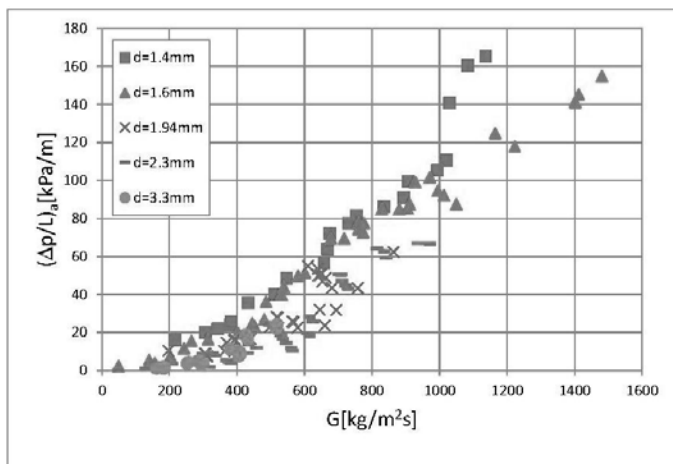

Figure 6. Comparative setting-up of the results of experimental investigations of the condensation of R134a refrigerant in pipe minichannels with internal diameters  $d = 1.4\text{--}3.3$  mm.

internal diameter  $d = 0.98\text{--}3.30$  mm in range  $G = 64\text{--}162$  kg/(m<sup>2</sup>s). Similar dependencies were obtained for other external diameters of minichannels. It is evident from the investigations that were conducted that the diagram of dependence  $(\Delta p/L)_x$  as a function of the quality level,  $x$ , for  $G = \text{const}$  possesses a characteristic course concerning the change of quality level  $x = 1\text{--}0$ .

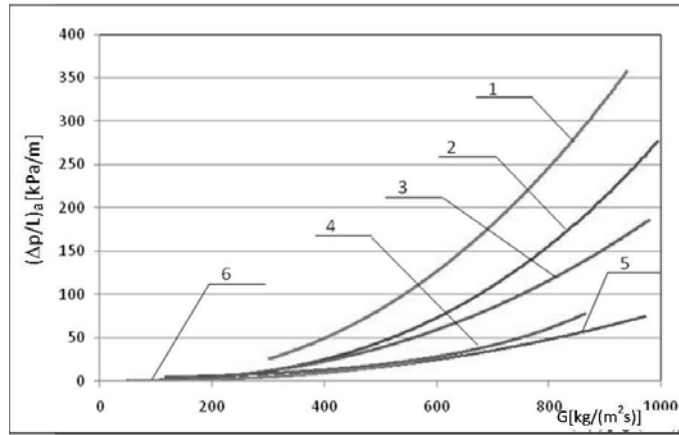

Figure 7. Cumulative setting-up of experimental dependence  $(\Delta p/L)_a$  upon the mass flux density,  $G$ , for refrigerant R134a during its condensation in pipe minichannels with internal diameters  $d = 0.98$ – $3.30$  mm: 1 –  $d = 0.98$  mm, 2 –  $d = 1.40$  mm, 3 –  $d = 1.60$  mm, 4 –  $d = 1.94$  mm, 5 –  $d = 2.30$  mm, 6 –  $d = 3.30$  mm.

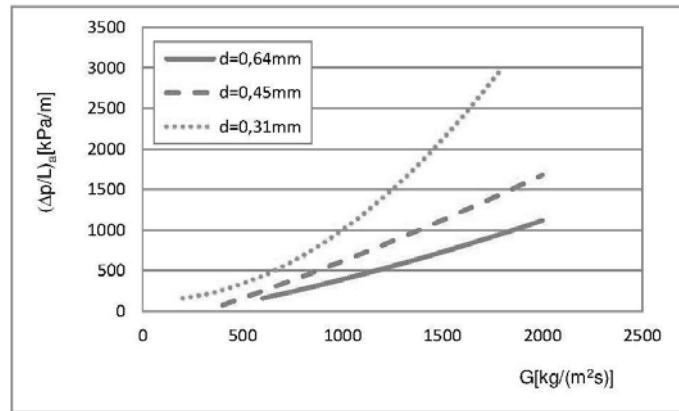

Figure 8. Comparative setting-up of the results of experimental investigations of dependence  $(\Delta p/L)_a$  upon the mass flux density,  $G$ , during the condensation of refrigerant R134a in pipe minichannels with diameters  $d = 0.31$ – $0.64$  mm.

Together with a drop of  $x$  value, there occurs initially a small increase of the local value of the resistance, and then it drops. An increase of mass flux density  $G$  results in a growth of the local flow resistance of the condensing refrigerants.

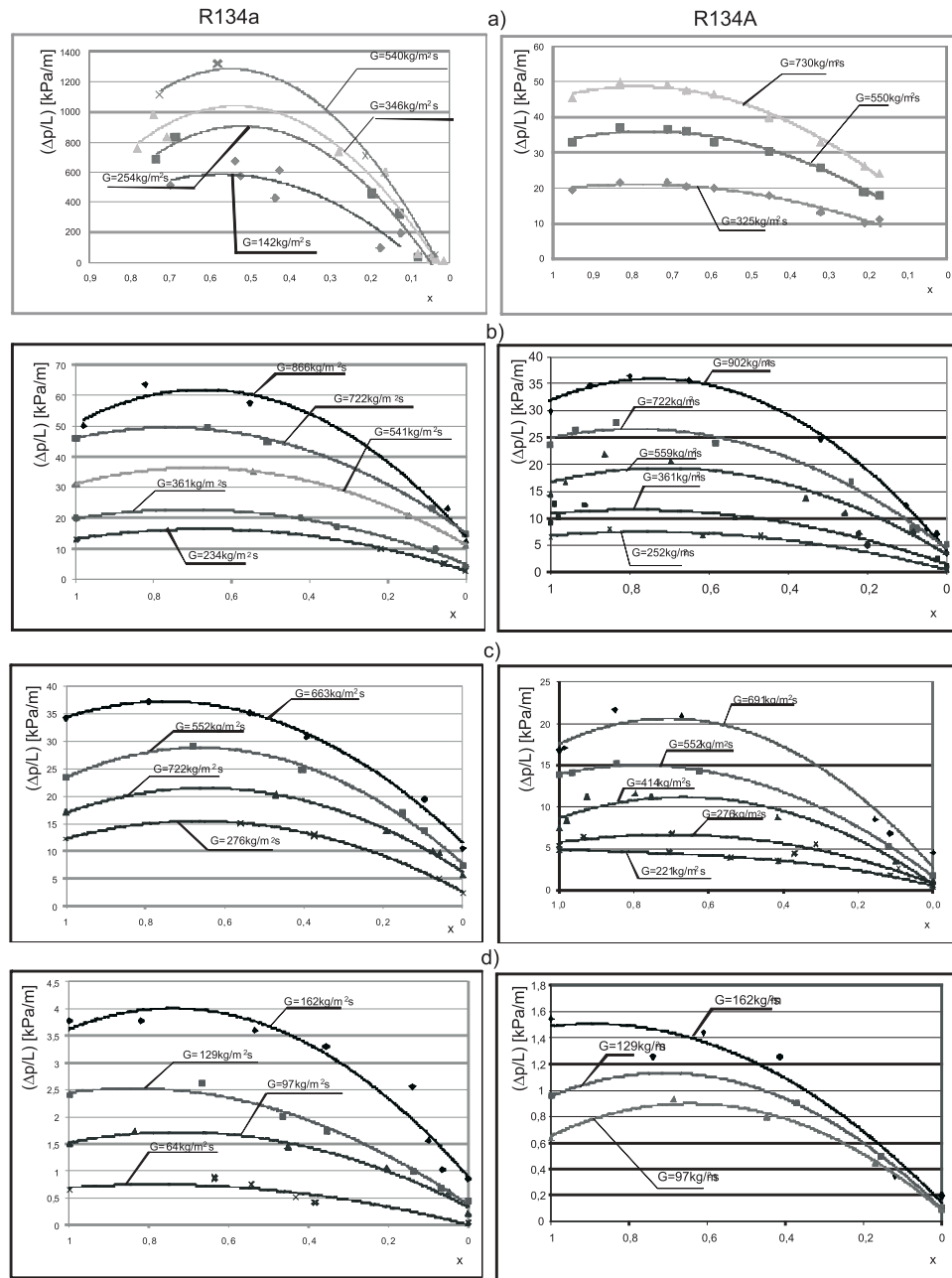

Figure 9. Results of experimental investigations concerning dependence  $(\Delta p/L)_x$  upon the quality level during the condensation of R134a and R404A in pipe minichannels with the following example internal diameters: a)  $d = 0.98$  mm, b)  $d = 1.40$  mm, c)  $d = 1.60$  mm, and d)  $d = 3.30$  mm.

## 5 Comparative analysis concerning flow resistance during condensation in minichannels

The results of experimental investigations concerning the flow resistance of refrigerants during its condensation in pipe minichannels are presented in the form of a dependence of average or local flow resistance from mass flux density and quality level. In both versions, the experimental results were compared with the results according to the following correlations formula: Friedel [9], Chen *et al.* [7], Cavallini *et al.* [9], Garimella [10]. Figure 10 presents the results of this comparison. It follows from this that the results of experimental investigations are the closest to the results of calculations (for the same flow parameters) to the calculations according to the correlations of Friedel [9] and Garimella [10]. The results of the experimental investigations of dependence  $(\Delta p/L)$  as a function of  $G$  for  $x_a = const$  are located the closest to the diagram of this dependence:

- for  $d \leq 1.6$  mm: carried out according to Friedel's correlation [9],
- for  $d > 1.6$  mm: according to Garimella's correlation [10].

Figure 11 includes a comparative analysis of the results of experimental investigations of flow resistance  $(\Delta p/L)_x$  versus quality level,  $x$ , for  $G = const$  and  $d = const$  of R134a refrigerant in minichannels and calculations in accordance with correlations proposed by other authors.

The authors developed their own experimental correlation to describe the local frictional pressure drop for R134a refrigerant during their condensation in a flow in minichannels with internal diameter  $d = 0.31\text{--}3.3$  mm:

$$\left(\frac{\Delta p}{L}\right)_{TPF} = \left(\frac{\Delta p}{L}\right)_{lo} \left[ 0.003p_r^{-4.722} E^{-0.992} + 143.74 \left( \frac{F^{0.671} H^{-0.019}}{We^{0.308}} \right) \right], \quad (8)$$

where:

$$E = (1-x)^2 + x^2 \left( \frac{\rho_l}{\rho_g} \right) \left( \frac{f_{go}}{f_{lo}} \right), \quad (9)$$

$$F = x^{0.98} (1-x)^{0.24}, \quad (10)$$

$$H = \left( \frac{\rho_l}{\rho_g} \right)^{0.91} \left( \frac{\mu_g}{\mu_l} \right)^{0.19} \left( 1 - \frac{\mu_g}{\mu_l} \right)^{0.7}, \quad (11)$$

$$We = \frac{G^2 d}{\sigma \rho_g}. \quad (12)$$

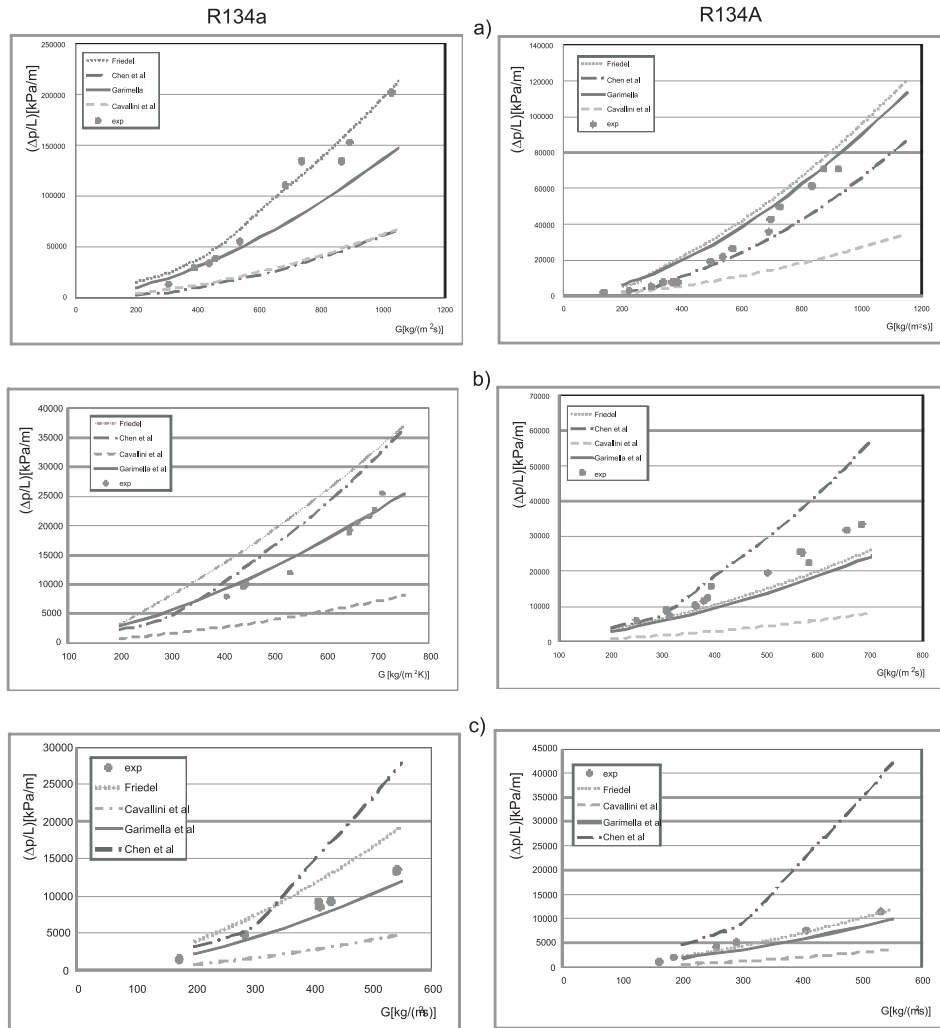

Figure 10. Comparison the results of experimental investigations concerning dependence  $(\Delta p/L)_x$  upon the mass flux density,  $G$  with the results of calculations according to the following correlations: Friedel [9], Chen *et al.* [7], Cavallini *et al.* [6], and Garimella *et al.* [10] for condensation of R134a and R404A in pipe minichannels with the following example internal diameters: a)  $d = 0.98$  mm,  $x = 0.45$ , b)  $d = 1.94$  mm,  $x = 0.55$ , c)  $d = 3.30$  mm,  $x = 0.55$ .



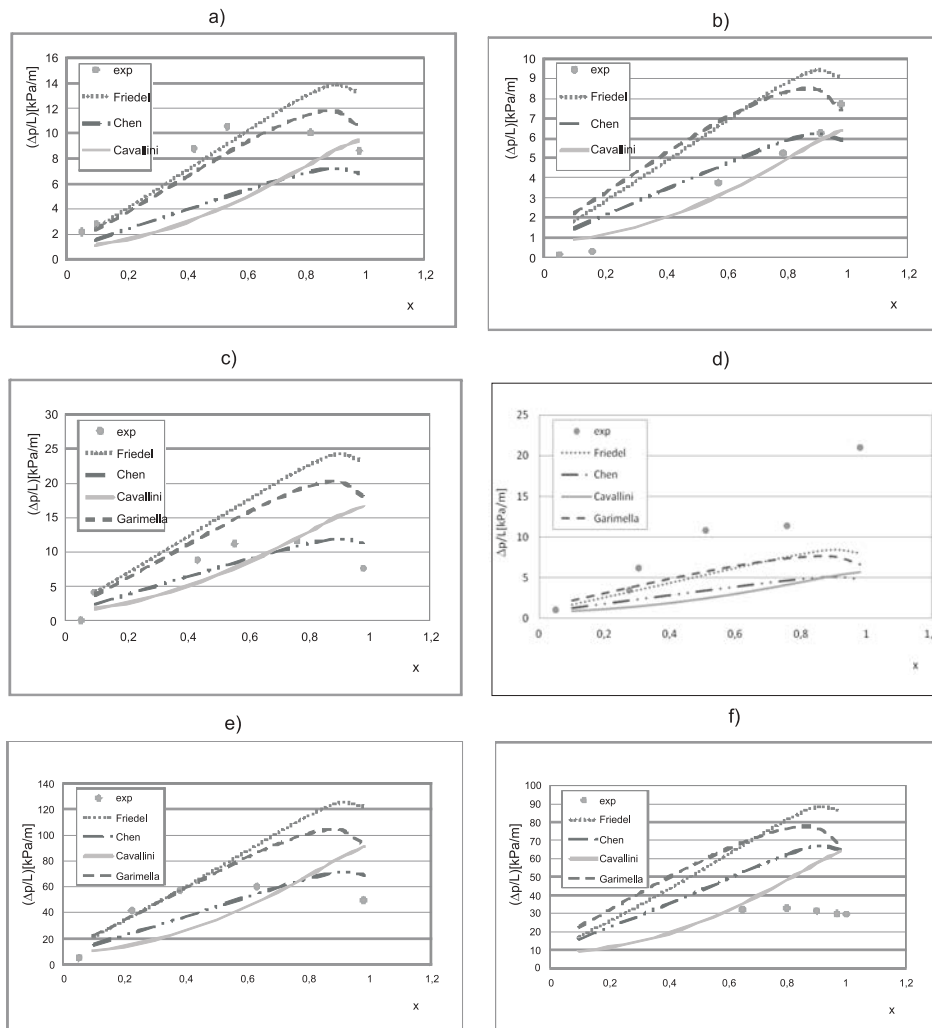

Figure 11. Comparison of experimental investigations of dependence  $(\Delta p/L)_x$  upon the quality,  $x$ , with the results of calculations according to correlations proposed by other authors during condensation of R134a and R404A refrigerant in minichannels with the following diameters: a) R134a,  $d = 2.3$  mm,  $G = 321$  kg/m<sup>2</sup>s,  $T_s = 30$  °C; b) R404A,  $d = 2.3$  mm,  $G = 321$  kg/m<sup>2</sup>s,  $T_s = 43$  °C; c) R134a,  $d = 1.94$  mm,  $G = 376$  kg/m<sup>2</sup>s,  $T_s = 40$  °C; d) R404A,  $d = 1.94$  mm,  $G = 376$  kg/m<sup>2</sup>s,  $T_s = 33$  °C; e) R134a,  $d = 1.4$  mm,  $G = 541$  kg/m<sup>2</sup>s,  $T_s = 45$  °C; f) R404A,  $d = 1.4$  mm,  $G = 866$  kg/m<sup>2</sup>s,  $T_s = 40$  °C.

The friction coefficients  $f_{lo}$  and  $f_{go}$  for Eq. (9) are determined for a single-phase flow for the liquid and gaseous phases respectively, from the Baroczy dependence [1] of the following form:

$$f_x = 8 \left[ \left( \frac{8}{Re_x} \right)^{12} + \left\{ \left[ 2.457 \ln \left( \frac{Re_x}{7} \right)^{0.9} \right]^{16} + \left( \frac{37530}{Re_x} \right)^{16} \right\}^{-1.5} \right]^{1/12}, \quad (13)$$

where the lower index  $x=go$  is applied in the case of the calculation of  $f_{go}$  and  $x = lo$  for  $f_{lo}$ . The same denotations apply to Reynolds' numbers:  $Re_{lo}$  and  $Re_{go}$ .

The verifying calculations of the results of experimental investigations demonstrated that in the range covered by an analysis of correlation (8) there occurred the following two-phase flow structures for both refrigerants: annular and annular-stratified structures. It was found that the results of the experimental tests and calculations from Eq. (8) fall within the compatibility range of  $\pm 25\%$ , which is illustrated in Fig. 12.

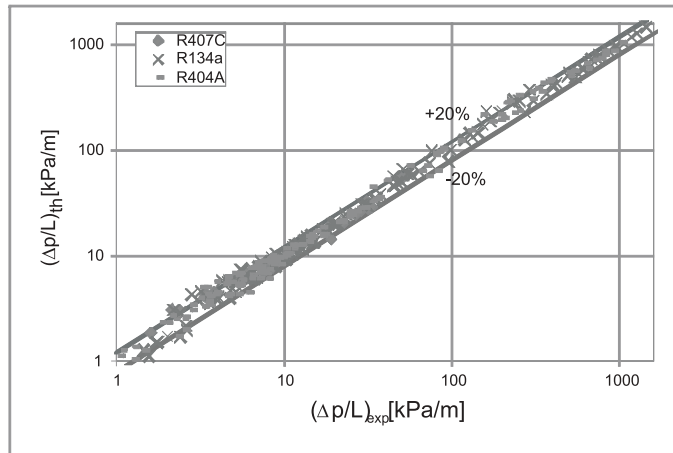

Figure 12. Comparison of the results of experimental investigations and the results of calculations from the correlation (1) concerning the local pressure drop in the flow of R134a, R404A and R407C refrigerants during condensation in pipe minichannels with internal diameters  $d = 0.31\text{--}3.3$  mm.

## 6 Conclusions

1. The pressure drop in a two-phase flow during condensation of refrigerants R134a, R404A and R407C depends of the refrigerant type, the process parameters and the structure of two-phase flow. In the literature, there are no generalised maps of two-phase flow structures for these refrigerant, which makes it very difficult to select an adequate correlation when designing compact condensers.
2. A comparative setting-up of the results of the experimental investigations and calculations from correlations proposed by many authors did not allow for a selection of the most useful correlation.
3. On the basis of the experimental results into the condensation of refrigerants R134a, R404A and R407C in smooth pipe minichannels (made from stainless steel) with internal diameters  $d = 0.31\text{--}3.3$  mm, a new correlation, Eq. (8) was developed for the calculation of the local value of the frictional pressure drop in the range of two-phase flow structures: annular and annular-stratified for the following parameters:  $T_s = 20\text{--}50$  °C,  $x = 0\text{--}1$ ,  $G = 0\text{--}1300$  kg/(m<sup>2</sup>s).

**Acknowledgement** This study was conducted under Research Project No. N N512 456740.

*Received 16 January 2012*

## References

- [1] BAROCZY C.J.: *Correlation of liquid fraction in two-phase flow with application to liquid metals*. Chemical Engineering Progress Symposium **61**(1965), 57, 179–191.
- [2] BOHDAL T., CHARUN H., KUCZYŃSKI W., SIKORA M.: *Investigation of heat exchange and flow resistances during condensation of refrigeration media in minichannels*. In: Proc. XIX International Symposium, Research-Education-Technology, Bremen 2009, 118–121.
- [3] BOHDAL T., CHARUN H., SIKORA M.: *Comparative investigations of the condensation of R134a and R404A refrigerants in pipe minichannels*. Int. J. Heat and Mass Transfer **54**(2011), 1963–1974.
- [4] BOHDAL T., CHARUN H., SIKORA M.: *Pressure drop during the condensation of R134a refrigerant in pipe minichannels*. In: Proc. 6th International Conference on Transport Phenomena in Multiphase Systems, Ryn, Poland, June 28–July 02, 2011, (M.E. Poniewski, S. Alabrudziński S. (Eds.), 2011, 233–240.

- 
- [5] CAVALLINI A., CENSI G., DEL COL D., DORETTI L., LONGO G.A., ROSSETTO L.: *Condensation of halogenated refrigerants inside smooth tubes*. HVAC and Research **8**(2002), 4, 429–451.
- [6] CAVALLINI A., DORETTI L., MATKOVIC M., ROSSETTO L.: *Update on condensation heat transfer and pressure drop inside minichannels*. In: Proc. ICMM2005, 3rd Int. Conf. on Microchannels and Minichannels, Toronto 2005.
- [7] CHEN J.Y., YANG K.S., CHANG Y.J., WANG C.C.: *Two-phase pressure drop of air-water and R410A in small horizontal tubes*. Int. J. Multiphase Flow **27**(2001), 7, 1293–1299.
- [8] COLEMAN J.W., GARIMELLA S.: *Two-phase flow regimes in round, square and rectangular tubes during condensation of refrigerant R134a*. Int. J. Refrigeration **26**(2003), 1, 117–128.
- [9] FRIEDEL L.: *Improved friction pressure drop correlation for horizontal and vertical two-phase pipe flow*. In Proc. European Two-Phase Flow Group Meeting, Paper No. 2, Ispra 1987, Italy.
- [10] GARIMELLA S.: *Condensation flow mechanisms in microchannels: basis for pressure drop and heat transfer models*. Heat Trans. Eng. **25**(2004), 3, 104–116.
- [11] GHIAASIAAN S.M.: *Two-Phase Flow. Boiling and Condensation in Conventional and Miniature Systems*. Cambridge University Press, 2008.
- [12] KANDLIKAR S.G.: *Microchannels and minichannels — history, terminology, classification and current research needs*. In: Proc. First International Conference on Microchannels and Minichannels, New York 2003.
- [13] KANDLIKAR S.G., GARIMELLA S., LI D., COLIN S., KING M.R.: *Heat Transfer and Fluid Flow in Minichannels and Microchannels*. Elsevier 2006.
- [14] LOCKHART R.W. MARTINELLI R.C.: *Proposed correlation of data for isothermal two-phase, two-component flow in pipes*. Chem. Eng. Prog. **45**(1949), 1, 39–45.
- [15] MEHENDALE S.S., JACOBI A.M., SHAH R.K.: *Fluid flow and heat transfer at micro- and meso-scales with application to heat exchanger design*. Applied Mechanics Reviews **53**(2000), 7, 175–193.
- [16] SUN L., MISHIMA K.: *Evaluation analysis of prediction methods for two-phase flow pressure drop in minichannels*. Int. J. Multiphase Flow **35**(2009), 47–54.
- [17] ZHANG M., WEBB R.L.: *Correlation of two-phase friction for refrigerants in small-diameter tubes*. Exp. Thermal and Fluid Science **25**(2001), 131–139.