

Optimal coefficient of the share of cogeneration in the district heating system cooperating with thermal storage

ANDRZEJ ZIĘBIK*
PAWEŁ GŁADYSZ

Silesian University of Technology, Institute of Thermal Technology,
Konarskiego 22, 44-100 Gliwice, Poland

Abstract The paper presents the results of optimizing the coefficient of the share of cogeneration expressed by an empirical formula dedicated to designers, which will allow to determine the optimal value of the share of cogeneration in contemporary cogeneration systems with the thermal storages feeding the district heating systems. This formula bases on the algorithm of the choice of the optimal coefficient of the share of cogeneration in district heating systems with the thermal storage, taking into account additional benefits concerning the promotion of high-efficiency cogeneration and the decrease of the cost of CO₂ emission thanks to cogeneration. The approach presented in this paper may be applicable both in combined heat and power (CHP) plants with back-pressure turbines and extraction-condensing turbines.

Keywords: Coefficient of the share of cogeneration; Cogeneration, Combined heat and power plant; District heating system; Thermal storage

Nomenclature

\dot{G} – mass flux of substance
 I – capital cost
 k – unit cost
 N – power

*Corresponding author. E-mail address: andrzej.ziebiak@polsl.pl

- T – temperature
- \dot{Q} – rate of heat

Greek symbols

- α – share of cogeneration
- η – efficiency
- σ – index of cogeneration
- τ – time

Subscripts

- el – electrical
- h – heating and ventilation
- htw – hot tap water
- me – electromechanical
- o – heating season
- op – off-peak time
- p – peak time
- pr – power rating
- T – turbine

Abbreviations

- CHP – combined heat and power
- DH – district heating
- EES – engineering equation solver
- PES – primary energy saving
- RC – red certificate

1 Introduction

The coefficient of the share of cogeneration, defined as a ratio of the maximum rate of heat transmitted by the cogeneration unit (back-pressure turbine or extraction-condensing turbine) to the maximum rate of heat from the CHP plant depends on the duration curve of the demand for heat. In district heating systems the demand for heat is in the heating season expressed by the duration curve of ambient temperature and the demand for hot tap water. The ratio of the heat demand required for the preparation of hot tap water to the maximum flux of heat for heating purposes has been decreasing in the last two decades, due first of all, to the improvement of buildings insulation thanks to thermomodernization. The growing share of hot tap water in the maximum demand for heat is accompanied by increasing value of the coefficient of the share of cogeneration. The application of thermal storage permitting to increase the peak production of electricity also effects its improvement.

Up to now the coefficient of the share of cogeneration in district heating systems cooperating with CHP plants, but without thermal storage, has been assumed on the level 0.45 [1]. This result has been achieved using the objective function based on the mean annual profit resulting from the difference between the running costs of the separate production of heat and electricity and the cost of CHP operation without taking into consideration additional benefits concerning the promotion of high-efficiency cogeneration and the decrease of the cost of CO₂ emission thanks to cogeneration. The value 0.45 mentioned above concerns also those cases when the ratio of heat demand for preparing hot tap water to the maximum heat flux in district heating does not exceed 10%. In contemporary district heating systems the share of the heat demand for the production of hot tap water increases, whereas the share of the heat consumption for heating purposes decreases [8]. This may lead to considerable changes in the share of cogeneration in district heating systems, particularly in the case when thermal storage is additionally installed.

2 District heating systems with CHP plants (CHP-DH Systems)

The demand of thermal energy for heating, ventilation and air conditioning depends on the ambient temperature presented in the form of duration curves set up for the respective climatic zones of the country. This rate of heat is calculated from the equation:

$$\dot{Q}_h = \dot{Q}_{h \max} \frac{t_{in} - t_a}{t_{in} - t_{a \min}}, \quad (1)$$

where:

- \dot{Q}_h – current value of the rate of heat,
- $\dot{Q}_{h \max}$ – maximum demand for heat ($t_a = t_{a \min}$),
- t_{in} – internal temperature,
- t_a – current ambient temperature,
- $t_{a \min}$ – lowest calculated ambient temperature characteristic for any given climatic zone.

The average rate of heat required to preheat tap water is calculated by means of the relation:

$$\dot{Q}_{htw} = \dot{G}_{htw} c_w (t_{htw} - t_{tw}), \quad (2)$$

where:

- \dot{Q}_{htw} – rate of heat required to preheat tap water,
- \dot{G}_{htw} – mass flux of hot tap water,
- t_{htw} – temperature of hot tap water,
- t_{tw} – temperature of tap water.

Applying the Raiss equation [6] describing the universal duration curve of ambient temperature, we may write:

$$\dot{Q}_h = \dot{Q}_{h \max} \frac{t_{in} - t_{as} + (t_{as} - t_{a \min}) \left[1 - \sqrt[3]{\frac{\tau}{\tau_o}} + \left(\frac{\tau}{\tau_o} \right)^2 \left(1 - \frac{\tau}{\tau_o} \right) \right]}{t_{in} - t_{a \min}}, \quad (3)$$

where:

- t_{as} – ambient temperature at which the heating season starts,
- τ_o – duration of the heating season,
- τ – time.

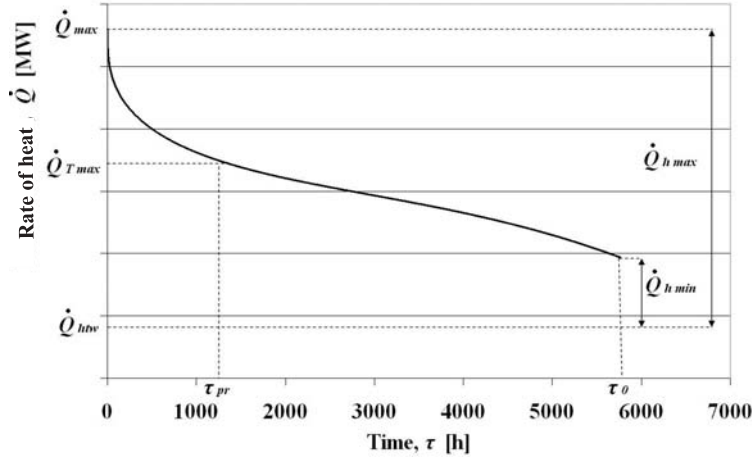

Figure 1. Duration curve of the demand for heat in district heating system.

Figure 1 presents the duration curve of the demand for heat needed for heating, ventilation and production of hot tap water. This duration curve is characterized by the following indices:

- the ratio of the rate of heat for the production of hot tap water in the heating season to the maximum rate of heat for heating and ventilation purposes:

$$m = \frac{\dot{Q}_{htw}}{\dot{Q}_{h \max}}, \quad (4)$$

where \dot{Q}_{htw} denotes the rate of heat required for the production of hot tap water,

- degree of fluctuations in the heat demand for heating and ventilation:

$$m_o = \frac{\dot{Q}_{h \min}}{\dot{Q}_{h \max}}. \quad (5)$$

The ratio m will be a parameter in further considerations. In the case of district heating the degree of fluctuations in the heat demand may be assumed to be constant.

3 The application of thermal storage for the purpose of increasing the peak production of electricity in CHP plants

The economical effectiveness of heat and electricity cogeneration in CHP plants supplying district heating systems can be increased by applying storage tanks of hot network water. An adequate control of the heating load of the turbines permits to increase the production of electricity during its peak demand and to decrease it during the remaining part of the day. The simple diagram concerning a CHP plant with a back-pressure turbine and connected thermal storage has been presented in Fig. 2 [11].

The installation of thermal storage permits to increase the power output of the turbogenerator during the peak load by $\Delta N_{el p}$ and to decrease the load of the turbogenerator by $-\Delta N_{el op}$ in the off-peak time, keeping the production of electricity on a constant level throughout the day thanks to the constant production of heat, basing on the mass flux of back-pressure steam. The constant production of heat bases on the assumption that the ambient temperature during the day remains on a constant mean level. Assuming that the power output of a turbine without thermal storage remains on the average level resulting from the average demand for heat during the day, we get the following relation:

$$(\bar{N}_{el} + \Delta N_{el p}) \tau_p + (\bar{N}_{el} - |\Delta N_{el op}|) \tau_{op} = E_{el D}, \quad (6)$$

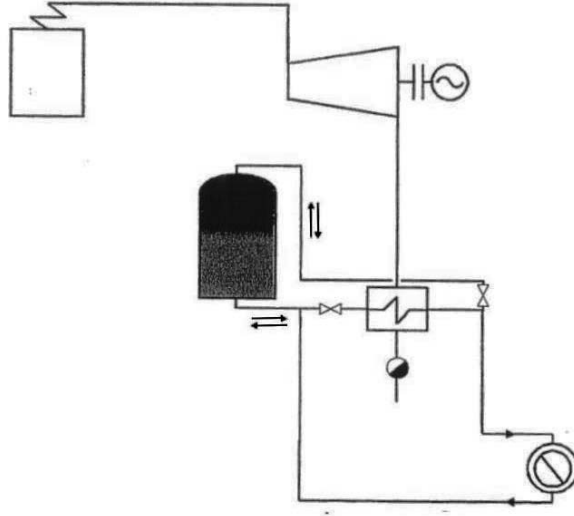

Figure 2. Thermal storage in a CHP plant with a back-pressure turbine.

where:

- \bar{N}_{el} – mean value of the power output during the full day,
- $\Delta N_{el p}$ – increased load of the turbogenerator during the peak in the electroenergy system (loading the thermal storage),
- $-\Delta N_{el op}$ – decreased load of the turbogenerator during the off-peak time in the electroenergy system (unloading the thermal storage),
- τ_p, τ_{op} – duration of the peak load and the time off-peak load,
- $E_{el D}$ – electricity production during the whole day (24 hours).

From Eq. (6) results the relation between the increase of the peak power output and the decrease of the power output in the off-peak time:

$$\frac{\Delta N_{el p}}{|\Delta N_{el op}|} = \frac{\tau_{op}}{\tau_p}. \quad (7)$$

The increase of the peak power output and the decrease of the power output in the off-peak time are accompanied, respectively, by the increase and decrease of the back-pressure steam, the relation between them being analogous to Eq. (7):

$$\left| -\Delta \dot{G}_{bp op} \right| = \Delta \dot{G}_{bp p} \frac{\tau_p}{\tau_{op}}, \quad (8)$$

where:

- $\Delta\dot{G}_{bpp}$ – increase of the flux of back-pressure steam in the peak load in the electric power system,
- $-\Delta\dot{G}_{bpop}$ – decrease of the flux of back-pressure steam in the off-peak time.

At an increased mass flux of back-pressure steam the maximum capacity of the turbine is, of course, limited. The fluxes $\Delta\dot{G}_{bpp}$ and $-\Delta\dot{G}_{bpop}$ have their counterparts in the form of the fluxes $\Delta\dot{G}_{nwp}$ and $-\Delta\dot{G}_{nwop}$, respectively, denoting the increase of the flux of network water flowing through the heat exchanger during the peak time and accumulated in the thermal storage, and the decrease of the flux of network water flowing through the heat exchanger during the off-peak time and supplied from the thermal storage to the district heating network:

$$\Delta\dot{G}_{nwp} = \frac{\Delta\dot{G}_{bpp}(h_{bp} - h_c)}{c_w(t_h - t_r)}, \quad (9)$$

$$-\Delta\dot{G}_{nwop} = \frac{\Delta\dot{G}_{bpp} \frac{\tau_p}{\tau_{op}} (h_{bp} - h_c)}{c_w(t_h - t_r)}, \quad (10)$$

where:

- $\Delta\dot{G}_{nwp}$ – increased mass flux of network water flowing through heat exchanger in the peak time,
- $-\Delta\dot{G}_{nwop}$ – decreased mass flux of the network water flowing through the heat exchanger during the off-peak time,
- t_h, t_r – temperature of hot and return network water,
- h_{bp}, h_c – specific enthalpy of back-pressure steam and the condensate leaving the heat exchanger.

The relation between the fluxes $\Delta\dot{G}_{nwp}$ and $-\Delta\dot{G}_{nwop}$ is analogical to Eq. (7):

$$\left| -\Delta\dot{G}_{nwop} \right| = \Delta\dot{G}_{nwp} \frac{\tau_p}{\tau_{op}}. \quad (11)$$

The thermal storage installed in a CHP plant with a back-pressure turbine is loaded during the peak time of the electric power system and unloaded in the off-peak time. The peak time has been assumed to last for eleven hours (from 7 a.m. to 1 p.m. and from 4 p.m. to 9 p.m.).

Determination of the volume of thermal storage is based on the diagram presenting the increase and decrease of network water of the inevitable surplus of network water which is to be accumulated. This surplus is the

difference between the extreme values of the network water in the thermal storage:

$$S = G_{nw \max} - G_{nw \min} , \quad (12)$$

where:

- S – inevitable surplus of accumulated hot water,
- $G_{nw \max}$ – maximum network water in the thermal storage,
- $G_{nw \min}$ – minimum network water in the thermal storage.

Basing on the diagram concerning the increase and decrease of the flux of network water (Fig. 5), the diagram of the increase of accumulated network water is plotted in compliance with the formula:

$$G_{nw} = \int_0^{\tau} \dot{G}_{nw} d\tau , \quad (13)$$

where:

- G_{nw} – amount of water in the thermal storage,
- \dot{G}_{nw} – mass flux of loading or unloading.

The volume of the thermal storage V_{ts} results from the relation:

$$V_{ts} = \frac{S}{g_{ts}} , \quad (14)$$

in which g_{ts} denotes the unit capacity of accumulation of the thermal storage; in the case of storing of network water, the unit capacity of accumulation is equal to the density of water at the mean temperature in the thermal storage.

Figure 5 presents the exemplary diagram of loading and unloading fluxes of the thermal storage and the diagram of the inevitable surplus of accumulated network water.

4 Algorithm of the choice of the optimal share of cogeneration in district heating systems supplied with heat from a CHP plant with thermal storage

Generally, the algorithm is based on the method of choosing the power rating concerning a CHP plant with a back-pressure turbine [6], supplemented by the procedure of calculating the volume of thermal storage and

additional components concerning the benefits resulting from high-efficiency cogeneration, the decrease of CO₂ emissions and additional production of peak electricity.

The objective function is the mean annual profit resulting from the difference between the costs of the supply of heat and electricity from installations of separate production (heating plant and system power station) and the costs of supplying the municipal consumers with heat and electricity by a CHP plant. The optimal choice of the power rating of the turbine is based on the duration curve of the heat demand (Fig. 1). The decision variable is the coefficient of the share of cogeneration in district heating systems [7]:

$$\alpha_{CHP} = \frac{\dot{Q}_{T\max}}{\dot{Q}_{\max}}, \quad (15)$$

where:

- $\dot{Q}_{T\max}$ – maximum rate of heat provided by the CHP,
- \dot{Q}_{\max} – maximum rate of heat which is the sum of the maximum rate of heat for heating and ventilation and the rate of heat for the preparation of hot tap water.

Each value of the coefficient of the share of cogeneration is reflected in the time τ_{pr} of operation of the CHP at the power rating. The objective function in the optimization supplemented by additional components concerning thermal storage takes, in comparison with [13], the following form:

$$\begin{aligned} \phi = & (N_{elpr}\tau_{pr} + \int_{\tau_{pr}}^{\tau_o} N_{el}d\tau)(k_{elr} + RC) + (-\Delta E_{chPF}e_{CO_2})k_{CO_2} + C_p - C_{op} - \\ & - I_T(\rho_T + \beta_T) - I_{ts}\rho_{ts} - \frac{1+\delta_b}{\eta_{Eb}} \left(\frac{N_{elpr}\tau_{pr}}{\eta_{mepr}} + \int_{\tau_{pr}}^{\tau_o} \frac{N_{el}}{\eta_{me}} d\tau \right) k_{chf}, \end{aligned} \quad (16)$$

where:

- N_{elpr} – power rating of the turbogenerator,
- τ_{pr} – time of the CHP operation at power rating,
- N_{el} – actual load of the turbogenerator,
- k_{elT} – unit cost of electricity from the system power stations,
- RC – red certificates (guarantees of origin of the electricity from high-efficiency cogeneration),
- ΔE_{chPF} – savings of the chemical energy of primary fuels thanks to cogeneration,
- k_{CO_2} – carbon price,

- e_{CO_2} – emission of CO₂ per unit of the chemical energy of fuel,
 C_p – receipts due to additional production of peak electricity,
 C_{op} – decrease of receipts concerning off-peak electricity production,
 I_T – capital cost of the turbogenerator,
 I_{ts} – capital cost of thermal storage ,
 ρ_T, ρ_{ts} – annual rate of fixed costs of the turbogenerator and thermal storage, respectively,
 β_T – annual rate of repairs and maintenance costs,
 δ_b – share of the cost of auxiliary materials concerning the boiler,
 η_{Eb} – energy efficiency of the boiler,
 η_{mepr} – electromechanical efficiency of the turbogenerator at power rating,
 η_{me} – actual electromechanical efficiency,
 $k_{ch,f}$ – unit cost of the chemical energy of fuel.

Red certificates are assigned when electricity is produced in the high-efficiency cogeneration. The criterion of the qualification of high-efficiency cogeneration depends on the value of the *PES* (primary energy savings) index [2,7,10]:

$$PES = 1 - \frac{1}{\frac{\eta_h}{\eta_{ref\ hp}} + \frac{\eta_{el}}{\eta_{ref\ ps}}}, \quad (17)$$

where:

- $\eta_{ref\ hp}$ – reference value of the energy efficiency in separate production of heat (heating plant),
 $\eta_{ref\ ps}$ – reference value of the energy efficiency in separate production of electricity,
 η_h, η_{el} – partial arithmetical efficiency of heat and electricity production in a CHP plant.

If $PES \geq 10\%$ the cogeneration unit is considered to be a high-efficiency CHP plant.

Energy savings of chemical energy of the input fuel is calculated as follows:

$$-\Delta E_{chPF} = PES \left(\frac{1}{\eta_{ref\ hp}} + \frac{\sigma}{\eta_{ref\ ps}} \right) Q_{CHP}, \quad (18)$$

where:

- Q_{CHP} – denotes the annual production of heat in cogeneration,
 σ – index of cogeneration (ratio of the production of electricity in cogeneration to the production of heat in cogeneration).

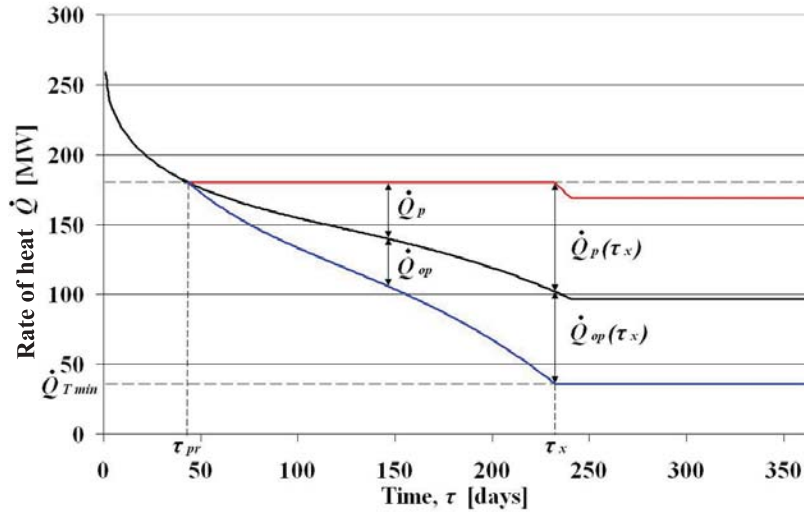

Figure 3. Auxiliary diagram concerning the algorithm of calculating the thermal storage.

The choice of the volume of thermal storage is based on the duration curve of heat demand and on the accepted quantity $\dot{Q}_{T \max}$ determining the maximum rate of heat achieved in the heat exchanger from the mass flux of back-pressure steam at the nominal load of the turbine (Fig. 3). In the period of time $(0, \tau_{pr})$ heat cannot be accumulated, because the turbine is assumed to operate without any overload. Thus, the power rating of the turbogenerator is at the same time the maximum power output of the turbogenerator. In the remaining interval of time accumulation is however possible within the limits imposed by restrictions. Therefore, practically the period of accumulation may be considered to be $\tau_{ac} > \tau_{pr}$ due to the admissible minimum values of the fluxes of loading and unloading. There are also two restrictions with respect to the operation of the turbine:

- a) restrictions imposed by the power rating of the turbine, i.e. the maximum rate of heat $\dot{Q}_{T \max}$,
- b) restriction resulting from the maximum value of the power output; according to [12] it has been assumed that $N_{el \min} = 0.2N_{el n}$.

The ambient temperature t_{ax} and also the time τ_x on the duration curve of heat demand (depending strictly on the ambient temperature) mark the point at which the restriction: a) becomes inactive and the restriction,

b) starts to be active. This point is calculated by means of the equations:

$$\dot{Q}_p(\tau_x) = \frac{\tau_{op}}{\tau_p} \dot{Q}_{op}(\tau_x) , \quad (19)$$

$$\dot{Q}_p(\tau_x) = \dot{Q}_{T \max} - \dot{Q}(\tau_x) , \quad (20)$$

$$\dot{Q}_{op}(\tau_x) = \dot{Q}(\tau_x) - \dot{Q}_{T \min} , \quad (21)$$

$$\dot{Q}(\tau_x) = \frac{\dot{Q}_{T \max} + \dot{Q}_{T \min} \frac{\tau_{op}}{\tau_p}}{1 + \frac{\tau_{op}}{\tau_p}} , \quad (22)$$

where:

- $\dot{Q}_p(\tau_x)$ – rate of heat loading the thermal storage,
- $\dot{Q}_{op}(\tau_x)$ – rate of heat unloading the thermal storage,
- $\dot{Q}_{T \min}$ – minimum rate of heat obtained from the back-pressure steam.

According to the restriction b) it may be approximately well assumed, that:

$$\dot{Q}_{T \min} = 0.2 \dot{Q}_{T \max} \quad (23)$$

and thus:

$$\dot{Q}_T(\tau_x) = \dot{Q}_{T \max} \frac{1 + 0.2 \frac{\tau_{op}}{\tau_p}}{1 + \frac{\tau_{op}}{\tau_p}} . \quad (24)$$

Figure 3 illustrates the way of choosing the volume of thermal storage in compliance with the duration curve of heat demand, taking into account the restrictions mentioned above. The procedure of calculating the volume of thermal storage has been dealt with in Section 3. In the presented paper the volume of the thermal storage was chosen in the point τ_x .

The objective function (16), together with the auxiliary Eqs. (17), (18) and (24) and the set of balance equations constituting a simulating mathematical method of the CHP plant is an optimizing mathematical model of choosing the optimal power rating of the cogeneration system which has been used to elaborate a computer code by means of EES (Engineering Equation Solver).

5 Description of the computer code and the results of calculations

The computer code is based on implemented equations describing the individual elements of the system by mass and energy balances. For a proper

operation of the program it is necessary to determine the parameters at the characteristic points of the simplified model of a CHP plant (Fig. 4), including steam pressure in the turbine bleeders, temperature limitations in the heat exchangers, nominal efficiencies etc. The regeneration system consists of three regenerative heat exchangers (RH1, RH2 and RH3) in order to preheat the condensate prior to feeding it into the boiler (B). Two heat exchangers (HEA and HEB) cover the basic heat demand resulting from the characteristics of the district heating network. The peak heat demand is covered by the pressure-reducing valve (PRV).

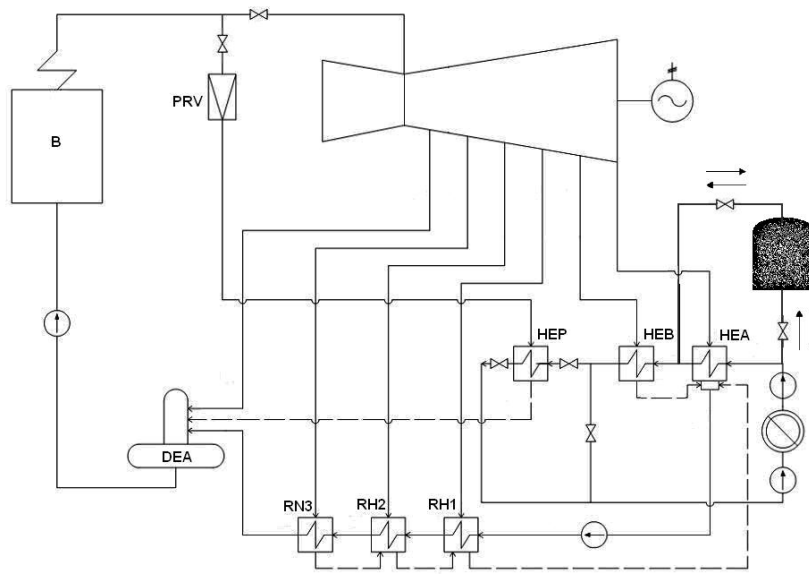

Figure 4. Simplified model of a CHP plant with thermal storage.

The described model of the CHP plant was included into an already existing district heating system, for which the thermal characteristics of the heating network had been preset. The analyzed heating network operates according to the qualitative-quantitative regulation described in [4,5]. As characteristic input data, the parameters \dot{Q}_{\max} , m_o and m have been introduced.

The EES program allows to introduce directly the dependences describing the characteristics of the heating network, which improves the calculation, thus reducing the time required to perform such analysis.

According to the algorithm presented in Section 4 calculations have been carried out concerning the thermal storage. Figure 5 presents exemplary

results of such calculations.

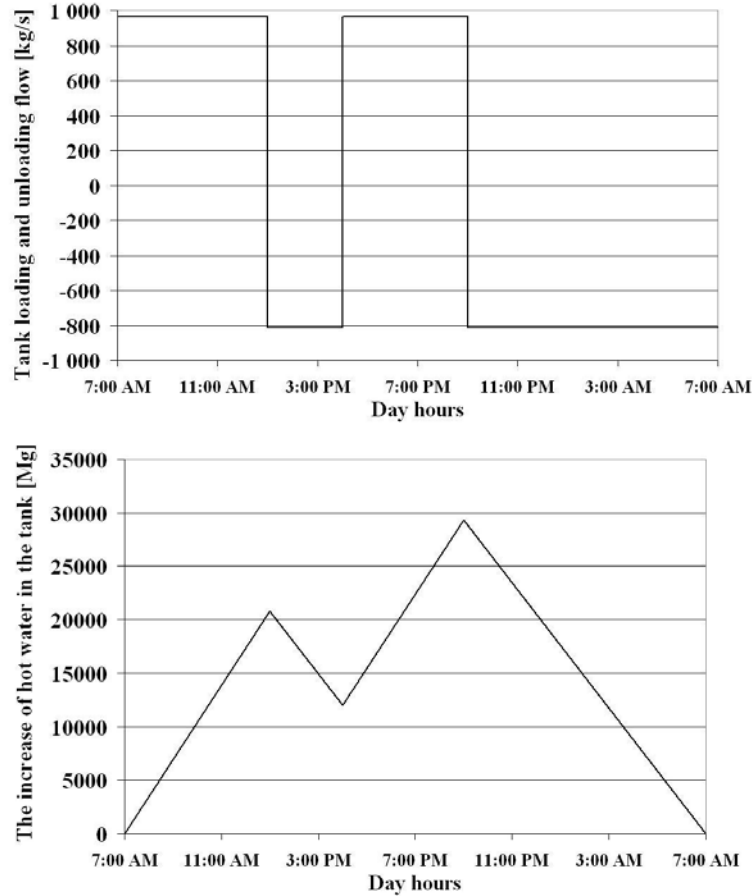

Figure 5. Modes of the thermal storage operation.

Figure 6 provides the objective function in the case of $m_o = 0.15$ and the varying ratio m . A considerable influence of this latter quantity on the optimum value of the share of cogeneration in district heating systems (CHP- DHS) [3] $\alpha_{CHP_{opt}}$ is evident. The maximum of the objective function is shifted towards higher values of the rate of heat from the outlet of the turbine with the increasing parameter m characterizing the share of heat for preparing hot tap water. The dependence of the optimal coefficient of the share of cogeneration in district heating systems on the value m characterizing the share of heat demand for the production of hot tap

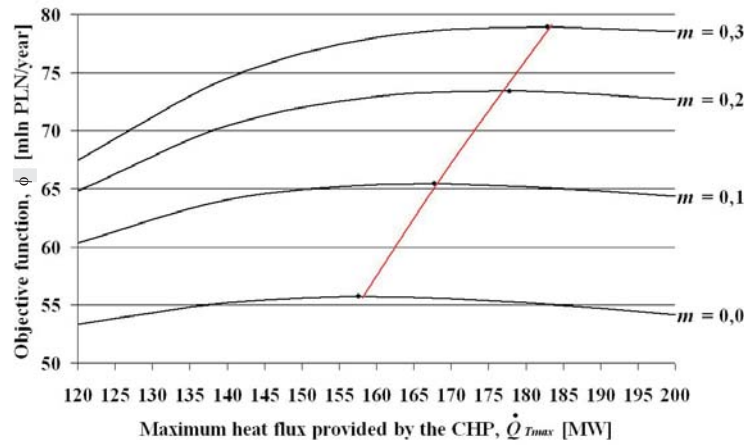

Figure 6. Objective function depending on the value m characterizing the share of heat for the production of hot tap water.

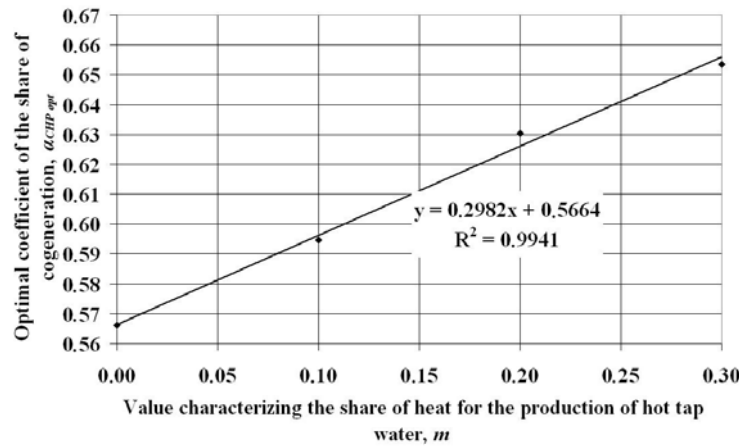

Figure 7. Dependence of $\alpha_{CHP_{opt}}$ on the value m characterizing the share of heat for the production of hot tap water.

water (Fig. 7) is as follows:

$$\alpha_{CHP_{opt}} = 0.2982m + 0.5664. \tag{25}$$

The empirical dependence (25) is obligatory in the range of the value m from 0 to 0.3, in which range the simulation investigations were carried out. It is also the range of the value m practically applied in district heating systems. In comparison with the results presented in [13] the optimum

values of the share of cogeneration increase by about 10%. This results from the application of thermal storage.

The dependence (25) of $\alpha_{CHP_{opt}}$ on the value m characterizing the share of heat for production of hot tap water may be applied in the designing of district heating systems with a cogeneration unit (CHP-DHS). The parameter m is known from the duration curve of heat demand, and next from the dependence (25) the optimal coefficient of the share of cogeneration in the district heating system may be determined and thus the power rating of the turbine can be chosen.

6 Conclusions

The values of the coefficient of the share of cogeneration in covering the demand for heat in district heating systems, applied so far in design, are rather low, due first of all to the increasing share of the demand for heat to prepare hot tap water in comparison with the heat demand for heating purposes. This results from the improvement in the insulation of buildings within the frame of thermomodernization.

High efficiency cogeneration ($PES \geq 10\%$) involves, thanks to “red certificates”, an improvement of the economical effectivity of cogeneration. Also savings of the chemical energy of fossil fuels, and thus also the reduction of CO₂ emissions improve the economical effectivity of cogeneration. These factors influence the increase of the optimal share of cogeneration in district heating systems. As has been assessed, taking into account these factors, they leads to an increase of the optimal value of this share by about 20% [13].

In this paper results of investigations have been presented concerning the influence of the application of thermal storage in order to increase the peak production of electricity. The installation of a tank of network hot water improves the economical effectivity of cogeneration, and thus also to a further increase of the optimal value of the share of cogeneration. The results presented in this paper indicate that the optimal share of cogeneration in district heating systems grows additionally by about 10% in comparison with the results attained by the authors of [13].

The final result of these investigations, similar to those presented in [13], is the empirical formula which may help designers to choose the optimal coefficient of the share of cogeneration in modern district heating systems.

Acknowledgments This paper was elaborated within the frame of the grant No N R 06 0004 06/2009 “CHP STRATEG” supported by the Polish Ministry of Science and High Education and the National Centre for Research and Development.

Received 10 October 2011

References

- [1] ANDRZEJEWSKI S.: *Fundamentals of Designing of Power Plant*. WNT, Warszawa 1974 (in Polish).
- [2] *Directive 2004/8/EC of the European Parliament and of the Council of 11 February 2004 on the promotion of cogeneration based on a useful heat demand in the internal energy market and amending Directive 92/42/EEC*.
- [3] HORLOCK J.H.: *Cogeneration – Combined Heat and Power (CHP). Thermodynamics and Economics*. Krieger Publishing Company, Malabar, Florida 1997.
- [4] MARECKI J.: *Combined Heat and Power*. WNT, Warsaw 1991 (in Polish).
- [5] MUSZER T.: *Thermo-economical analysis of re-powering of heating plant in high-efficiency cogeneration unit on example of Heating Plant Gliwice*. MSc thesis, Silesian University of Technology, Gliwice 2010.
- [6] SZARGUT J., ZIĘBIK A.: *Fundamentals of Thermal Engineering*. PWN, Warszawa 2000 (in Polish).
- [7] SZARGUT J., ZIĘBIK A.: *Combined Heat and Power Plants*. Polish Academy of Sciences, Katowice-Gliwice 2007 (in Polish).
- [8] SZCZECHOWIAK E.: *Specificity of municipal heat market*. In: Proceedings of the Seminar “How to get money on the free energy market”. Centre of Excellence OPTI Energy, Gliwice 2005 (in Polish).
- [9] WOLF M.: *Enzyklopädie der Energiewirtschaft. T.2 Belastungskurven und Dauerlinien in der elektrischen Energiewirtschaft*. Springer-Verlag, Berlin 1959.
- [10] ZIĘBIK A.: *Combined heat and power in Poland according to the EC Directive on promotion of cogeneration*. Archives of Thermodynamics **27**(2006), 4, 3–12.
- [11] ZIĘBIK A., ZUWAŁA J.: *Technical and economical analysis of application of thermal storage in CHP plant with backpressure turbine in order to maximize the peak production of electricity*. Gospodarka Paliwami i Energią **2**(2002), 8–12 (in Polish).
- [12] ZIĘBIK A., ZUWAŁA J.: *Determination of the optimum power rating of a backpressure steam turbine in a cogeneration system with hot water storage tank*. Technical University of Warsaw. Scientific Works. Mechanical Engineering z. **202**, 349–360, Warsaw 2003.
- [13] ZIĘBIK A., GLADYSZ P.: *Optimal coefficient of the share of cogeneration in district heating systems*. In: Proceedings of ECOS 2011, Novi Sad, Serbia, July 2011.