

Analysis of cyclic combustion of the coal-water suspension

AGNIESZKA KIJO-KLECZKOWSKA*

Institute of Thermal Machinery, Czestochowa University of Technology, Armii
Krajowej 21, 42-201 Czestochowa, Poland

Abstract Combustion technology of the coal-water suspension creates a number of new possibilities to organize the combustion process fulfilling contemporary requirements, e.g. in the environment protection. Therefore the in-depth analysis is necessary to examine the technical application of coal as a fuel in the form of suspension. The research undertakes the complex investigations of the continuous coal-water suspension as well as cyclic combustion. The cyclic nature of fuel combustion results from the movement of the loose material in the flow contour of the circulating fluidized bed (CFB): combustion chamber, cyclone and downcomer. The experimental results proved that the cyclic change of oxygen concentration around fuel, led to the vital change of both combustion mechanisms and combustion kinetics. The mathematical model of the process of fuel combustion has been presented. Its original concept is based on the allowance for cyclic changes of concentrations of oxygen around the fuel. It enables the prognosis for change of the surface and the centre temperatures as well as mass loss of the fuel during combustion in air, in the fluidized bed and during the cyclic combustion.

Keywords: Coal-water suspension; Cyclic combustion of suspension; Fluidized Bed; Kinetics of combustion reaction; Mechanism of fuel combustion; Mathematical model of coal-water fuel cyclic combustion

*E-mail address: kijo@kkt.pcz.czyst.pl

Nomenclature

c	–	specific heat capacity, J/kgK
q_V	–	voluminal heat source, W/m ³
r	–	radius, m
S	–	surface area, m ²
T	–	temperature, K
V	–	volume, m ³

Greek symbols

ρ	–	density, kg/m ³
α	–	heat transfer coefficient, W/m ² K
λ	–	thermal conductivity, W/mK

Subscripts

ot	–	ambient of coal-water suspension
------	---	----------------------------------

1 Introduction

The combustion technology in the circulating fluidized bed (CFB) boilers features numerous advantages which include combustion of waste materials and the high combustion efficiency. One of the crucial problems which have not been presented in the literature related to coal-water fuels, and which should be resolved, is the mechanism of combustion in CFB, from the point of view of the cyclic interruption process, and reignition of coal-water suspension. The circulating flux determining the mechanism of combustion also plays essential role in keeping balanced temperature of 850 °C in all zones of combustion chamber, allowing the lowest SO_x and NO_x emissions. The specificity of combustion in CFB forces the mixing of fuel inside the combustion chamber — the internal circulation and the contour circulation occurring in the combustion chamber, the separator and the downcomer (Fig. 1). Thus, the fuel combustion becomes the cyclic process, comprising a repeated heating, ignition, combustion, extinction and cooling. Coal-water suspension is most frequently made of after-flotation slurry with the moisture content of 20–40%, calorific value of 8–10 MJ/kg and the ash content of 20–35% [1]. The necessity to undertake the research related to coal-water suspensions in our country results from the fuel structure of the Polish power industry where 97% of electric energy is produced from coal. Such unfavorable fuel balance causes excessive load for our natural environment which is mainly due to NO_x, SO₂, CO₂ emissions and dust production. It also causes big increase of the area necessary for growing

permanent furnace waste disposal. For this reason our mining industry is forced to supply still better fuel and has to apply more concentrated coal. It causes the constant waste increase in the form of after-flotation slurry. The best utilization method of the slurry is to burn it in the form of coal-water suspension. Improvement of the process required to urgently undertake the research explaining this type of combustion technology. In the specialist literature we can find some texts concerning coal-water suspensions as well as in-depth papers dealing with the combustion processes of various fuels, including fuel wastes [2–11]. The current research is directed into two main problems: 1) to present a study on the combustion technology of low-concentration coal-water suspension which will decrease NO_x emission. The suspensions are made of coal slurries which are formed during the coal cleaning process, 2) combustion of low concentration coal-water suspensions, where good stability is preserved which enables to substitute the petrochemical fuel, this research is mainly carried out in China [12].

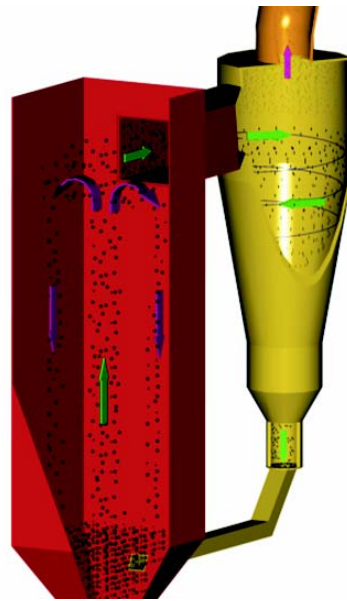

Figure 1. Fuel movement in the boiler with circulating fluidized bed (combustion chamber, cyclone, and downcomer).

2 The research stand and measurements methodology

The research undertakes experiments aiming at explanation of mechanism and combustion kinetics in the conditions of periodic combustion and extinction of coal-water suspension. In order to determine precisely the periodicity impact on the sequence of events in the coal-water suspension combustion, it was necessary to eliminate all complicated aerodynamic conditions of combustion of the fuel. Periodicity of the combustion process was achieved by alternate air and nitrogen flux on the coal-water suspension at the suggested time intervals. Experimental character of the research required the test stands preparation, as well as working out of the measurements methodology. Figure 2 presents the stand design which allowed to

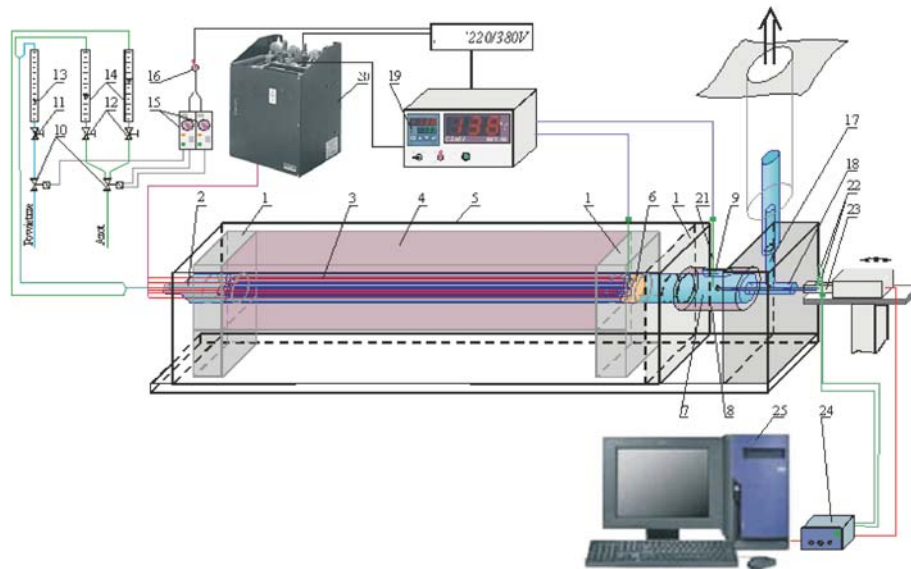

Figure 2. Experimental stand: 1 – blocks of ceramic material, 2 – 67 mm in diameter quartz pipe, 3 – heating elements, 4 – thermal insulation, 5 – steel sheet, 6 – ceramic sieve, 7 – combustion chamber, 8 – thermal insulation of the chamber, 9 – sight-hole for visualization of the process, 10 – electric valves, 11, 12 – control valves, 13, 14 – rotameters, 15 – time transmitters, 16 – relay switch, 17 – furnace gas extractor, 18 – measurement input, 19 – microprocessor thermoregulator, 20 – three-phase power controller, 21 – NiCr-Ni thermocouple, 22 – PtRh10-Pt thermocouple, 23 – extensometer scale, 24 – measurement card, 25 – computer.

investigate the continuous coal particles combustion, and the cyclic combustion in the stream of air. The research stand was made of ceramic blocks (1) in which the quartz pipe was put (2). The heating element of the stand comprised three heating coils of 2.0 kW. Each heating coil (3) was placed in six small quartz tubes. These tubes were built into the quartz tube which was thermally insulated by fiber material Al_2O_3 (4) and which was covered with the steel sheet (5). Behind the heating element, the ceramic sieve (6) was installed in order to stabilize the air and nitrogen flux. Combustion chamber constituted the quartz pipe (7), which was additionally thermally insulated (8), to keep the necessary temperature of the entering gas and to reduce the heat loss. Application of the quartz pipe and the sight-glass in the metal shield (9) allowed to observe directly, to film and to photograph the combustion process of the suspension. The compressed air or the nitrogen was transported to the quartz tube (2) through the electro-valves (10), control valves (11, 12), and rotameters (13, 14). Time transmitters (15) with a switch (16) regulating operation of electrovalves allowed to change automatically the flux time of the gas. In the last ceramic block, there were two holes whose function was to carry out the exhaust fumes (17). The holes also served as the measurement entrance to the combustion chamber (18). To regulate the temperature inside the combustion chamber, the Lumel microprocessor thermoregulator was applied (19). The regulator controlled the work of the tri-phase Lumel power controller (20) supplying the main heating elements (3) (gas heater) allowing to measure the actual temperature with accuracy of measurements to 2 °C. The temperature measurements in the combustion chamber were carried out by means of the thermocouple NiCr-NiAl (21). Figures 3 and 4 present the second stand design. It allowed to investigate the continuous and cyclic combustion of coal-water suspension in air and in the fluidized bed. The research stand (Fig. 3) was made of ceramic blocks (1, 2) in which the quartz pipes were put (3, 7). The heating element of the stand comprised three heating coils of 2.0 kW. Each heating coil (4) was placed in six small quartz tubes (5). These tubes were built into the quartz tube which was thermally insulated by fiber material Al_2O_3 and which was covered with the steel sheet (6). Combustion chamber constituted the quartz pipes (7, 8), which was additionally insulated thermally, to keep the necessary temperature of the entering gas and to reduce the heat loss. Application of the quartz pipe and the sight-glass in the metal shield (14) allowed to observe directly, to film and to photograph the fuel combustion process. Compressed air was transported to the quartz

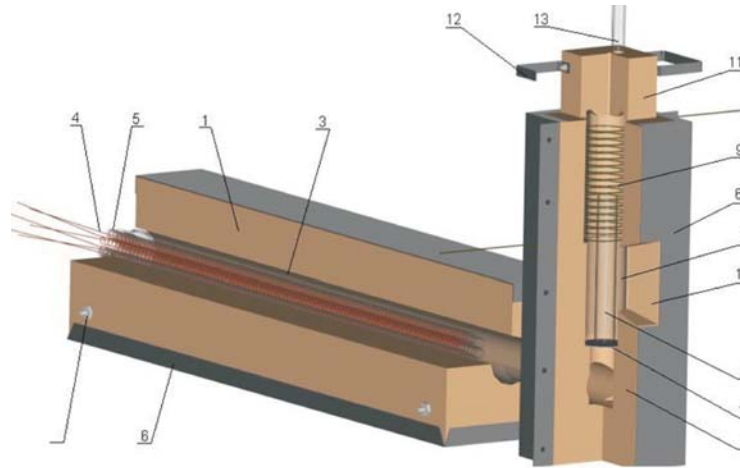

Figure 3. Research stand station: 1,2 – blocks of ceramic material, 3 – quartz pipe, 4 – heating elements, 5 – quartz pipes, 6 – steel sheet, 7,8 – combustion chamber, 9 – warmer, 10 – ceramic sieve, 11 – block of ceramic material, 12 – handles, 13 – furnace gas extractor, 14 – sight-hole for visualization of the process, 15 – screws.

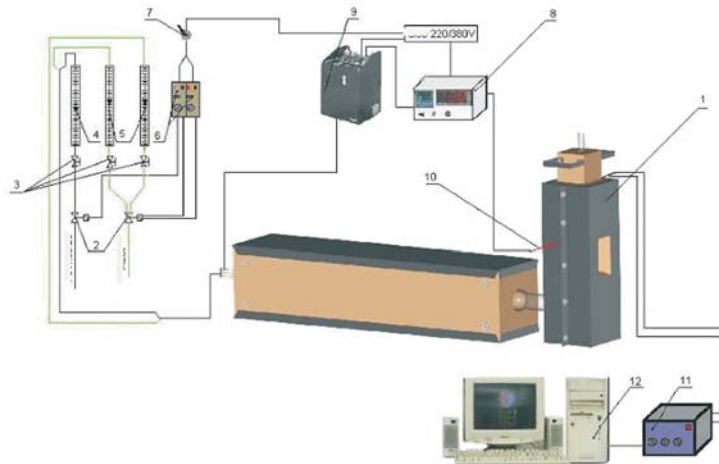

Figure 4. Research stand scheme: 1 – research stand, 2 – electric valves, 3 – control valves, 4,5 – rotameters, 6 – time transmitters, 7 – relay switch, 8 – microprocessor thermoregulator, 9 – three-phase power controller, 10 – NiCr-Ni thermocouple, 11 – measurement card, 12 – computer.

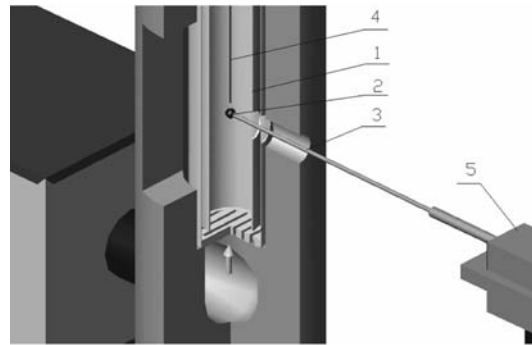

Figure 5. Measurements methodology: 1 – combustion chamber, 2 – coal-water suspension, 3 – PtRh10-Pt thermocouples, 4 – NiCr-NiAl thermocouple, 5 – scales.

tube through the electrovalves, the control valves, and the rotameters. The fumes were removed outside by means of a fan fume cupboard. To regulate the temperature inside the combustion chamber, the Lumel microprocessor thermoregulator was applied (8 – Fig. 4). The temperature measurements in the combustion chamber were carried out by means of the thermocouple NiCr-NiAl (10 – Fig. 4). In order to establish the centre and surface temperature of the coal-water suspension, a special instrument stalk was constructed (Fig. 5).

It had two thermocouples PtRh10-Pt (7) and a built in scale pan of an extensometer scale (8). One of the thermocouples was located inside the fuel, while the other served as a basket which was to support the fuel. It also touched the surface of the coal-water suspension (4). The thermocouples and the extensometer scale were connected to the measurement card and to the computer in order to record the experimental results.

The essential stage of the preliminary work was to make out a suspension fuel drop, which was a mixture of coal dust (with appropriate particles) and water. The coal properties applied in the research are shown in Tab. 1. In order to produce the coal-water suspension it was necessary to prepare coal dust after grinding it and sifting. The particle fractions prepared in this way were weighed on a laboratory scale. To prepare the suspension a laboratory pipette of 1 μl accuracy was used.

Table 1. Analysis of the fuel used in the research (air-dry state).

Fuel	Moisture	Ash	Volatiles	Calorific Value	Total Sulphur	Fixed Carbon
	[%]	[%]	[%]	[kJ/kg]	[%]	[%]
Brown coal	14.5	18.5	42.5	18460	1.1	24.5
Hard coal (mine Sobieski)	12.4	16.7	27.9	21558	1.4	43.0
Slurry of coal (coal mule – mine Sobieski)	4.51	39.43	20.45	15024	0.72	35.3
Hard coal (mine Staszic)	2.7	20.1	28.6	24634	0.9	48.6
Anthracite	1.5	2.5	3	39350	0.2	93.0

3 Experimental research

The research undertakes the complex investigations of the coal-water suspension combustion. Most attention was paid to the experiments analyzing the coal-water suspension combustion in relationship to the conditions of the process. In-depth experiments enabled to define the accurate physical model of the coal-water suspension drop combustion process. It enabled to work out the set of equations taking into consideration all phenomena accompanying combustion. The appropriate initial and limiting conditions were formulated and the mathematical description of the combustion realities was located.

The research included:

- determination of temperature changes of the suspension during combustion in air stream and in the fluidized bed conditions (continuous combustion);
- determination of mechanism and kinetics of cyclic combustion of coal water suspension (by alternate air and nitrogen flux on the coal-water suspension);
- working out of a mathematical model of coal-water suspension continuous and cyclic combustion.

3.1 Continuous and cyclic combustion of coal-water suspension

The combustion analysis of the suspension fuel drop required following of its behavior in the particular process stages. A drop of suspension fuel after introduction to a high temperature medium, changes its size at the initial combustion stages, as a result of evaporation and the volatile release and the solid substance combustion. The degree of initial expanding and then shrinking of a drop, during the process, depends on the type of coal dust and its structure. It was observed that during the intensive volatile combustion occurs a sudden temperature rise of a coal-water suspension drop. After ignition of vaporized suspension an intensive suspension temperature increase to its maximum value was found. It was noticed that combustion time of the suspension with the highest volatiles matter content was the shortest. The increase of moisture content in the suspension leads to the time extension and to the temperature lowering of fuel ignition. After the char ignition, there was the surface temperature increase. When the temperature reached the maximum value, its decrease was observed. It was caused by the shift of the combustion into the internal part of the fuel and the cooling of the fuel surface. The sample was made of the growing ash layer around the char.

It was observed, that the extension of the time of residence of fuel in nitrogen (during the cyclic combustion) leads to noticeable decrease of the mean fuel temperature (Figs. 6–8). The time extension of the fuel combustion during the cyclic processes is related to the reduction of the mass loss.

The basic aim of the research was to identify the impact of moisture in the suspension, temperature in the combustion chamber and gas velocity on the mass rate of continuous and cyclic combustion of the suspension fuel. To carry out the research the rotary and uniform research schedule PS/DS-P $\lambda(\lambda)$ [13] was used which, due to the parallel change of all process parameters, enabled to catch the interactions between the decisive parameters for combustion. The research carried out gives the vast material that included experiment results of the suspension combustion in various conditions, that were anticipated by the research program. To sum up, one should state, that in the first combustion stage of coal-water suspension occurs evaporation of moisture, present in the drop of suspension fuel. After the evaporation stage there is heating and devolatilization of the agglomerate which leads to thermal decomposition. The next stage is the non-homogeneous combustion of the agglomerate that is characterized

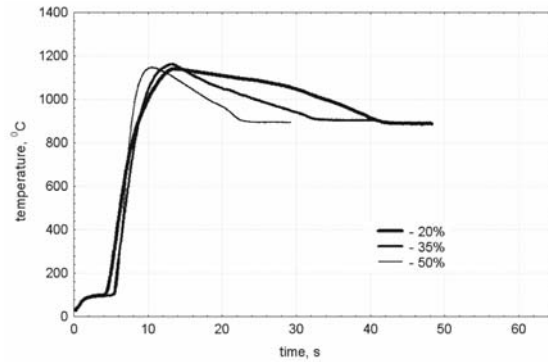

Figure 6. Relation between moisture of suspension (20%, 35%, 50%) and temperature of hard coal-water suspension (mine Sobieski) during continuous combustion.

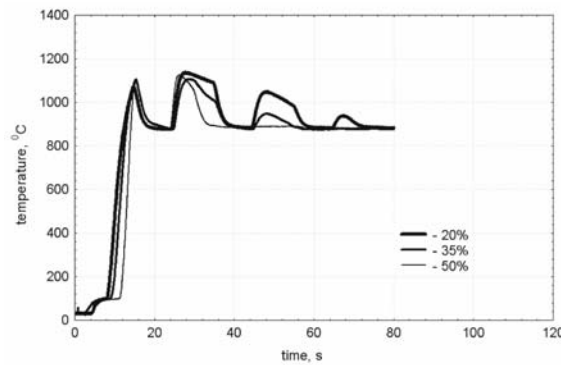

Figure 7. Relation between moisture of suspension (20%, 35%, 50%) and temperature of hard coal-water suspension (mine Sobieski) during cyclic combustion $10s_A/10s_N$ (s_A/s_N – time combustion in air/time residence in nitrogen).

by the absence of flame occurring during volatile combustion. The char-agglomerate combustion period is definitely longer than the ignition time and volatile combustion [14].

The mass rate of suspension combustion was calculated according to the relationship:

$$\dot{m}_c = \frac{m_c - m_a}{\tau_c} \text{ [mg/s] ,} \quad (1)$$

where:

- m_c – coal-water suspension mass (before process of combustion), mg;
- m_a – ash mass (after process of combustion), mg;
- τ_c – combustion time of coal-water suspension, s.

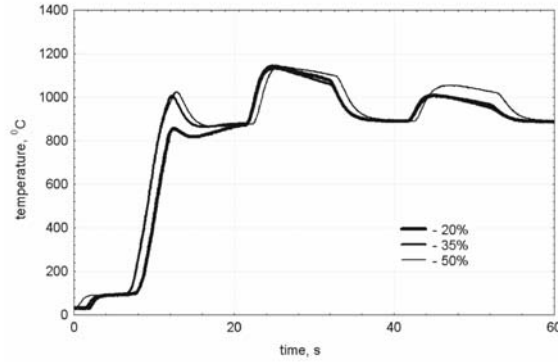

Figure 8. Relation between moisture of suspension (20%, 35%, 50%) and temperature of hard coal-water suspensionl (mine Sobieski) during cyclic combustion $10s_A/30s_N$ (s_A/s_N – time combustion in air/time residence in nitrogen).

After the statistic analysis was carried out, it was found that the most representative function approximating the measurements results was the quadratic multinomial:

$$\begin{aligned} \tilde{z} = & b_{00} + b_{01}\hat{x}_1 + b_{02}\hat{x}_2 + b_{03}\hat{x}_3 + b_{11}\hat{x}_1^2 + b_{22}\hat{x}_2^2 + \\ & + b_{33}\hat{x}_3^2 + b_{12}\hat{x}_1\hat{x}_2 + b_{13}\hat{x}_1\hat{x}_3 + b_{23}\hat{x}_2\hat{x}_3, \end{aligned} \quad (2)$$

where:

- b – regression factors;
- x_k – established decision-making parameters, defined as initial quantities, respectively:
- x_1 – moisture content in coal-water suspension – W , 20–50%;
- x_2 – temperature in coal-water suspension ambient – T_{ot} , 800–900 °C;
- x_3 – velocity of gas – v , 0.4–0.8 m/s.

Regression equation (2) allowed to determine the mass rate of coal-water suspension combustion at various conditions of continuous and cyclic process (Figs. 9 and 10). In order to establish the effect of the process cyclical nature on the fuel combustion rate, it was necessary to investigate the relationships between the oxygen diffusion rate, the char surface and the chemical oxidation kinetics. It is shown in the presented diagrams that the continuous fuel combustion in the stream of air took place in the temporary area with a clear advantage of the diffusion factor. The fuel combustion was determined by all the examined factors [14]. In the case of the diffusion combustion, the rapid chemical reactions led to the oxygen concentration decrease on the fuel surface and, as a result, the oxygen influx from am-

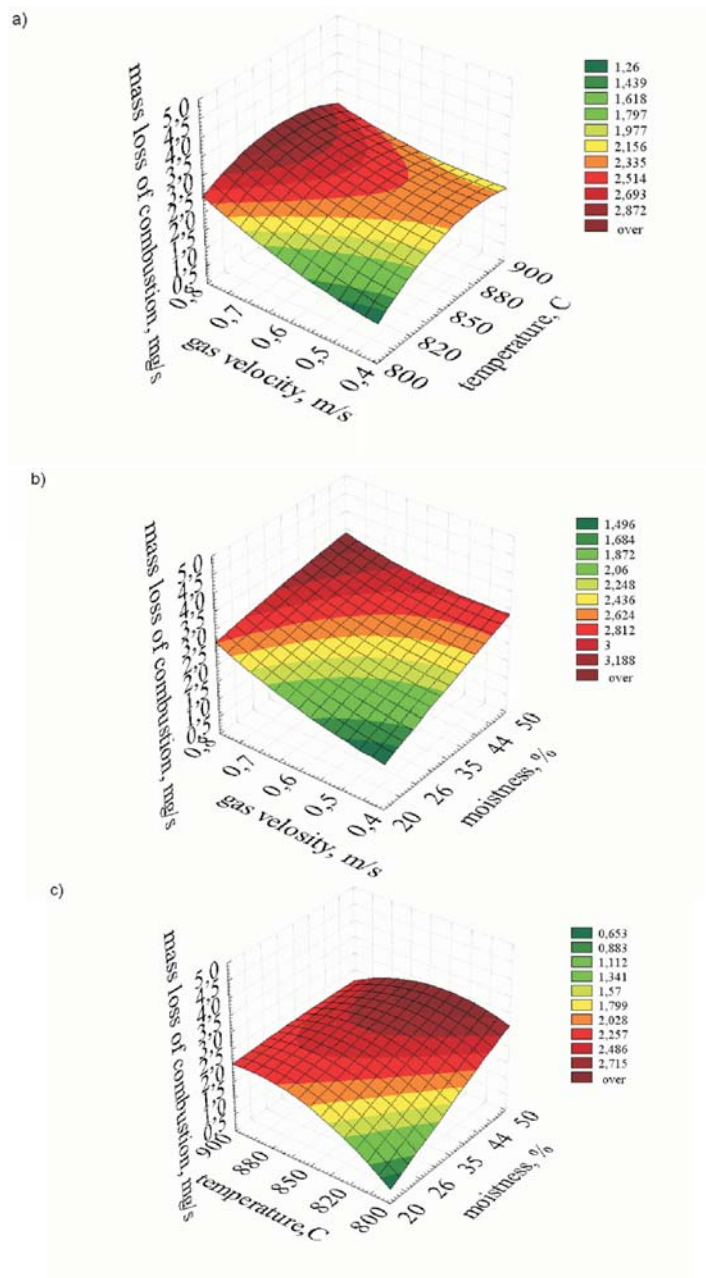

Figure 9. Relation between: a) temperature in the combustion chamber and gas velocity, b) gas velocity and moisture of suspension, c) temperature in the combustion chamber and moisture of suspension and the mass rate of fuel combustion during continuous combustion; hard coal dust (mine Sobieski) : below $250 \mu\text{m}$.

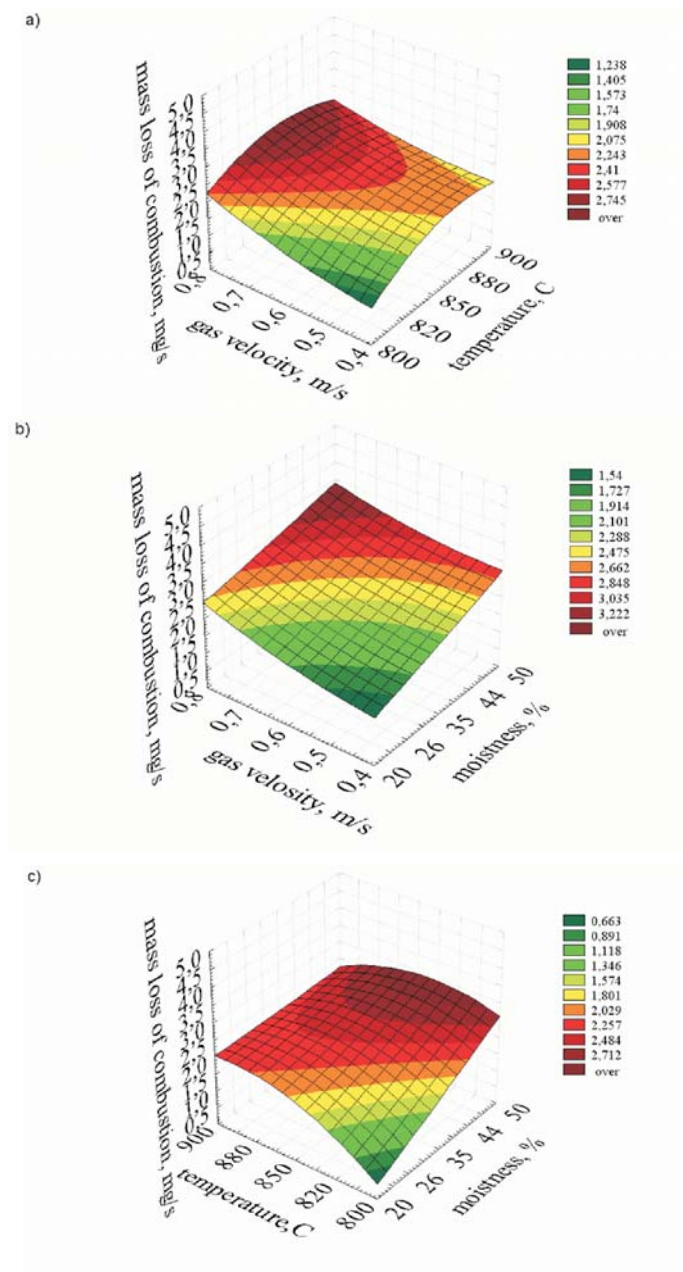

Figure 10. Relation between: a) temperature in the combustion chamber and gas velocity, b) gas velocity and moisture of suspension, c) temperature in the combustion chamber and moisture of suspension and the mass rate of fuel combustion during cyclic combustion $10s_A/10s_N$ (s_A/s_N – time combustion in air/time residence in nitrogen); hard coal dust (mine Sobieski): below $250 \mu\text{m}$.

bient was limited. The cyclic process of suspension consisted of repeated ignition and extinction of fuel which caused the slight shift of combustion in the kinetic direction. It was also found that the combustion transition to the kinetic area, in the case of the cyclic processes, was mainly caused by lowering of the mean fuel temperature. The reduction of the time, when the suspension was subjected to the oxidizing atmosphere, within one periodic cycle, led to the slight reduction of combustion rate [14]. The smaller changes of the mass combustion rate, which were related to the temperature increase, proved that the continuous combustion of suspension in the experimental conditions took place in the transitory area, where the diffusion processes dominated. It is generally known that in the combustion transitory area, the chemical reaction rate and the rate of diffusion into the pores are comparable with each other. It caused the limited oxygen penetration into char, whereas the pores close to the external coal particle surface absorbed majority of oxygen. The observed stronger impact of temperature on the coal-water suspension combustion rate, in the case of the cyclic process, indicated a slight shift of the process into the area controlled by chemical reactions kinetics. The decrease of temperature in the combustion chamber led to the shift of the process into the more kinetic area. The increase of the gas-flow velocity caused evident increase of the fuel combustion, in the case of the continuous process. Combustion process reaction on the kinetic and diffusion factors confirmed the view that coal-water suspension combustion carried out during the experiments took place in the transitory area and the process was determined by both the oxygen diffusion into the reaction surface and the chemical kinetics. Another element of the research was to determine the combustion course of the coal-water suspensions of various types (with moisture of 35%) in the air stream and in the fluidized bed condition (Figs. 11–15), performed on the research stand (Figs. 3 and 4). During the combustion in the fluidized bed all coal-water suspensions are characterized by longer combustion time in comparison to the combustion in the air stream. The longest combustion time was recorded during the examination of suspension made of anthracite dust and the shortest one for the suspension made with the brown dust. The inert material during the combustion in a fluidized bed takes away the heat from the suspension. The removal of heat causes temperature lowering of the fuel which results in the total time of the process.

Figures 16–19 present an example of temperature changes of coal-water suspension during its continuous and cyclic combustion, both in air and in

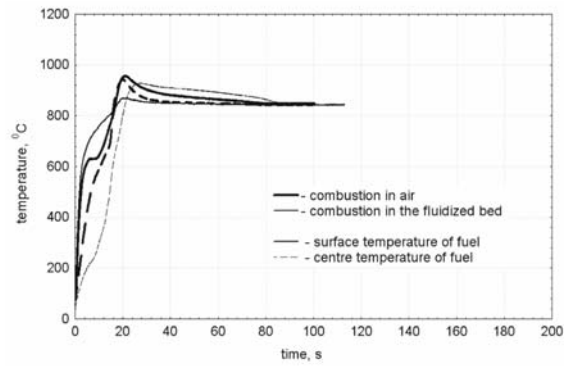

Figure 11. An example of temperature changes of brown coal-water suspension during its continuous combustion in air and in the fluidized bed.

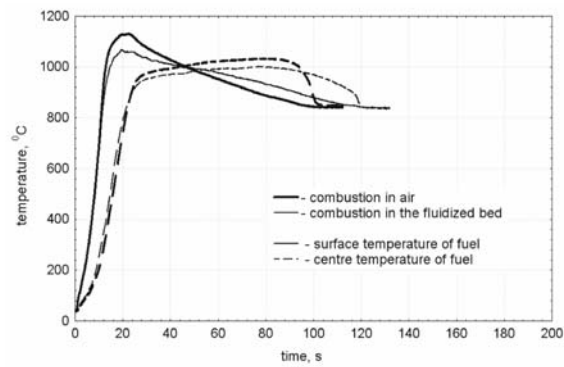

Figure 12. An example of temperature changes of hard coal-water suspension (Sobieski mine) during its continuous combustion in air and in the fluidized bed.

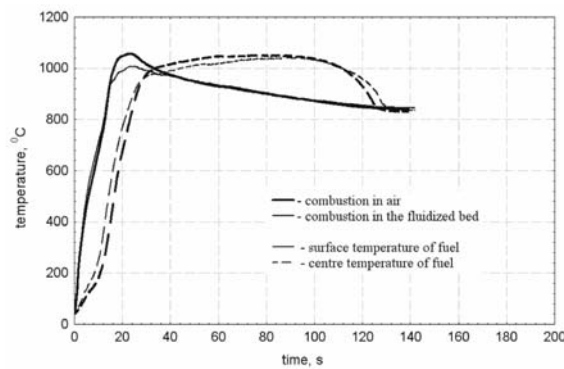

Figure 13. An example of temperature changes of mixture (50%/50%) of hard coal and coal slurry-water suspension (Sobieski mine) during its continuous combustion in air and in the fluidized bed.

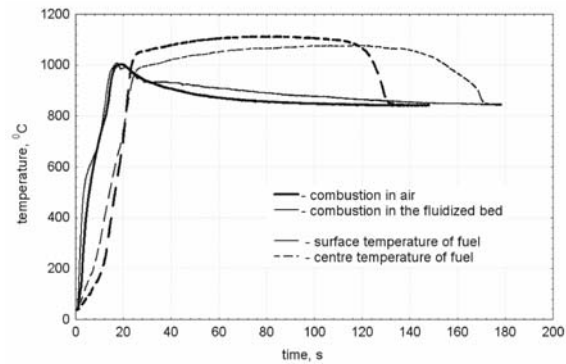

Figure 14. An example of temperature changes of hard coal-water suspension (Staszic mine) during its continuous combustion in air and in the fluidized bed.

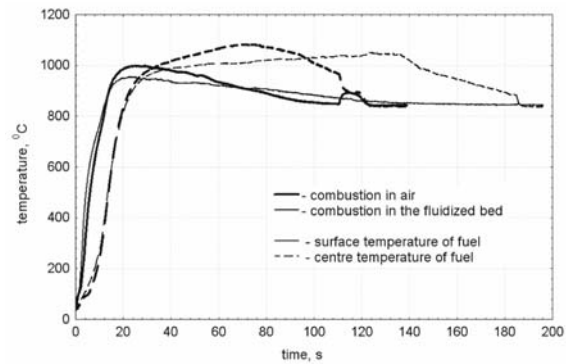

Figure 15. An example of temperature changes of anthracite-water suspension during its continuous combustion in air and in the fluidized bed.

the fluidized bed. Investigations were carried out as part of project [14], on the research stand (Figs. 3 and 4). The parameters of research were: moisture content in suspension, temperature in combustion chamber, gas velocity and slurry of coal (coal mule) content in suspension. Tables 2–5 presents the influence of parameters on combustion time.

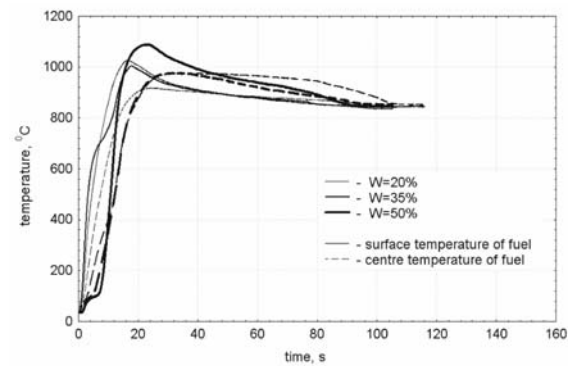

Figure 16. An example of temperature changes of coal*-water suspension during its continuous combustion in air.
 * the mixture 50%/50% of hard coal and coal slurry (Sobieski mine),
 W – moisture content, %.

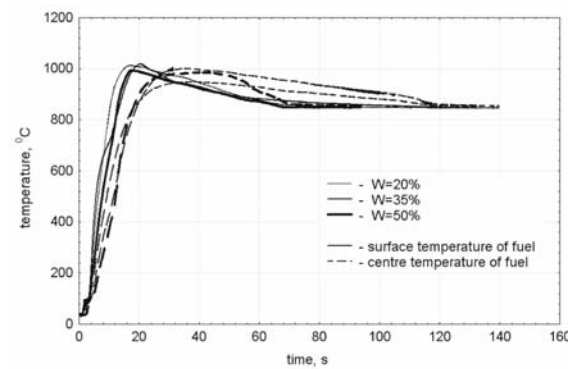

Figure 17. An example of temperature changes of coal*-water suspension during its continuous combustion in the fluidized bed.
 * the mixture 50%/50% of hard coal and coal slurry (Sobieski mine)

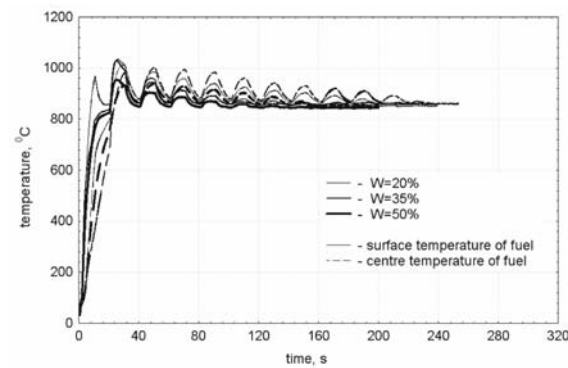

Figure 18. An example of temperature changes of coal*-water suspension during its cyclic combustion in air ($10s_A/10s_N$).
 * the mixture 50%/50% of hard coal and coal slurry (Sobieski mine)

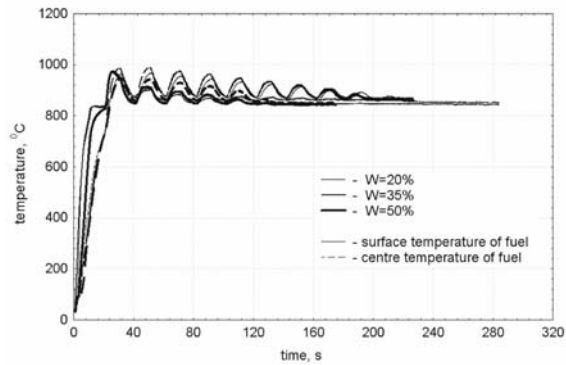

Figure 19. An example of temperature changes of coal*-water suspension during its cyclic combustion in the fluidized bed ($10s_A/10s_N$).

* the mixture 50%/50% of hard coal and coal slurry (Sobieski mine)

Table 2. Influence of process parameters on coal-water suspension combustion in air.

Increase of parameter	Influence on combustion time
Moisture content in suspension	decrease
Temperature in combustion chamber	decrease
Gas velocity	decrease
Slurry content in suspension	increase

Table 3. Influence of process parameters on coal-water suspension combustion in the fluidized bed.

Increase of parameter	Influence on combustion time
Moisture content in suspension	decrease
Temperature in combustion chamber	decrease
Gas velocity	decrease
Slurry content in suspension	increase

During the combustion of coal-water suspension in the fluidized bed one can observe the increase of the suspension porosity. The pores are usually filled up on the surface with the particles adhering in the inert material (Fig. 20). Therefore, the coal-water suspension combustions are more intense in the air stream. In these conditions the combustion temperature

Table 4. Influence of process parameters on coal-water suspension cyclic combustion ($10s_A/10s_N$) in air.

Increase of parameter	Influence on combustion time
Moisture content in suspension	decrease
Temperature in combustion chamber	decrease
Gas velocity	lack of influence
Slurry content in suspension	increase

Table 5. Influence of process parameters on coal-water suspension cyclic combustion ($10s_A/10s_N$) in the fluidized bed.

Increase of parameter	Influence on combustion time
Moisture content in suspension	decrease
Temperature in combustion chamber	decrease
Gas velocity	lack of influence
Slurry content in suspension	increase

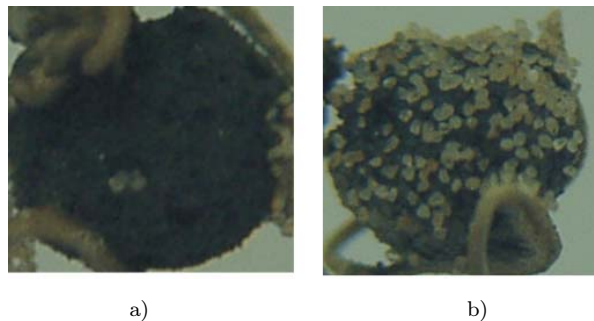
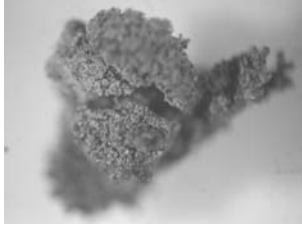





Figure 20. Coal-water suspension during combustion in the fluidized bed; moisture of suspension: a) 25%, b) 45%, after 45 s of the process.

is higher, which in consequence influences the combustion time shortening. The cyclic change of the oxygen concentration around fuel leads to the increase of the suspension porosity, too (Tab. 6).

Table 6. Comparison of ash of coal-water suspension after continuous and cyclic combustion.

Type of combustion	Combustion in air	Combustion in the fluidized bed
Continuous		
Cyclic		

4 Mathematical model of cyclic combustion of coal-water suspension

Apart from the research experiments, it is important to thoroughly analyze the physical and chemical phenomena, occurring during the coal-water suspension combustion as well as to competently describe the mathematical relationships between them. In the so far worked out mathematical models, there have been attempts to find the equations on the basis of which from the well known initial conditions one could forecast the course of the phenomenon, i.e. to determine the coal-water suspension combustion velocity, the flowing exhaust content or the local concentration of their components. It was interesting to determine the surface and centre temperature of suspension. The previous research experiments and mathematical modelling of the suspension fuel combustion do not take into consideration the cyclic, interrupting process, characteristic for the CFB combustion. In the present paper a model of coal-water suspension combustion was offered with the assumption of the alternate fuel lighting and extinguishing, at various time intervals.

General model assumptions

During the model realization were assumed the basic data characteristic for the process of the coal-water suspension combustion, i.e. the coal-water suspension mass and temperature change. The model formulation required to accept the following assumptions [14]:

- coal-water suspension possesses a homogeneous structure and does not undergo fragmentation during the combustion process,
- coal-water suspension has a spherical shape of a known radius R which does not change during the process,
- combustion of coal-water suspension is held according to the model of “contracting core” which leads to the isolation of suspension center through the growing ash layer,
- suspension density does not depend on temperature,
- process is held since the fuel is introduced to the combustion chamber to finish combustion;

in the case of the cyclic combustion

- coal-water suspension is extinguished in the presence of nitrogen flow,
- environment temperature of coal-water suspension during its alternate lighting and extinguishing does not change,
- the cyclic property is described by two-state function:

$$f(\tau) = \begin{cases} \text{"air"} & \text{for } \tau \in [0, \tau_A) , \\ \text{"nitrogen"} & \text{for } \tau \in [\tau_A, \tau_N) , \end{cases}$$

where: $0-\tau_A$ – the time period when air is given, and $\tau_A-\tau_N$ – the time period when nitrogen is introduced to the combustion chamber;

in the case of combustion in the fluidized bed

- after the coal-water suspension introduction to the combustion chamber it is covered with the particles of inert material and additionally the fuel surface erosion takes place. This is due to the collision with particles of the bed material [14,15].

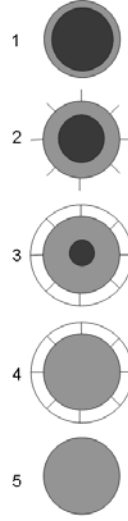

Figure 21. Stages of coal-water suspension combustion: 1 – evaporation of water from suspension surface; 2 – continuation of water evaporation from inside suspension, devolatilisation of volatiles matter from suspension surface; 3 – continuation of evaporation and devolatilisation of volatiles matter from inside suspension, combustion of volatiles matter; 4 – combustion of volatiles matter near suspension surface and char agglomerate combustion; 5 – continuation of combustion of char agglomerate.

The course of ignition and combustion of coal-water suspension drops are determined by water evaporation, devolatilization process and coal combustion (Fig. 21).

In order to calculate temperature changes of coal-water suspension drops the Fourier-Kichhoff equation was used:

$$c(T) \rho(T) \frac{\partial T(r, \tau)}{\partial \tau} = \frac{1}{r^2} \frac{\partial}{\partial r} \left[r^2 \lambda(T) \frac{\partial T(r, \tau)}{\partial r} \right] + q_V(r, \tau) . \quad (3)$$

Calculations were carried out by means of the Control Volume Method [14]. Discretisation of area geometry was shown in Fig. 22. The following relationship was accepted:

$$\Delta r = \frac{R}{N} , \quad (4)$$

where:

- N – number of discretisation periods,
- r_i – nodes on radius ($r_0 = 0$, $r_i = i\Delta r$, $r_N = N\Delta r = R$),
- ΔV_i – volumes of sub-areas.

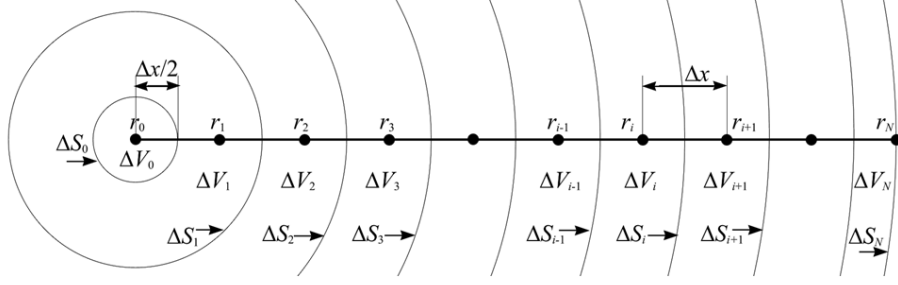

Figure 22. Discretisation of fuel area.

The following boundary conditions were accepted:

- for n (outer) cell – the boundary condition of the third type:

$$\dot{q} = -\lambda \frac{\partial T(r, \tau)}{\partial r} \Big|_{r=R} = \alpha [T(R, \tau) - T_{ot}(\tau)] , \quad (5)$$

- for 0 (inner) cell – the boundary condition of the second type:

$$\frac{\partial T(r, \tau)}{\partial r} \Big|_{r=0} = 0 . \quad (6)$$

As a result of calculations the following relationships were obtained:

- for $i = 1, \dots, N - 1$:

$$T_i^{f+1} = T_i^f + \frac{\Delta \tau}{c_i^f \rho_i^f} \left[\lambda_{i,i+1}^f \frac{\Delta S_i}{\Delta V_i \Delta r} (T_{i+1}^f - T_i^f) + \lambda_{i,i-1}^f \frac{\Delta S_{i-1}}{\Delta V_i \Delta r} (T_{i-1}^f - T_i^f) + q_{V_i}^f \right] , \quad (7)$$

- dla $i = N$:

$$T_N^{f+1} = T_N^f + \frac{\Delta t}{c_N^f \rho_N^f} \left[\alpha \frac{\Delta S_N}{\Delta V_N} (T_{ot}^f - T_N^f) + \lambda_{N,N-1}^f \frac{\Delta S_{N-1}}{\Delta V_N \Delta r} (T_{N-1}^f - T_N^f) + q_{V_N}^f \right] , \quad (8)$$

- dla $i = 0$:

$$T_0^{f+1} = T_0^f + \frac{\Delta \tau}{c_0^f \rho_0^f} \left[\lambda_{0,1}^f \frac{\Delta S_0}{\Delta V_0 \Delta r} (T_1^f - T_0^f) + q_{V_0}^f \right] . \quad (9)$$

According to the experimental observation, it was accepted that immediately after introduction of the suspension to the fluidized bed, the quartz sand particles stick to the surface of suspension which leads to the initial increase of the fuel mass by the inertia mass. It, of course, does not take part in the process of combustion of suspension (the phenomenon of adhering to the surface depends on the type of coal, humidity and air flow velocity) [14,15]. The phenomenon of “adhering to the surface” mainly takes place during fuel evaporation and devolatilization. The examined model refers to two aspects of combustion in a fluidized bed: the process of fuel combustion and the erosion process, which is the result collisions of the material of bed with surface suspension. Sherwood’s number is accepted depending on the character of the suspension flow by the fluidizing bed material (Fig. 23) [14,15].

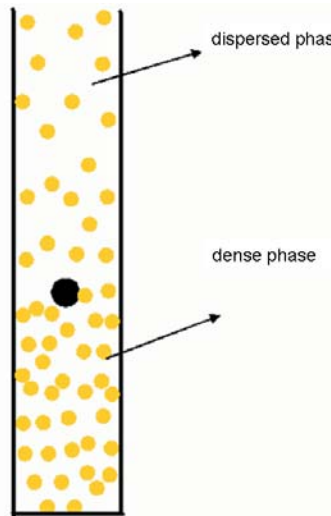

Figure 23. Subregions in the fluidized bed.

Below are shown the numerically calculated centre and surface temperature changes and mass loss of coal-water suspension examined in the combustion conditions (Figs. 24–35). On the basis of the shown analysis one can state that the curves calculated from the model with satisfactory precision, describe the combustion process carried out during the research experiments. The combustion time of coal-water suspension gets longer, when the fixed carbon content in the fuel rises. The cyclical nature of combustion leads to the lowering of the medium process temperature.

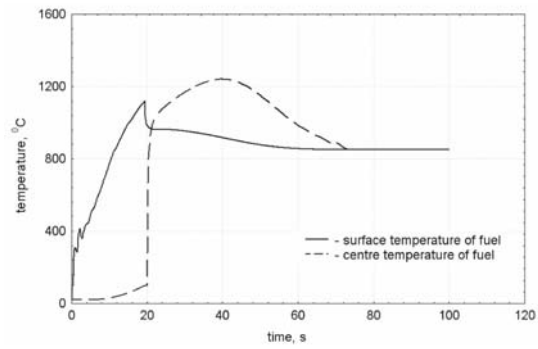

Figure 24. Numerically calculated surface and centre temperatures of a brown coal-water suspension during continuous combustion in air.

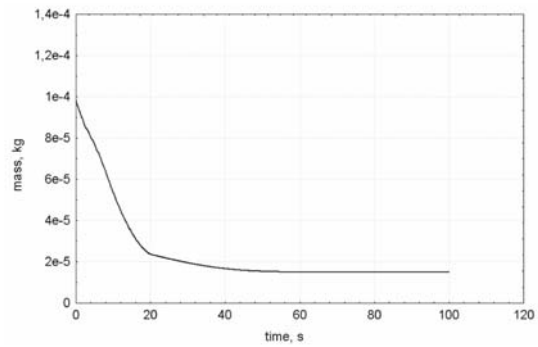

Figure 25. Numerically calculated mass loss of a brown coal-water suspension during continuous combustion in air.

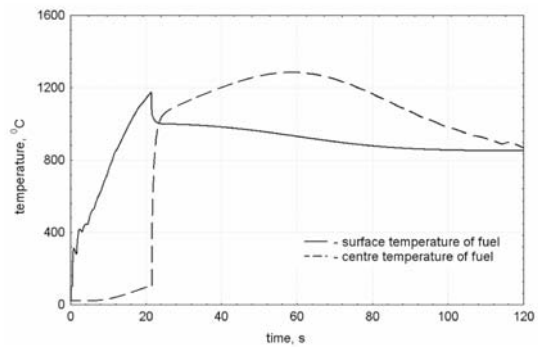

Figure 26. Numerically calculated surface and centre temperatures of a hard coal-water suspension (Sobieski mine) during continuous combustion in air.

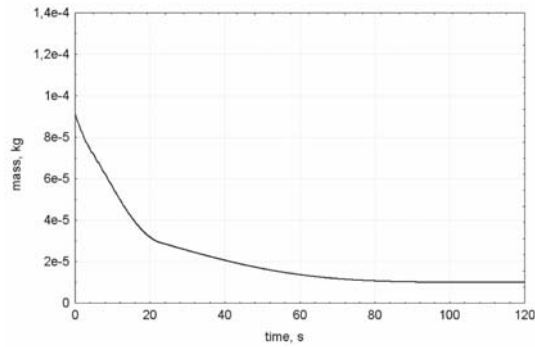

Figure 27. Numerically calculated mass loss of a hard coal-water suspension (Sobieski mine) during continuous combustion in air.

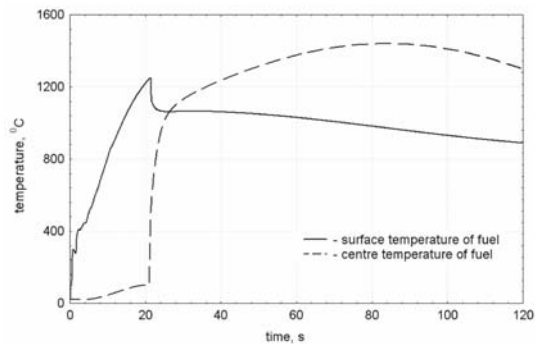

Figure 28. Numerically calculated surface and centre temperatures of an anthracite-water suspension during continuous combustion in air.

Specificity of the coal-water suspension combustion in a fluidized bed changes the character of mass and heat exchange between the fuel and the environment. In the conditions of a fluidized bed, at the initial combustion stage, the fuel heats faster (due to its strike with the heated material of bed) but further intensive heat exchange between the fuel and the material of bed leads to the lowering of the medium temperature of coal-water suspension (due to the fact that the flowing inert material took the heat from the suspension surface). The erosion process leads to intensive suspension mass loss to the final value which is below the initial ash mass.

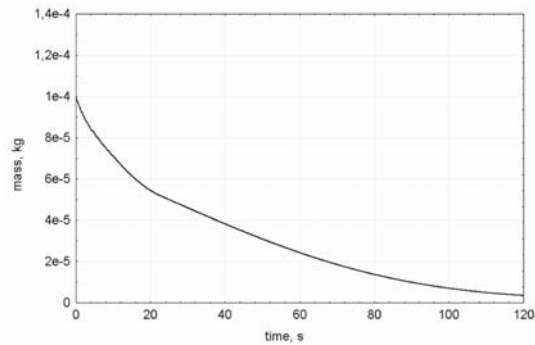

Figure 29. Numerically calculated surface and centre temperatures of a anthracite-water suspension during continuous combustion in air.

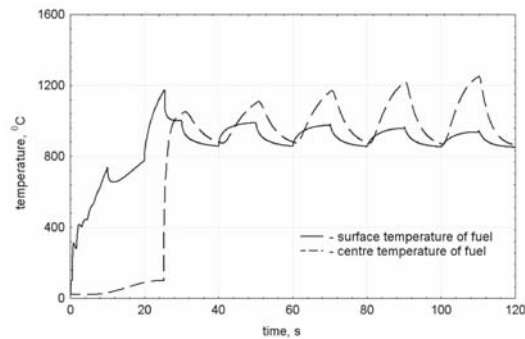

Figure 30. Numerically calculated surface and centre temperatures of a hard coal-water suspension (Sobieski mine) during cyclic combustion $10s_A/10s_N$ (s_A/s_N – time combustion in air/time residence in nitrogen).

5 Conclusions

The research results presented in the paper and the theoretical analyses considering the cyclic change of oxygen concentration around the coal-water suspension, allowed to formulate the following conclusions:

1. Different moisture share in the coal-water suspension leads to the change in both the mechanism and kinetics of combustion.
2. The combustion process of a suspension fuel drop in the air stream, occurring in the temperature range of 800–900 °C takes place in the transitory area with the majority of diffusive factors.
3. After the ignition of evaporated and devolatilized agglomeration of

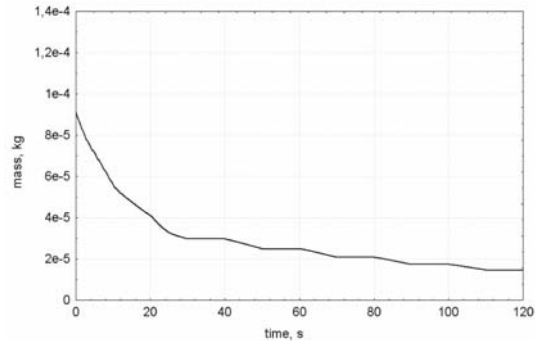

Figure 31. Numerically calculated mass loss of a hard coal-water suspension (Sobieski mine) during cyclic combustion $10s_A/10s_N$ (s_A/s_N – time combustion in air/time residence in nitrogen).

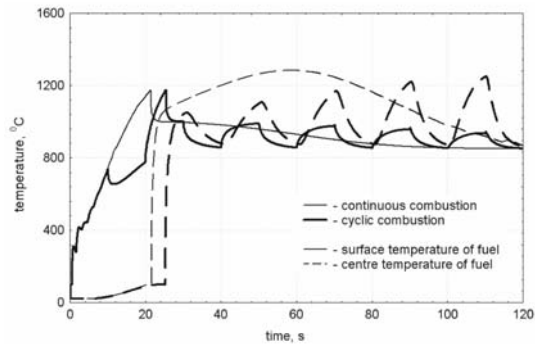

Figure 32. Comparison between numerically calculated surface and centre temperatures of a hard coal-water suspension (Sobieski mine) during continuous (in air) and cyclic combustion $10s_A/10s_N$ (s_A/s_N – time combustion in air/time residence in nitrogen).

suspension fuel, one can observe the intensive increase of coal-water suspension temperature to the maximum value.

4. During combustion in the conditions of fluidized bed, one can observe the intensive fuel heating in the initial stage of the process and then the heat is taken from the coal-water suspension by the hitting the inert material. It leads to the lowering of the medium fuel temperature and to the slight extension of its combustion time.
5. The cyclic change of oxygen concentration around the burning suspension fuel leads to the lowering of the fuel medium temperature

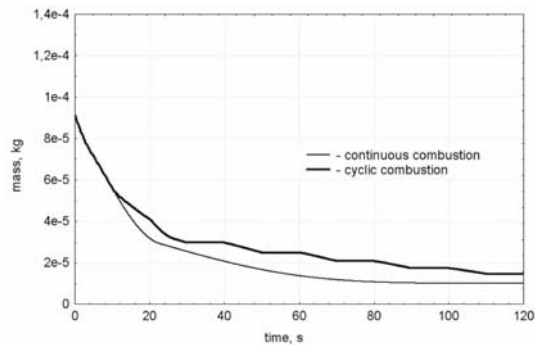

Figure 33. Comparison between numerically calculated mass loss of a hard coal-water suspension (Sobieski mine) during continuous (in air) and cyclic combustion $10s_A/10s_N$ (s_A/s_N – time combustion in air/time residence in nitrogen).

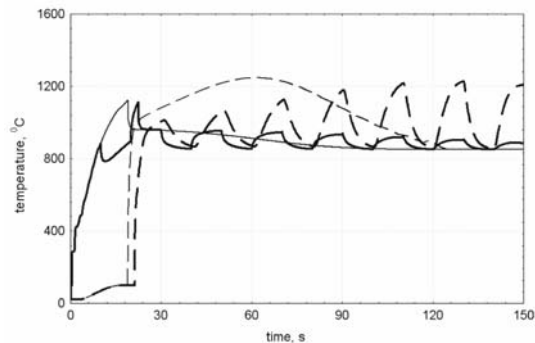

Figure 34. Comparison between numerically calculated surface and centre temperatures of a hard coal-water suspension (Sobieski mine) during continuous and cyclic combustion $10s_A/10s_N$, in the fluidized bed (s_A/s_N – time combustion in air/time residence in nitrogen).

and to the changes of combustion mechanism, moving it slightly in the kinetic direction.

6. The worked out mathematical model contains the equations considering all phenomena accompanying the suspension fuel combustion in various conditions: in the air stream, at the alternate fuel lighting, extinguishing and in the conditions of fluidized bed. The suggested model describes with the sufficient precision the above mentioned processes, that take place during the research experiments.

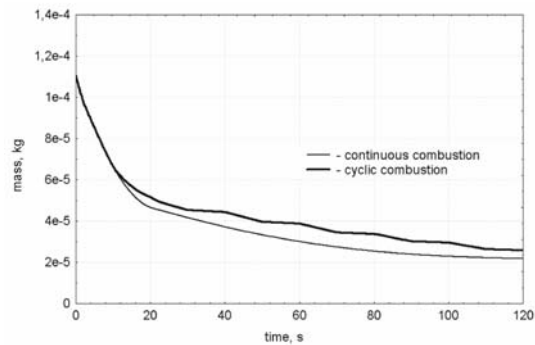

Figure 35. Comparison between numerically calculated mass loss of a hard coal-water suspension (Sobieski mine) during continuous and cyclic combustion $10s_A/10s_N$, in the fluidized bed (s_A/s_N – time combustion in air/time residence in nitrogen).

Acknowledgements The work was financed from the budget on science in 2005–2008 years as research project.

Received 31 March 2010

References

- [1] GAJEWSKI W., KIJO-KLECKOWSKA A., LESZCZYŃSKI J.: *Analysis of cyclic combustion of solid fuels*. Fuel **88**(2009), 221–234.
- [2] ATEKOK G., BOYLU F., SIKECI A.A., DINCER H.: *The effect of coal properties on the viscosity of coal-water slurries*. Fuel **81**(2002), 1855–1858.
- [3] BOYLU F., DINCER H., ATEKOK G.: *Effect of coal particle size distribution, volume fraction and rank on the rheology of coal-water*. Fuel Processing Technology (2004), 241–250.
- [4] BURDUKOV A.P., POPOV V.I., TOMILOV V.G.: *The rheodynamics and combustion of coal-water mixtures*. Fuel **81**(2002), 927–933.
- [5] LIU G.E., LAW C.K.: *Combustion of coal-water droplets*. Fuel **65**(1986), 171–176.
- [6] DUNN-RANKIN D., HOORNSTRA J., GRUELICH F.A., HOLVE J.: *Combustion of coal-water slurries. Evolution of particle size distribution for coals of different rank*. Fuel **66**(1987), 1139–1145.
- [7] CHAN K.K.: *Pilot-scale combustion tests on coal-water mixtures with reference to particle agglomeration*. Fuel **73**(1994), 1632–1637.
- [8] ŚLĄCZKA A.: *Coal-water suspensions on the basis of coke-coals and energy-coals*. Scientific Books of Silesian Technical University. Mining Engineering **231**(1996), 499–511 (in Polish).

-
- [9] HYCINAR J.: *Liquid coal fuel: coal-water suspensions*. Mining Messages **2**(2001), 63–68 (in Polish).
- [10] WANDRASZ J.W., NADZIAKIEWICZ J.: *Fuels from wastes*, Vol. III. Gliwice 2001 (in Polish).
- [11] NADZIAKIEWICZ J., KOZIOŁ M.: *Co-combustion of sludge with coal*. Applied Energy **75**(2003), 239–248.
- [12] Kubica R., Smółka W.: *Coal suspensions. Development, characterization and use perspectives*. Management of Fuels and Energy **1**(2000), 2–8 (in Polish).
- [13] POLAŃSKI R.: *Planning of Experiments in Technics*. PWN, Warsaw 1984 (in Polish).
- [14] GAJEWSKI W.: *Analysis of combustion processes of coal-water suspensions in the fluidized bed*. Report of research project 2005–2008 (in Polish).
- [15] KIJÓ-KLECZKOWSKA A.: *Combustion of coal-water suspensions*. Fuel **90**(2011) 2, 865–877.