

Modeling of voice data integrated traffic in 3G mobile cellular network

Imdadul Islam, Jugal Krishna Das, and Siddique Hossain

Abstract— The most important feature of 3G mobile cellular network is introduction of voice data integrated service under multilayered cell environment to support overflow traffic of lower layered cells by upper ones. This paper deals with traffic model of three layered cells, i.e., micro cell, macro cell and satellite cell. Here a new call admission control is introduced for three layered cell of 3G mobile cellular network. State transition chain is designed for theoretical analysis of above mentioned traffic. Blocking probability of data call, new voice call and handover failure of voice call, probability of utilization of micro cell channel, macro cell channel and satellite cell channel are analyzed against different traffic parameters and yield logical results.

Keywords—3G mobile, voice data integrated service, micro cell, macro cell, satellite cell, Markovian chain and thinning scheme.

1. Introduction

Mobile cellular communication system is the most rapidly changing technology in the field of telecommunications. The coverage area of mobile cellular network has been expanded from urban micro cell to indoor pico cell. As the mobile cellular network moves towards 3G technology, one of the objectives is the use of single wireless system to support a variety of services including voice, data and voice in various forms mentioned in [1, 2]. The 3G mobile technology had combined both satellite and terrestrial networks together, and three- or four-layer cell structure (several micro cells are overlaid by a macro cell and again few macro cells are overlaid by a big satellite cell) is provided to combat network congestion summarized in [3–5]. Channel assign-

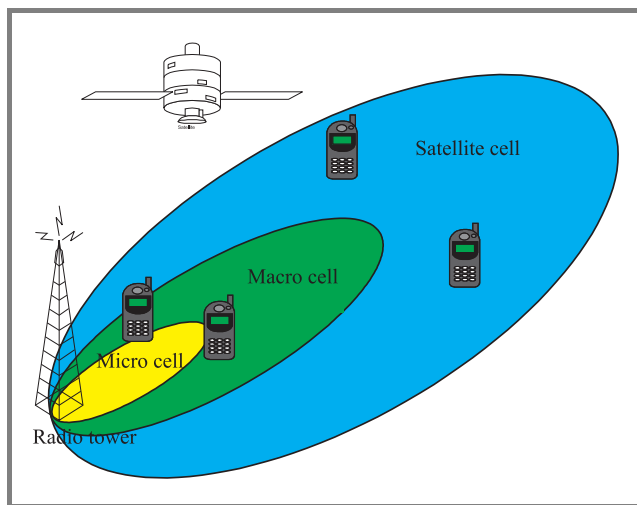

Fig. 1. Multilayer cell structure of 3G system (IMT-2000).

ment and power control is really a cumbersome job for this type of cell configuration, but power control part is beyond the scope of this paper; the authors analyze here only channel allocation. Usually in multilayered cell any new arrival will first search for a channel from micro cell and will route to macro cell in case of unavailability of free channel in a given micro cell. A call will only route to satellite cell if both micro and macro cells are found occupied. If any call continuing in macro or satellite cell finds free channel in micro cell, it will take-back [6] to that micro cell; take-back might take place even between satellite cell and macro cell. Multilayer cell architecture of 3G system is shown in Fig. 1 for three layer cell structure, where any mobile station (MS) can make intra system handover from one layer to another depending on its mobility.

Section 2 of the paper deals with overflow traffic of three layered cell in generalized form and we call it composite traffic model. Section 3 presents the proposed call admission control scheme, while Subsection 3.1 implements the traffic model of Section 3 based on Markovian chain and mathematical expressions of data, new voice call and handover voice call blocking probability are derived. Section 4 depicts the results graphically for different traffic parameters. In this paper we ignored the take-back phenomenon in our new call admission scheme for simplicity of analysis; of course, the take-back is included in composite traffic mode of Section 2.

2. Composite traffic model

Here overlaid cell carries overflow traffic from underlain cell. At the same time take-back alleviates overloading of any upper layer cell in order to reduce blocking probability. State transition diagram for three layer cell structure of Fig. 1 is shown in Fig. 2, where number of channel of micro cell is n , that of macro cell is m and that of satellite cell is k . Few states are unreachable here, like [7, 8] due to the take-back phenomenon. These states are marked by crosses in Fig. 2.

Here:

μ_1 – termination rate of micro cell,

μ_2 – termination rate of macro cell,

μ_3 – termination rate of satellite cell,

λ – average arrival rate of new or handoff call on any cell.

Solution of the Markovian chain yields following equations using cut equations of [9, 10] and [18, 19]. Probability of

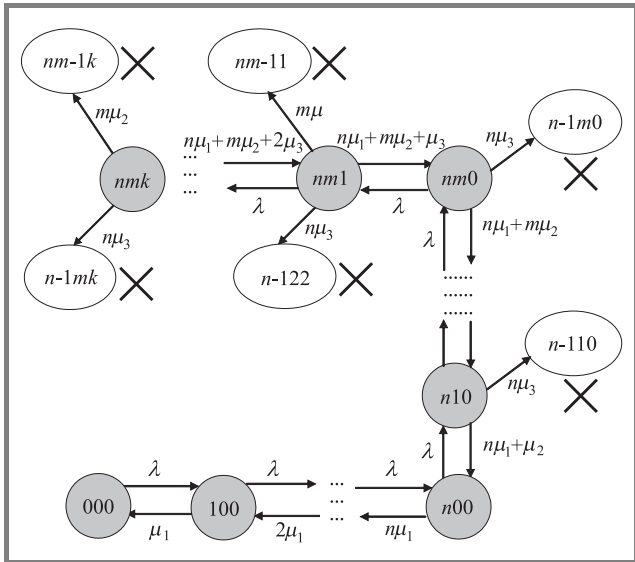

Fig. 2. Markov chain of three layer cell structure.

utilization of micro cell channel taking equal termination rate, $\mu_1 = \mu_2 = \mu_3 = \mu$ and $A = \lambda / \mu$ is derived like:

$$\begin{aligned}
 & Mi(m) \\
 &= \frac{\sum_{i=0}^n \frac{A^i}{i!}}{\sum_{i=0}^n \frac{A^i}{i!} + \frac{A^n}{n!} \sum_{j=1}^m \frac{A^j}{\prod_{s=1}^j (n+s)} + \frac{A^{n+m}}{n! \prod_{i=1}^m (n+i)} \sum_{t=1}^k \frac{A^t}{\prod_{z=1}^t (r+z)}}, \tag{1}
 \end{aligned}$$

where $r = m + n$. Probability of utilization of macro cell channel is defined by the following formula:

$$\begin{aligned}
 & Ma(m) \\
 &= \frac{\frac{A^n}{n!} \sum_{j=1}^m \frac{A^j}{\prod_{s=1}^j (n+s)}}{\sum_{i=0}^n \frac{A^i}{i!} + \frac{A^n}{n!} \sum_{j=1}^m \frac{A^j}{\prod_{s=1}^j (n+s)} + \frac{A^{n+m}}{n! \prod_{i=1}^m (n+i)} \sum_{t=1}^k \frac{A^t}{\prod_{z=1}^t (r+z)}}. \tag{2}
 \end{aligned}$$

And the probability of utilization of satellite cell channel is

$$\begin{aligned}
 & Sa(m) \\
 &= \frac{\frac{A^{n+m}}{n! \prod_{i=1}^m (n+i)} \sum_{t=1}^k \frac{A^t}{\prod_{z=1}^t (r+z)}}{\sum_{i=0}^n \frac{A^i}{i!} + \frac{A^n}{n!} \sum_{j=1}^m \frac{A^j}{\prod_{s=1}^j (n+s)} + \frac{A^{n+m}}{n! \prod_{i=1}^m (n+i)} \sum_{t=1}^k \frac{A^t}{\prod_{z=1}^t (r+z)}}. \tag{3}
 \end{aligned}$$

Call blocking probability equal is

$$\begin{aligned}
 & B(m) \\
 &= \frac{\frac{A^{m+n+k}}{n! \prod_{i=1}^m (n+i)} \sum_{t=1}^k (r+t)}{\sum_{i=0}^n \frac{A^i}{i!} + \frac{A^n}{n!} \sum_{j=1}^m \frac{A^j}{\prod_{s=1}^j (n+s)} + \frac{A^{n+m}}{n! \prod_{i=1}^m (n+i)} \sum_{t=1}^k \frac{A^t}{\prod_{z=1}^t (r+z)}}. \tag{4}
 \end{aligned}$$

3. New call admission control scheme

In the previous section we did not distinguish between data and voice traffic where call arrival rate λ is simply ruled by Poisson's distribution. Arrivals include data call, new voice call and voice handover call. In this call admission scheme we put emphasis on voice traffic rather than data traffic. Here both data and voice traffic share channels of a micro cell. Any data arrival beyond the capacity of micro cell will be blocked, but overflow voice traffic will be supported by the overlaid macro cell.

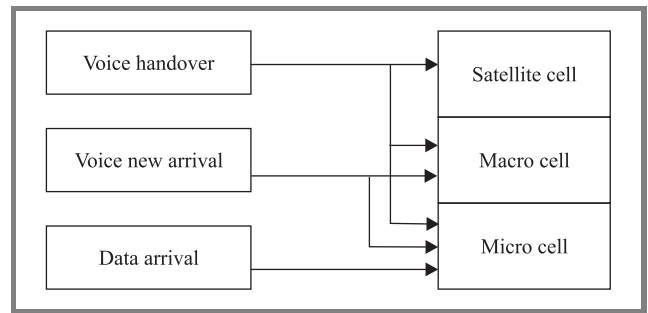

Fig. 3. Proposed call admission control.

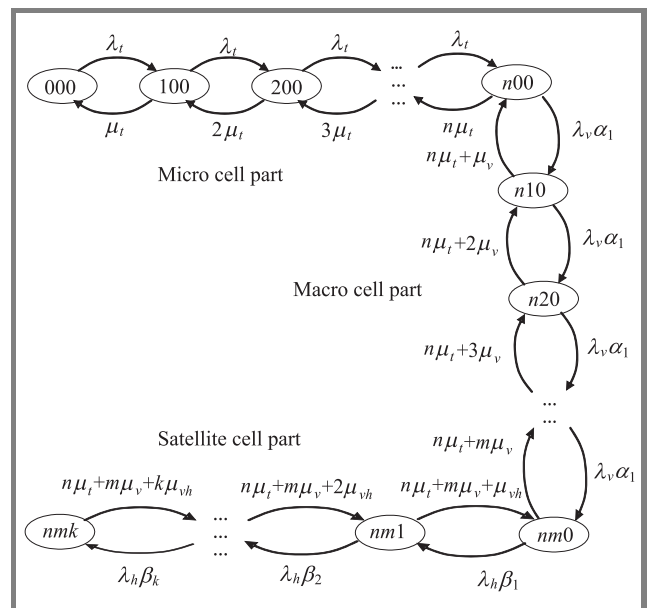

Fig. 4. State transition chain of the proposed scheme.

$$Bd(n, m, k) = \frac{\sum_{i=n}^n \frac{A_t^i}{i!}}{\sum_{i=0}^n \frac{A_t^i}{i!} + \frac{A_t^n}{n!} \sum_{s=1}^m \frac{\lambda_v^s \prod_{i=1}^s \alpha_i}{\prod_{j=1}^s (n\mu_t + j\mu_v)} + \frac{\lambda_v^m \prod_{i=1}^m \alpha_i}{\prod_{j=1}^m (n\mu_t + j\mu_v)} \frac{A_t^n}{n!} \sum_{r=1}^k \frac{\lambda_h^r \prod_{j=1}^r \beta_j}{\prod_{i=1}^r (n\mu_t + m\mu_v + i\mu_{vh})}} \quad (5)$$

$$V(n, m, k) = \frac{\frac{A_t^n}{n!} \sum_{s=m}^m \frac{\lambda_v^s \prod_{i=1}^s \alpha_i}{\prod_{j=1}^s (n\mu_t + j\mu_v)}}{\sum_{i=0}^n \frac{A_t^i}{i!} + \frac{A_t^n}{n!} \sum_{s=1}^m \frac{\lambda_v^s \prod_{i=1}^s \alpha_i}{\prod_{j=1}^s (n\mu_t + j\mu_v)} + \frac{\lambda_v^m \prod_{i=1}^m \alpha_i}{\prod_{j=1}^m (n\mu_t + j\mu_v)} \frac{A_t^n}{n!} \sum_{r=1}^k \frac{\lambda_h^r \prod_{j=1}^r \beta_j}{\prod_{i=1}^r (n\mu_t + m\mu_v + i\mu_{vh})}} \quad (6)$$

$$HF(n, m, k) = \frac{\frac{\lambda_v^m \prod_{i=1}^m \alpha_i}{\prod_{j=1}^m (n\mu_t + j\mu_v)} \frac{A_t^n}{n!} \sum_{r=k}^k \frac{\lambda_h^r \prod_{j=1}^r \beta_j}{\prod_{i=1}^r (n\mu_t + m\mu_v + i\mu_{vh})}}{\sum_{i=0}^n \frac{A_t^i}{i!} + \frac{A_t^n}{n!} \sum_{s=1}^m \frac{\lambda_v^s \prod_{i=1}^s \alpha_i}{\prod_{j=1}^s (n\mu_t + j\mu_v)} + \frac{\lambda_v^m \prod_{i=1}^m \alpha_i}{\prod_{j=1}^m (n\mu_t + j\mu_v)} \frac{A_t^n}{n!} \sum_{r=1}^k \frac{\lambda_h^r \prod_{j=1}^r \beta_j}{\prod_{i=1}^r (n\mu_t + m\mu_v + i\mu_{vh})}} \quad (7)$$

Only the handover part of voice arrival will further be supported by satellite cell. The phenomenon mentioned above is shown in Fig. 3 based on concept presented in papers [11–13].

Channels of macro and satellite cells resemble the guard channel of handover call, hence probability of forced termination/handover failure will be reduced to minimum. The whole phenomenon is represented by state transition diagram of Fig. 4 like [14, 15] and equations of call blocking probability, probability of utilization of micro cell channel, macro cell channel and satellite cell channel are derived from cut equations of Markovian chain.

3.1. Traffic modeling

State transition diagram for call admission scheme of previous section is depicted in Fig. 4. As channels of macro and satellite cells are shared among several micro cells, the probability of getting free channel of macro and satellite cells will be gradually decreased, hence thinning scheme of [16, 17] is applicable to this traffic model.

Here:

λ_t – total call arrival rate of voice data integrated call,

μ_t – total termination rate of voice and data call,

λ_v – voice call arrival rate,

μ_v – termination rate of voice call,

λ_h – voice handover call arrival rate,

μ_{vh} – termination rate of voice handover call,

n – number of channels of micro cell,

m – number of channels of macro cell,

k – number of channels of satellite cell,

$\alpha_1 > \alpha_2 > \alpha_3 > \alpha_4 > \dots$ – probabilities of thinning scheme for micro cell,

$\beta_1 > \beta_2 > \beta_3 > \beta_4 > \dots$ – probabilities of thinning scheme for macro cell.

Solution of the Markovian chain yields the following equations using cut equations presented in [18,19].

Equations (5)–(7) shown at the top of this page define the following parameters:

- blocking probability of data call $Bd(n, m, k)$ – Eq. (5);
- blocking probability of new voice call $V(n, m, k)$ – Eq. (6);
- probability of handover failure of voice call $HF(n, m, k)$ – Eq. (7).

4. Results

Figure 5 shows graphs of Eqs. (1)–(4) plotted against number of channels. The graph reveals that probability of utilization of micro cell channel increases but that of macro and satellite cell channel decrease with rising number of

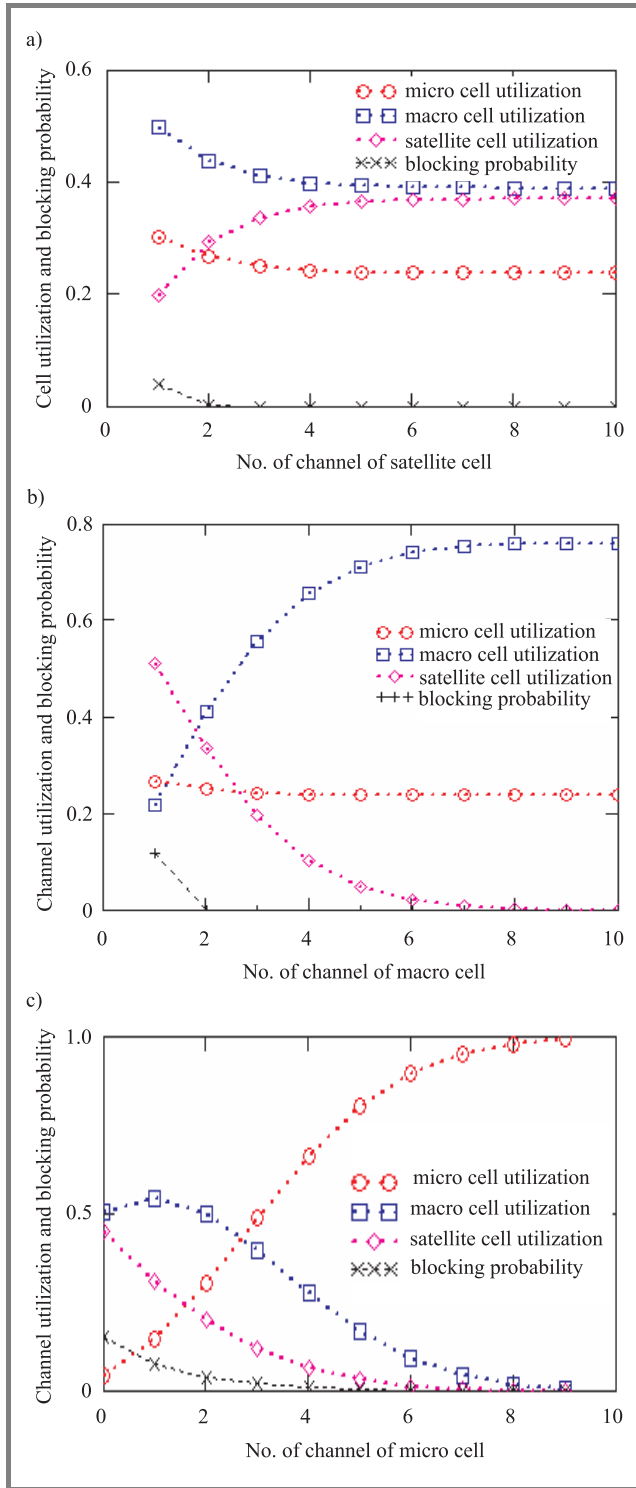

Fig. 5. Channel utilization and blocking probability for three different cases: (a) $n = 2, m = 2$; (b) $n = 2, k = 3$; (c) $m = 2, k = 1$.

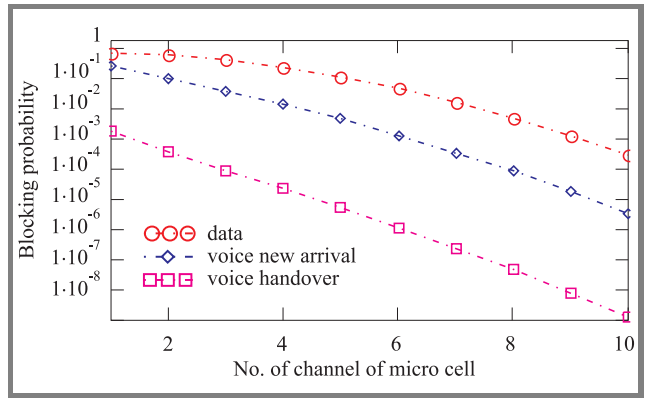

Fig. 6. Call blocking probability against channel of micro cell.

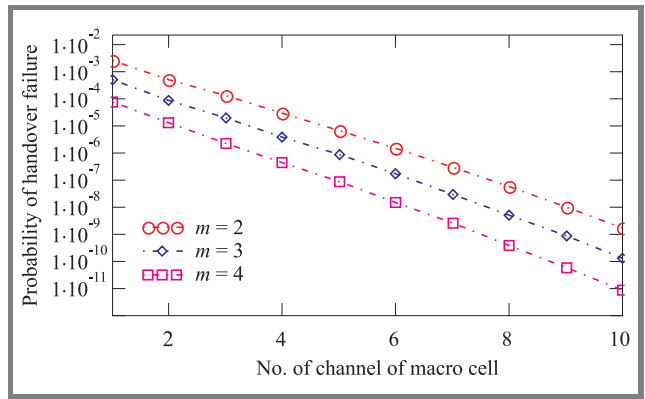

Fig. 7. Impact of number of macro cell channels on handover failure.

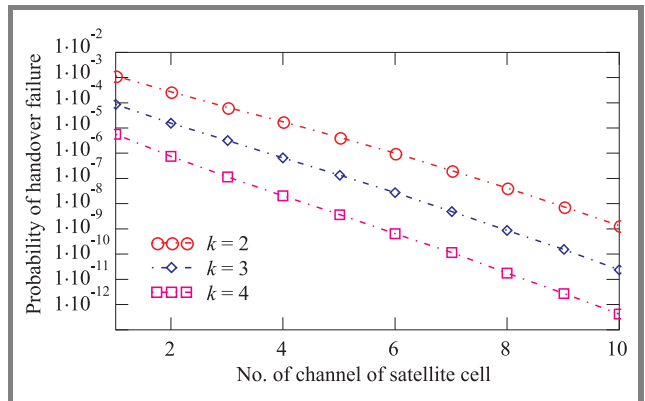

Fig. 8. Impact of number of satellite cell channels on handover failure.

micro cell channels. Again, probability of utilization of micro cell channel remains fixed, that of macro cell increases, but that of satellite cell channel decreases with increased number of macro cell channels. Probability of utilization of both micro and macro cell channel remains approximately constant, but that of satellite cell channel increases with increase in number of satellite cell channels k . Call blocking probability decreases for all three cases with increase in number of channels.

In our proposed call admission scheme the blocking probability of micro cell includes only blocking of data call, blocking of macro cell only covers new arrival part of voice call and finally blocking of satellite cell results in handover failure.

Effects of those phenomena are shown in Fig. 6, assuming: $\lambda_t = 10$ calls/min, $\mu_t = 4$ calls/min, $\lambda_v = 6$ calls/min, $\mu_v = 3$ calls/min, $\lambda_h = 1.2$ calls/min, $\mu_{vh} = 0.8$ calls/min, $\alpha_1 = 0.9$, $\alpha_2 = 0.8$, $\alpha_3 = 0.75$, $\alpha_4 = 0.7$, $\beta_1 = 0.9$, $\beta_2 = 0.8$, $\beta_3 = 0.75$, and $\beta_4 = 0.7$. The probability of handover failure against number of channel of micro cell is plotted in Figs. 7 and 8, taking channel count of macro and satellite cell as parameter.

5. Conclusions

It is demonstrated in previous sections that, when increasing the channel capacity of any layer, the cell or channel utilization of that layer increases with decreased or constant utilization of other layers, which validates the composite traffic analysis. Falling slope and decreased height of curves with increase of m and k validates the analysis of the proposed call admission scheme. In this traffic model, the handover voice call gets maximum opportunity of using trunk of overlaid cells to minimize probability of forced termination. Handover part of data call were included in total arrival part of traffic. It would not be a difficult job to implement a different call admission control scheme providing guard channel of macro cell to carry data handover traffic. Here all traffic parameters were evaluated based on one dimensional Markovian chain of Figs. 2 and 4. Still there is a room for improvement of results by considering three dimensional chain of three types of arrival traffic (data, new voice call and handover voice arrival). Inclusion of impatient users and take-back could further improve modeling accuracy.

References

- [1] K. Zhang and K. Pahlavan, "An integrated voice/data system for mobile indoor radio networks", *IEEE Trans. Veh. Technol.*, vol. 39, no. 1, pp. 75–82, 1990.
- [2] K. Pahlavan and P. Krishnamurthy, *Principles of Wireless Networks*. New Delhi: Prentice-Hall, 2003.
- [3] B. Jabbari and W. F. Fuhrmann, "Traffic modeling and analysis of flexible hierarchical cellular networks with speed-sensitive handoff strategy", *IEEE J. Sel. Areas Commun.*, vol. 15, no. 8, pp. 1539–1548, 1997.
- [4] ———, "An analytical model of traffic performance of mobile cellular network in underlay overlay cell system", in *Proc. 6th Int. Conf. Comput. Inform. Technol. ICCIT*, Dhaka, Bangladesh, 2003, vol. 1, pp. 230–234.
- [5] K. L. Yeung and S. Nanda, "Channel management in micro/macro cellular radio systems", *IEEE Trans. Veh. Technol.*, vol. 45, no. 4, pp. 14–23, 1996.
- [6] P. Fitzpatrick, C. S. Lee, and B. Warfield, "Teletraffic performance of mobile radio networks with hierarchical cells and overflow", *IEEE J. Sel. Areas Commun.*, vol. 15, no. 8, pp. 1549–1557, 1997.

- [7] G. D. Morley and W. D. Grover, "Strategies to maximize carried traffic in dual-mode cellular systems", *IEEE Trans. Veh. Technol.*, vol. 49, no. 2, pp. 357–366, 2000.
- [8] J. Mar and J. P. Huang, "Traffic performance analysis of integrated dual-band cellular radio network", *IEE Proc. Commun.*, vol. 147, no. 3, pp. 180–187, 2000.
- [9] ———, "An analytical model of performance evaluation of SDMA based mobile cellular network for limited user traffic case", *Jahangirnagar Univ. J. Sci.*, vol. 27, pp. 134–143, 2004.
- [10] ———, "An analytical model of low dense network traffic for LEO mobile satellite systems", *J. Electron. Comput. Sci.*, vol. 5, pp. 31–44, 2004.
- [11] B. Li, L. Li, B. Li, K. M. Sivalingam, and X.-R. Cao, "Call admission control for voice/data integrated cellular networks: performance analysis and comparative study", *IEEE J. Sel. Areas Commun.*, vol. 22, no. 4, pp. 706–718, 2004.
- [12] M. Mahdavi, R. M. Edwards, and S. R. Cvetkovic, "Policy for enhancement of traffic in TDMA hybrid switched integrated voice/data cellular mobile communications systems", *IEEE Commun. Lett.*, vol. 5, no. 6, pp. 242–244, 2001.
- [13] Q. Hung, S. Chan, K.-T. Ko, and M. Zukerman, "An enhanced hand-off control scheme for multimedia traffic in cellular networks", *IEEE Commun. Lett.*, vol. 8, no. 3, pp. 195–197, 2004.
- [14] T. Veerarajan, *Probability, Statistics and Random Process*. New Delhi: Tata McGraw-Hill, 2003.
- [15] S. M. Ross, *Introduction to Probability Models*. San Diego: Academic Press, 2001.
- [16] R. Ramjee, R. Nagarajan, and D. Towsley, "On optimal call admission control in cellular networks", *Wirel. Netw. J.*, vol. 3, no. 1, pp. 29–41, 1997.
- [17] Y. Fang, "Thinning scheme for call admission control in wireless networks", *IEEE Trans. Comput.*, vol. 52, no. 5, pp. 685–687, 2003.
- [18] ———, "Analysis of two dimensional limited source and mixed traffic model for a BTS of small mobile cellular network", in *Proc. 4th Int. Conf. Comput. Inform. Technol. ICCIT*, Dhaka, Bangladesh, 2001, pp. 190–196.
- [19] G. M. Galvan-Tejada and J. G. Gardiner, "Theoretical model to determine the blocking probability for SDMA systems", *IEEE Trans. Veh. Technol.*, vol. 50, no. 5, pp. 1279–1288, 2001.



Imdadul Islam has completed his B.Sc. engineering in electrical and electronic engineering from Bangladesh University of Engineering and Technology, Dhaka, in 1993 and M.Sc. engineering from the same institute in 1998. Now he is perusing Ph.D. at the department of CSE, J.U., Dhaka, in the field of teletraffic engineering. He worked as an Assistant Engineer in Sheba Telecom (Pvt.) Ltd. (a joint venture company between Bangladesh and Malaysia, for mobile cellular and WLL), from Sept. 1994 to July 1996. He has very good field experiences in installation of radio base station and switching center for WLL. He is now working as an Associate Professor, at the Department of Computer Science and Engineering, Jahangirnagar University, Savar, Dhaka, Bangladesh. His research field is network traffic, OFDMA, WCDMA and array antenna

system. He has more than fifty papers in national and international journal and conference proceedings.
e-mail: imdad22000@yahoo.com
Department of Computer Science and Engineering
Jahangirnagar University
Savar, Dhaka, Bangladesh

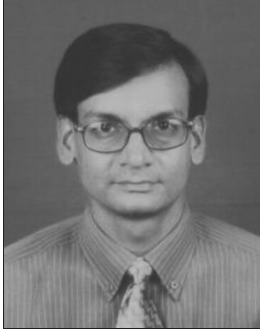

Jugal Krishna Das was born in Shariatpur in 1964. He received his M.Sc. and Ph.D. in computer engineering from Donetsk Technical University of Ukraine in 1989 and 1993, respectively. He joined as a lecturer at the Department of Electronics and Computer Science, Jahangirnagar University in 1994 and now serving as a Professor at the

Department of Computer Science and Engineering of the same university. His research interests are in mobile ad hoc network and distributed system.
e-mail: drdas64@yahoo.com
Department of Computer Science and Engineering
Jahangirnagar University
Savar, Dhaka, Bangladesh

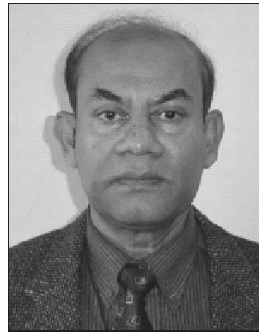

Siddique Hossain is the senior most Professor of Department of Electrical and Electronic Engineering, Bangladesh University of Engineering and Technology, Dhaka. He has more than 34 years of teaching, research and administrative experience both at home and abroad. Worked as the Head, EEE Department, Head, CSE Department,

Dean, EEE Faculty and Director, BUET Computer Centre. He worked as a visiting faculty member of more than ten universities. He is a Senior Member of IEEE and was engaged as Chief of IEEE in Bangladesh in 1997–1998. He is interested in the field of computers and communication engineering, 3G mobile communication, wideband code division multiple access (WCDMA) for universal mobile telecommunication system (UMTS), etc. He has more than 40 publications in national, international journals and conference proceedings.

e-mail: sdq@eee.buet.ac.bd
Department of Electrical and Electronic Engineering
Bangladesh University of Engineering and Technology
Dhaka, Bangladesh