

MEASUREMENTS OF SMA PROPERTIES USING ADVANCED OPTICAL METHODS

SUMMARY

Shape Memory Alloys are called smart or advanced materials because of their special features which are very useful in the latest solutions. Therefore, it is very important to gain a good knowledge of all these features for the purposes of modeling, describing, and ultimately controlling the behavior of these materials. This paper describes how to measure selected properties of SMA. It describes how to measure real temperature and diameter of thin SMA wires. At the end, we use a high speed camera to find out how an SMA wire breaks during stretching.

Keywords: smart materials, measurements, optical methods

ZASTOSOWANIE ZAAWANSOWANYCH METOD OPTYCZNYCH W POMIARACH WŁASNOŚCI STOPÓW Z PAMIĘCIĄ KSZTAŁTU

Stopy z pamięcią kształtu (Shape Memory Alloys – SMA) nazywane są zaawansowanymi materiałami ze względu na ich specjalne własności, które są chętnie stosowane w nowoczesnych rozwiązaniach technicznych. Identyfikacja ich w celu lepszego poznania, modelowania a w także sterowania ich parametrami jest niezbędna we właściwym stosowaniu tych materiałów. W artykule opisano, jak zmierzyć rzeczywistą temperaturę i średnicę cienkiego drutu SMA z wykorzystaniem kamery termowizyjnej i mikrometru laserowego. Opisano również badania z użyciem kamery HSC zjawisk zachodzących w trakcie zerwania drutu SMA.

Słowa kluczowe: stopy z pamięcią kształtu, pomiary, metody optyczne

1. INTRODUCTION

Shape Memory Alloys (SMA) are metals which are capable of storing their remembered shape in memory and regaining it when subjected to external conditions, such as magnetic field or temperature changes. Well-known shape memory alloys include: Ni-Ti, Cu-Zn, Au-Cd, Ag-Cd, and Cu-Al. The specific properties of these alloys are related to the inverse martensite transition. The best known shape memory alloy is that of titanium and nickel (mass concentration of nickel 53–57%). The phase transition, which affects the shape memory in NiTi alloy, involves transition from martensite to austenite. Two processes occurring in SMA materials are distinguished: shape memory as one- and two-way shape memory effect and super-elastic behavior or pseudo-elastic behavior (Bojarski and Morawiec 1989; Wayman and Otsuka 2002).

Shape memory alloys are very often used as actuators. In other words, they work like a solenoid or motor for many cycles. The high repeatability of such applications requires a dependable, reliable and very repeatable material. We can describe these applications as two state or discrete but the most interesting applications of SMA wires are actuators with analogue output, such as hydraulic or electric linear actuators. However, such actuators have disadvantages, e.g. strong nonlinearity and hysteresis. These are the main problems in designing a linear actuator. This paper shows selected results of some conducted tests. Tests were conducted in

order to discover the real precise characteristics or features of SMA wires.

The tested SMA wires are made of NiTi alloy whose transformation temperatures are: $M_f = 57\text{ }^\circ\text{C}$, $M_s = 67\text{ }^\circ\text{C}$, $A_s = 72\text{ }^\circ\text{C}$, $A_f = 90\text{ }^\circ\text{C}$. All tests were conducted on a test stand shown on Figure 1.

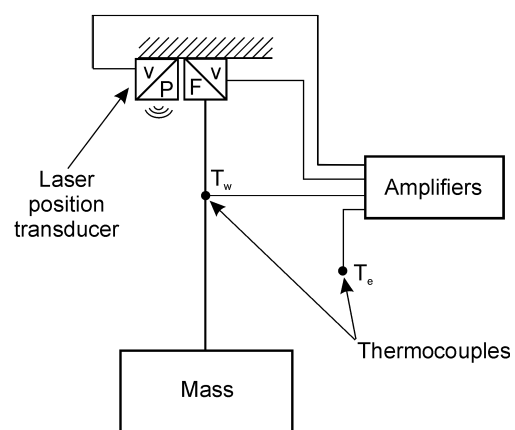

Fig. 1. Block scheme of test stand

2. MEASUREMENT OF SMA WIRE TEMPERATURE

In many applications of control systems for SMA thermocouples or PT100 are used for measuring the temperature of controlled wires. It is a good solution when we measure

* Department of Process Control, Faculty of Mechanical Engineering and Robotics, AGH University of Science and Technology, Krakow, Poland; waldemar.raczka@agh.edu.pl; andrzej.sioma@agh.edu.pl

temperature of thick wires, but we assumed that in the case of small-diameter wires the sensor measures wrong temperature. For testing the hypothesis, we employed a thermographic camera.

Thermographic cameras detect radiation in the infrared range of the electromagnetic spectrum and produce images of that radiation. Infrared radiation is emitted by all objects which have temperature above 0 K. The amount of radiation emitted by an object increases with temperature, therefore thermography allows to see temperature variations. Based on analysis of thermal images, accurate temperature measurements can be made to detect even the smallest temperature differences.

In tests, ThermaCAM SC640 was used. This camera can prepare very high resolution, 640×480 pixel, images. It

allows taking thermal images of the smallest objects in a non-contact mode. In the course of investigation, it was necessary to measure the diameters of wires in the range from 0.3 to 0.6 mm. The tests measured temperature of SMA wire (Fig. 2) by thermocouple and by thermographic camera. Results are shown on Figures 3 and 4. On upper parts of figures, we can see current excitation, and on lower, courses of SMA wire temperatures obtained with thermocouple (blue line) and thermographic camera (red line) are shown. We can see that the course obtained with thermocouple is delayed in relation to current excitation and this curve is very smooth. The course obtained with a camera is sharper. When analyzing it, we can observe phase transitions – phase transition from martensite to austenite can be found on Figure 3 about 15 seconds, 65 seconds, and



Fig. 2. Thermographic view of tested wire

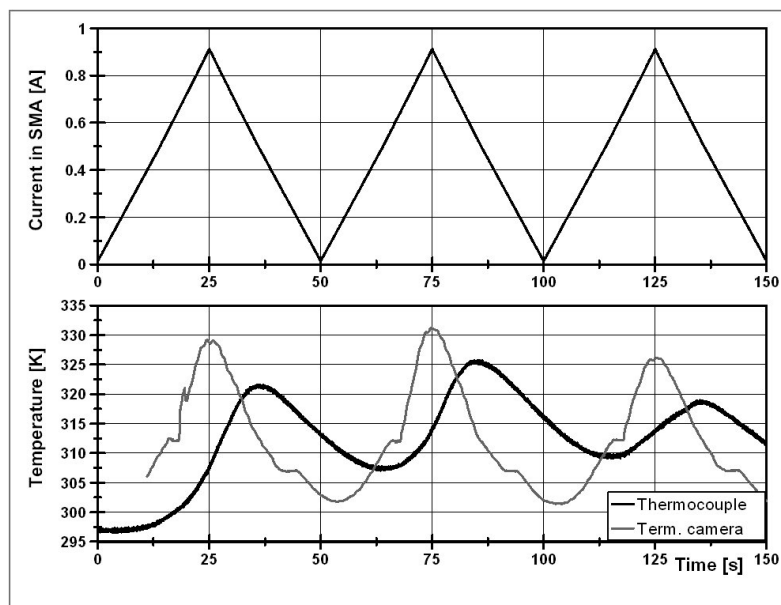

Fig. 3. Courses of current excitation and temperature

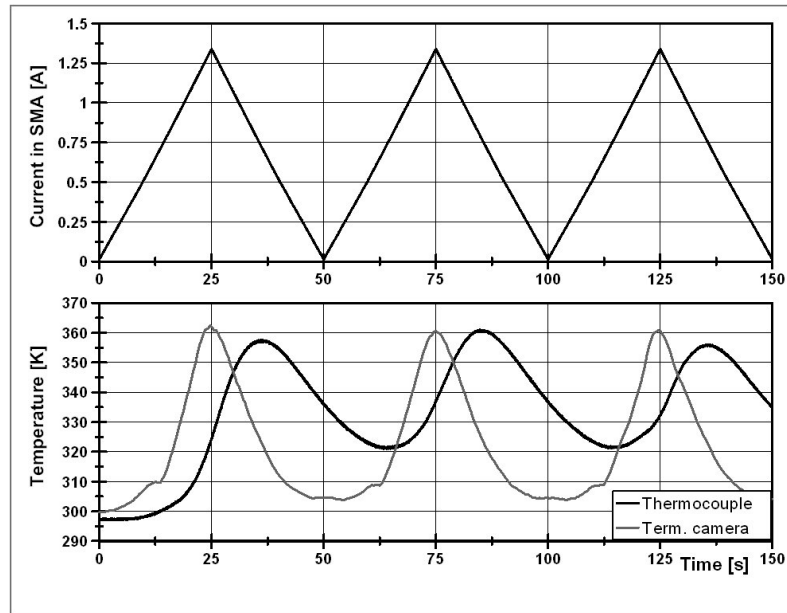

Fig. 4. Courses of current excitation and temperature

115 seconds in, and phase transition from austenite to martensite about 47 seconds, 97 seconds, and 147 seconds in. On Figure 4, we can observe phase transition from martensite to austenite 13 seconds, 63 seconds, and 113 seconds in, but we cannot observe reverse phase transitions. It is impossible to notice transitions in the case of measuring temperature by thermocouple. We can say, that in case of thin wires, measuring temperature with a thermocouple produces big errors (even 30 K). In precise control systems, thermocouple as feedback is the wrong solution.

3. MEASUREMENT OF SMA WIRE DIAMETER

Measurement of SMA wire diameter was carried out during investigations, including heating and cooling working cycle. The shortening parameters of SMA wire length are well-known during the cycle, but changes in SMA diameter as well as relations between those parameters are interesting.

In the experiment, the LS7010 CCD optical micrometer was used. This micrometer works with measurement accuracy of $\pm 0.5 \mu\text{m}$ and repeatability of $\pm 0.06 \mu\text{m}$ with speed up to 2400 samples per second. The LS-7010 is designed for precision measurement applications, such as the diameter measurement example: ultra-fine optical fibers. The measuring range is from 0.04 mm to 6 mm. In Digital Micrometer LS-7010, high-intensity GaN (Gallium Nitride) 520 nm green LED light source is used. The short wavelength offers higher resolution than conventional laser scan systems and more closely matches the operating characteristics of the CCD receiver element than GaP laser diodes. Its parallel light goes through the special diffusion unit and collimator lens and emitted to the SMA wire. Then the

shadow image of the SMA wire will appear on the high-speed linear CCD cross over the telecentric optical lens. This telecentric optical system that uses only parallel light to form an image thus preventing fluctuations in lens magnification due to changes in target position.

The output incident signal of the linear CCD will be processed by the DE (digital edge-detection) processor in the controller and CPU. As a result, the dimensions of the SMA wire will be displayed on monitor and outputted by analog output. Voltage on this analog output is proportional to the diameter or diameter changes. The continuous exposure measurement using high-speed linear CCD enables high-speed sampling which doubles speed and accuracy in reference to laser scanning method. With no moving parts, the LS-7010 measuring head generates no heat or vibration during measurement process. The CMOS monitor sensor built into the measuring head captures the image of SMA wire, which is displayed on the LCD monitor. Since the measurement condition is visible, SMA positioning and measurement condition can be controlled. The measurement area of the current measurement mode is indicated in real time.

The test stand is shown on Figures 5 and 6. They are micrometer and its screen with sample course of diameter changes.

On Figure 7, we can see courses as described above. Maximal changes in SMA wire diameter are up to 1.5% and maximal relative shortening is 4.2%. It is clear that changes in the diameter and length are related to current excitation, which heats the wire. There is a good repetition of changes when we have high excitation currents, but with smaller values repetition is very poor. We can observe phase transitions on course of relative diameter changes (Fig. 8).

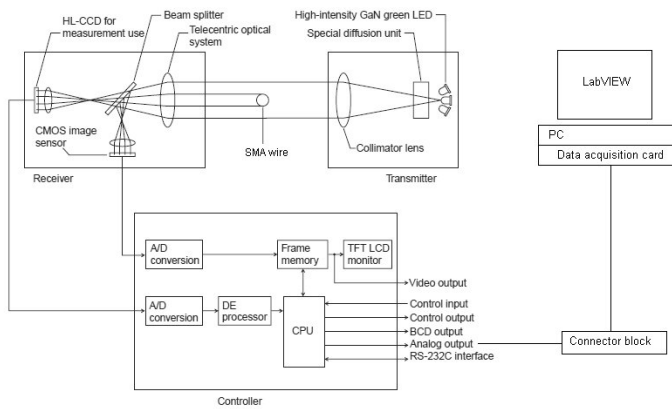

Fig. 5. Configuration of test stand

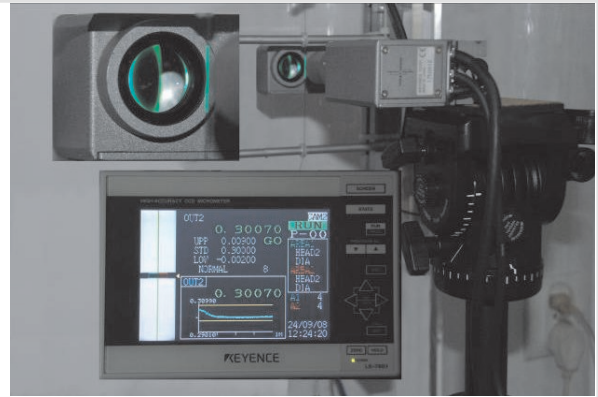

Fig. 6. View of test stand with LS-7010M micrometer

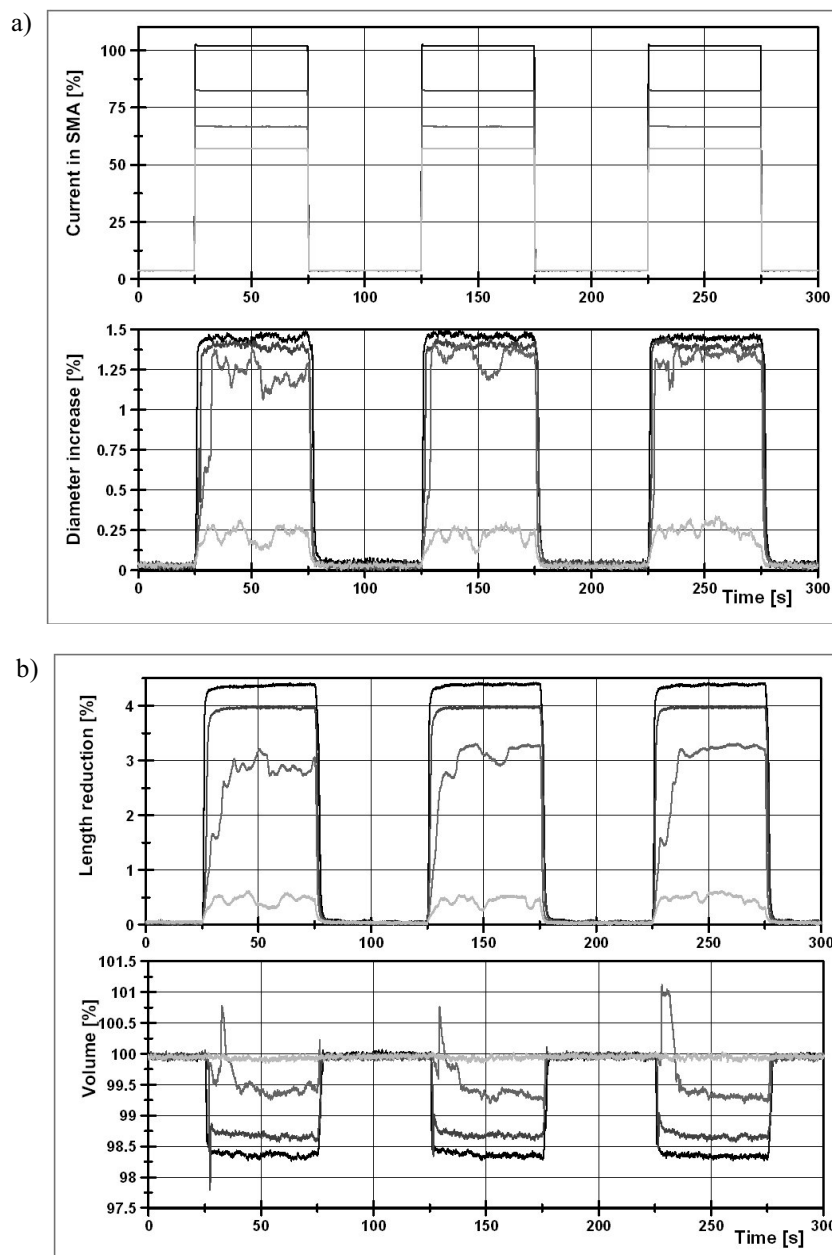

Fig. 7. Course of current excitation (upper), course of wire relative diameter changes and relative shortening of the wire (lower), square current excitation (a); course of SMA wire length reduction (upper), course of wire volume reduction (lower) with square current excitation (b)

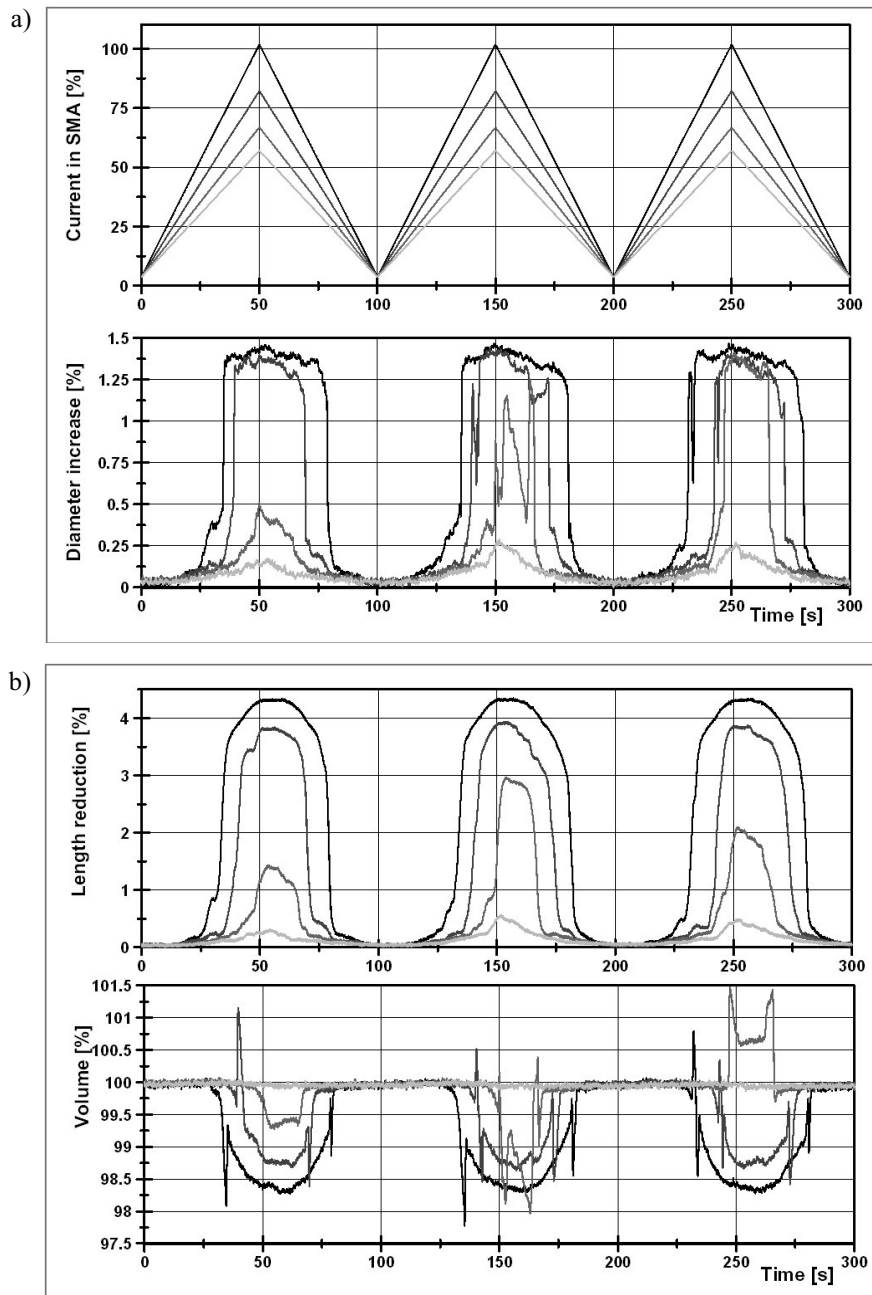

Fig. 8. Course of changes in wire diameter in the case of triangular excitation (a, b)

Figure 8a shows courses of changes in the diameter of the tested wire. Those changes are shown in dimensionless units in relation to the initial wire diameter. Those courses reveal significant reduction in wire diameter in high temperatures. That indicates change in SMA density. In the martensitic state (low temperature), SMA density is lower than in the austenitic state (high temperature). Figures 8a and 8b show also sudden (spike) changes in the diameter during phase transitions (at around 30 seconds in on Fig. 8a). Such rapid changes may be caused by phase transitions, but also by time displacements in the measurement signal from the displacement transducer in relation to the signal from the optical micrometer. At that stage of research, it is impossible to determine whether it is a physical

phenomenon or a dynamic measurement error due to the fact that the delay times of the output signal in relation to the input signal for both transducers are unknown.

4. OBSERVATIONS OF SMA WITH HIGH SPEED CAMERA

In SMA tensile test, i-SPEED 3 camera was used (Fig. 9). The camera is the latest addition to the Olympus i-SPEED range. The camera has been designed to an advanced specification providing high resolution analysis for high level research. This instrument has been designed to capture video with extreme low light sensitivity and high speed events up to 150.000 fps (frames per second).



Fig. 9. General view of i-SPEED 3 camera

The captured video is stored in internal memory and subsequently replay the video at slower speeds. The I-SPEED 3 can work on low light because of using new generations of CMOS sensor with 21 micron pixels size. The camera makes

it possible to capture frames of video with limit of frame speed of 2.000 fps for a full resolution (1280×1024) image. If faster operation is required, the number of pixels per frame must be reduced, and this is accomplished by reducing the active area of the sensor. When the camera works in the record mode, frames are stored continuously in the internal memory. That memory is configured in a circle, owing to which, when the memory is full, each new frame replaces the oldest one. This way, the camera keeps a rolling history of the scene it views and this process can continue indefinitely.

The camera described above was used in the last experiment. In the tensile test, the SMA 5 mm diameter wire was tested. The test was videoed by camera with the speed of 500 fps, 2000 fps and 10000 fps. Selected captured photos were “glued” and are shown below (Figs. 10–12). As we see, some interesting things were happening when the wire broke. We can observe explosion of small alloy particles (Figs. 10 and 12). On Figure 11 and 12, we can observe a very interesting phenomenon – a flash of light.



Fig. 10. Pictures captured and recorded with 500 fps speed

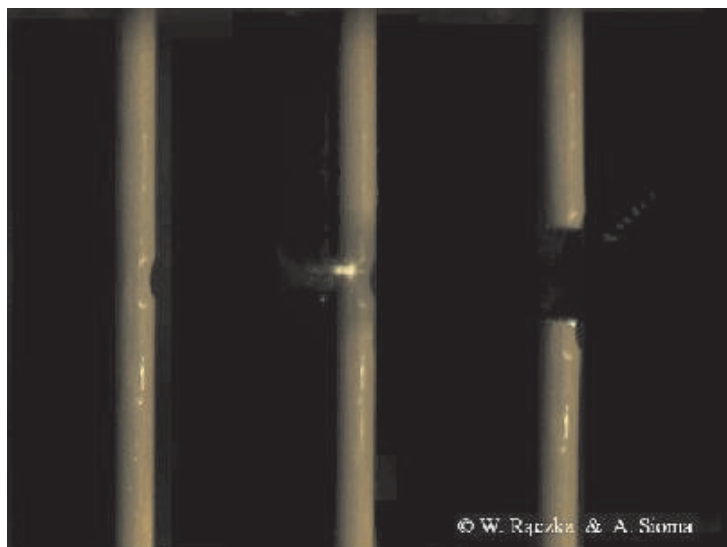

Fig. 11. Pictures captured and recorded with 2000 fps speed

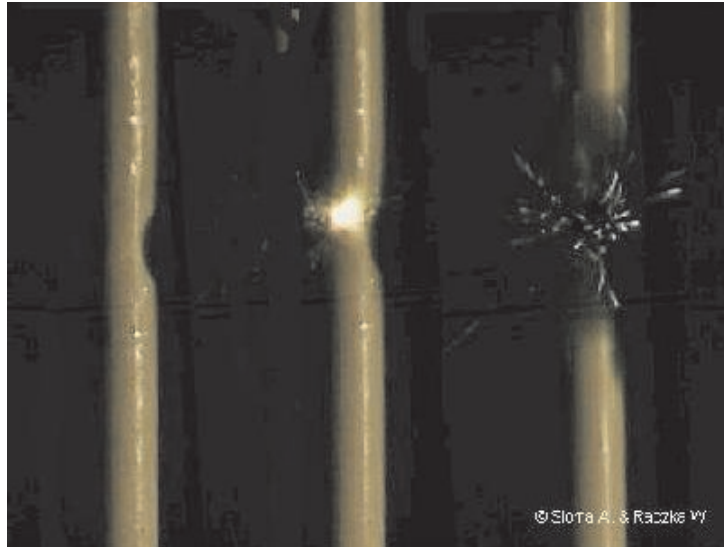

Fig. 12. Pictures captured and recorded with 10000 fps speed

5. CONCLUSION

The article describes innovative research methods used in smart materials research. The results obtained have shown significant superiority of those methods over classic measurement methods. In many cases, classic methods prove insufficient. When temperature measurement using the classic thermocouple is compared with that using thermographic camera, it is clear that the time constant of the thermocouple is so high that it is impossible to observe phase transitions. Thermographic camera, on the other hand, records such transitions, which allows analysis thereof. However, also in that case (see Fig. 4) it turns out that transitions are not always recorded. Most probably, it is caused by insufficient number of frames per second recorded by the camera, and incorrectly selected point for determining temperature course. The advantages of thermographic camera include, but are not limited to, the possibility of observing and recording the distribution of temperatures on the surface of the tested object, the possibility of determining temperature course at any point of the tested object, small time constant, and minimum interference with the tested object. The main disadvantage of the thermographic camera is primarily its price. Other disadvantages include the camera's dimensions and the need to use a PC. Dimensions and price prevent miniaturization and use of the thermographic camera in common automatic devices, however in the case of special tasks, those disadvantages are often no longer of importance.

Measurements of changes in wire diameter were conducted using optical measurement methods: laser position transducer to measure wire shortening and optical micrometer to measure the diameter. Optical measurement devices do not exert any load on the wire, owing to which phase transitions occur without disturbance. Classic measurement devices, such as micrometer screw gauge, microscope, or induction displacement sensors, introduce addi-

tional load forces or do not allow the recording of courses of changes in dimensions.

The last measurement device used – high speed camera, allows the recording and subsequent analysis of very fast events. In this article, high speed camera was used to record the events which occur when NiTi wire is broken. Analysis of the successive photographs (Figs. 10–12) reveals three phenomena: implosion of metal particles (Fig. 10), flash of light (Figs. 11,12), and explosion of small alloy particles (Fig. 12). The phenomena of implosion and explosion are observed in successive photographs and are most probably triggered by the same cause. Most likely, when the wire is broken, small metal particles move together with the air into the space where the wire was a moment ago. That process progressed until they collide, and then the elastic medium, i.e. the air, expands and those metal particles are shot back where they had come from or, which is more probable, move in the same direction, but outwards (a particle moving from left to right into the wire continues its movement in the same direction but after it crosses the wire symmetry axis, it starts moving outwards). A similar phenomenon of implosion and explosion occurs when a kinescope is broken. The most interesting phenomenon is a flash of light observed in photographs (middle of Figs. 11 and 12). That phenomenon may have a number of causes. The emitted light may be the effect of explosive oxidation of nanoparticles; another explanation is an analogous phenomenon known as shrim-poluminescence (Lohse *et al.* 2001). Snapping shrimp produces a loud crackling noise. This make cavitation bubble in water, when this bubble collapses, intense flash of light is emitted. Collapse of the bubble indicates extreme pressures and temperatures of at least 5.000 K. In our case, there is no water, but the observed phenomenon may have similar causes. Yet another explanation for the observed emission of light may be release of energy accumulated in the crystalline structure of the metal. Obviously, they are all

hypotheses which need to be verified in further research on that phenomenon.

Acknowledgement

This work has been done as a part of research and development projects N0300403 and N N502 266137, supported by the Polish Government 2007–2010.

References

- Bojarski Z., Morawiec H. 1989, *Metale z pamięcią kształtu*. Warszawa, PWN.
- Lohse D., Schmitz B., Versluis M. 2001, *Snapping shrimp make flashing bubbles*. *Nature*, 413, pp. 477–478.
- Wayman C.M., Otsuka K. 2002, *Shape Memory Materials*. Cambridge University Press, UK.