

Piotr Skubisz^{***}, Jan Sińczak^{*}, Sylwia Bednarek^{***}, Aneta Łukaszek-Sołek^{**}

EFFECT OF DEFORMATION DEGREE ON PROPERTIES OF FORGINGS AFTER THERMOMECHANICAL TREATMENT

1. INTRODUCTION

Combination of plastic deformation and heat treatment, referred as controlled processing or thermomechanical treatment, is an effective way to improve mechanical properties of steel [1]. As such, it forms the basis for technologies which provide obtaining microstructure favourable for optimal combination of high strength and ductility, better impact toughness, improved corrosion and fatigue resistance. Altogether it allows manufacturing parts and structural components of superior technological characteristics, higher quality of products and better performance [2, 3]. Although benefits of thermomechanical processing over conventional forming with subsequent heat treatment are commonly known, and controlled processing with accelerated cooling is to an ever-increasing extent well established technological process nowadays, constant development of materials science and emerging new grades of steels, with microalloyed steels at the forefront, gives a rise to further researches in the range of determination of thermomechanical treatment conditions to achieve further improvement of mechanical properties and minimization of manufacturing costs. This scientific activity has been followed by development of new processing technologies, based on controlled deformation conditions, required austenite grain structure and cooling conditions, which allow proper run of transformation kinetics.

Large number of currently conducted studies concern utilization of microalloyed steels [4, 5], which make it possible to obtain high strength with carbon reduced to the content of low or medium-carbon steels. Solution hardening is then attained by additions of silicon and manganese. Micro additions of vanadium, titanium, niobium and aluminium provide fine-grained austenite structure by hampering its growth owing to non-dissolved precipitates (which further bring precipitation hardening), which ensures obtaining fine-grained ferrite-pearlite, bainite or martensite and retained austenite structure after cooling to room temperature [6–9].

* Ph.D., D.Sc., ** Ph.D.,*** M.Sc.: Faculty of Metals Engineering and Industrial Computer Science, AGH University of Science and Technology, Krakow, Poland; sinczak@metal.agh.edu.pl

These days benefits growing out of thermomechanical treatment only scarcely are used in forging technologies. One of the causes is diversity of sizes and configurations of forged parts, which calls for the necessity of determination of temperature regime and cooling pattern for each case individually, not ensuring versatility of assumed parameters even when the same shape coefficient. The nature of the forging processes itself produces differences in amount of deformation in adjoining sections, as well as, differences in temperature gradients arisen by local differences in generated deformation heat and local variations in time of contact of billet and tools. In addition, nonuniformity of grain size resultant from dynamic recrystallization and variable heat transfer conditions, associated with differences in structural heterogeneity in combination with geometrically conditioned cooling rate differences in neighbouring regions of a part, form diverse conditions for structural transformations kinetics. While designing forging technology involving simultaneous heat treatment, in addition to phenomena that affect microstructure development, a number of technological setbacks needs to be coped with.

Nevertheless, for the necessity of searching for savings in a manufacturing cycle, thermomechanical treatment focuses ever-increasing attention among forging shops, similarly, replacement of traditional heat treatment methods is more and more popular subject in scientific literature [5, 10–12].

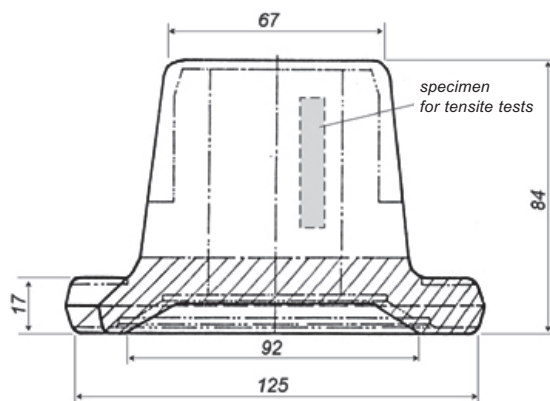

Fig. 1. Geometry and major dimensions of the forging of a flange

Taking into consideration the abovementioned reasons, this work presents analysis of possibility of utilization of thermomechanical treatment in the manufacturing process of a forged part of significant complexity, characterized by large diameter in relation to the thickness of a flange and significant height of the central boss (Fig. 1) Large cross sectional area in a parting plane is the reason why the part is forged on mechanical presses or forging hammers, which produces insignificant temperature gradient in the volume during the whole forging cycle.

Short times of metal/tools contact allow for utilization of deformation heat for quenching directly after forging, which, if only proper temperatures and controlled cooling rate are attained, should provide satisfactory properties of a finished part.

2. EXPERIMENTAL PROCEDURES

In order to obtain information on the influence of deformation degree on mechanical properties of the forged part, three slenderness values were used with keeping constant volume (Fig. 2). Degree of deformation was defined by relative height reduction in the first stage of the forging process of the central boss. In this stage, irrespective of the slenderness

of a billet, upsetting alike pattern of strain prevails. Billet diameter was conditioned by upper-impression cavity diameter with three values assumed for test: 75 mm, 70 mm and 65 mm. For these diameters of a billet, the height reduction values in the first stage of forging are, respectively, a – 20%, b – 30%, c – 40% (Fig. 2). The analysed forging was made of medium-carbon steel of following chemical composition: C – 0.3%, Mn – 0.94%, Si – 1.05%, Cr – 0.9%, Ni – 0.05%, Ti – 0.05%, P – 0.022%, S – 0.018%.

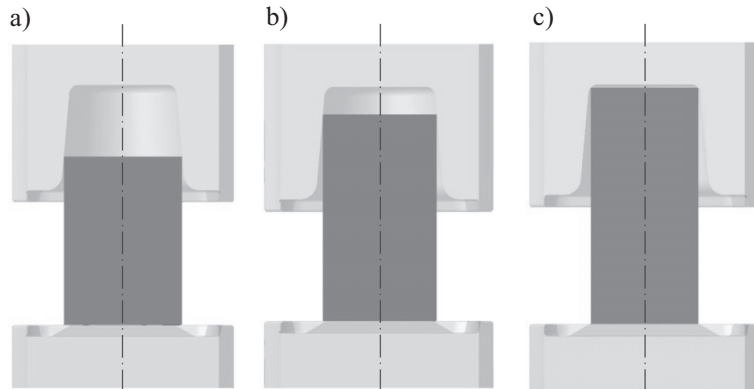

Fig. 2. Initial dimensions of billet resulting in height reduction: a) 20%; b) 30%; c) 40%

Austenitization temperature was 950°C, and the processing was conducted in accordance with a scheme presented in Figure 3a. For steel of a given chemistry transition points are A_{C1} 750°C, A_{C3} 840°C, M_s 340°C. After heating to 950°C and homogenization at this temperature, temperature was decreased to deformation temperature of 890°C. After deformation followed by 3 seconds stand, the forging was cooled with a cooling rate high enough to omit bainitic transformation. Temperatures and cooling rate was determined on the strength of continuous cooling diagram derived from literature [13] and estimated with TTSteel software [14] (Fig. 3b).

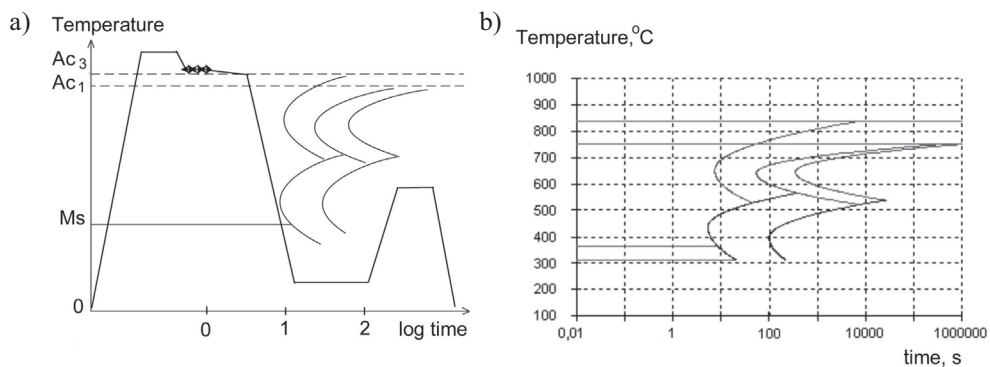

Fig. 3. Diagrams of: a) thermomechanical treatment conditions; b) continuous cooling calculated with TTSteel

In order of obtaining information on energy parameters of forging (forging load, mean stress distribution) and strain distribution (effective strain) forging tests were complemented with numerical analysis with a use of a commercial code for bulk metal forming processes QForm3D, based on finite element method. Calculations in three-dimensional state of deformation were carried out, with assumption of elastic-viscoplastic model of deformed body. Details on the code can be found in [15]. Boundary conditions were assumed in accordance with process parameters in experiment: friction factor 0.4, active heat transfer coefficient 3500 W/(m·K) (graphite-water lubrication), tool temperature 300°C, constant thermal conductivity of the metal 80 W/K/m², forming speed 0,5 m/s.

From the obtained forgings specimens for tensile testing and metallographic work were taken out. The obtained microstructures formed an illustration of the initial material condition and after conventional forging with subsequent quenching-tempering compared to applied processing conditions. The location of specimens for tensile testing is shown in Figure 1.

3. RESULTS

3.1. Numerical Modelling

Estimated numerically distribution of effective strain in the last stage of forging with average reduction in height equal to 20%, 30% and 40% is presented in Figure 4. In all the cases similar distribution of effective strain isolines in the region of the disc of the flange was observed. Gradient of deformation along the central line, referred as relation of the highest value to the least value of effective strain, in the volume of the forging is significantly high and as it equals to approximately 15, exceeds one order of magnitude (ranging from 0.1 in the boss to 1.5 in a flange disc).

A consequence of such distribution of strain is nonuniform distribution of mechanical properties in a finished part. In the region of the body the gradient of effective strain is smaller and it ranges from 5 for 20% reduction (Fig. 4a) to 2 for 40% reduction (Fig. 4c). It should be noted that effective strain values in the half of the total final height of the part obtained at 40% reduction is twice as high as that for 20% reduction.

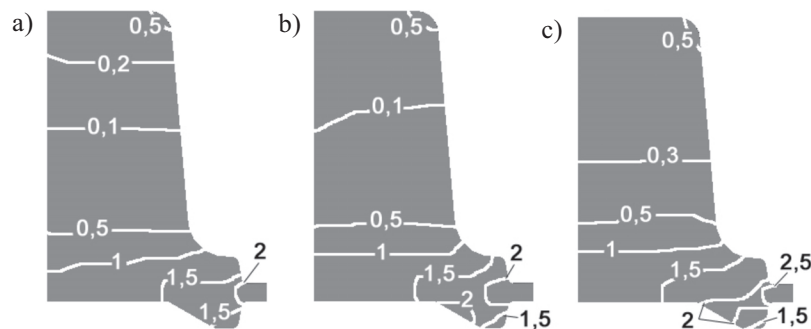

Fig. 4. Numerically calculated effective strain distribution in the end stage of forging process for average height reduction: a) 20%; b) 30%; c) 40%

Forging process with thermomechanical treatment is held in significantly lower temperatures than traditional forging process. As a consequence, value of the forging load and loading of the tools are bigger. To estimate changes in load during the whole forging cycle, numerical calculations were carried out. The results are presented in Figure 5. It was concluded that character of the curves is similar for all analysed forging stock slenderness values. The ending stage of the process, which is connected with forcing the metal to the flash (at reduction 80%) brings threefold increase in load. Characteristic feature of case of the highest slenderness is violent increase in forging load in the beginning stage of the process (curve c, detail A, in Fig. 5). In this case, stage of tapering does not occur in the process.

Another important parameter, which influences the tool life is the level of mean stress observed in the last stage of the cycle. Numerically calculated distribution of mean stresses is shown in Figure 6. Maximum mean stress value reported in all cases reaches 1000 MPa. Insignificantly is the value exceeded in the forging the lowest slenderness (Fig. 6a). Most favourable profile of mean stress is observed for the billet of the highest slenderness, hence, highest tool life can be expected.

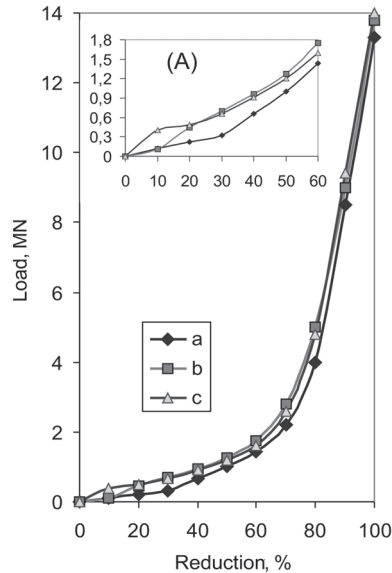

Fig. 5. Numerically calculated forging load for average height reduction: a) 20%; b) 30%; c) 40%; where detail A is an enlargement of the plots in the range to 60% deformation

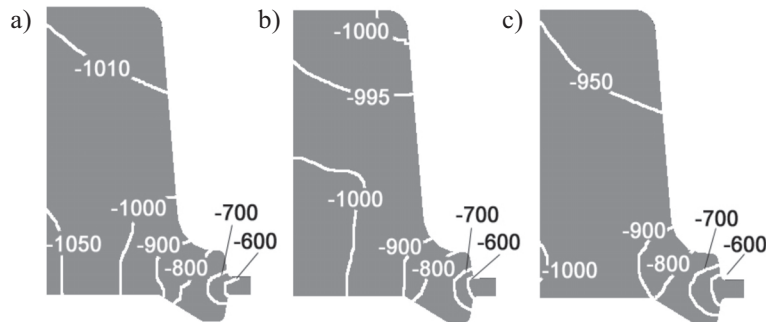

Fig. 6. Numerically calculated mean stress distribution in the end stage of forging process for average height reduction: a) 20%; b) 30%; c) 40%

3.2. Metallographic Work

Specimens cut out from the central zone of the forging were polished and nital etched to reveal grain structure and structural components. In Figure 7 micrographs of the material in as-forged condition, in traditionally quenching-tempering and thermomechanical treatment are shown.

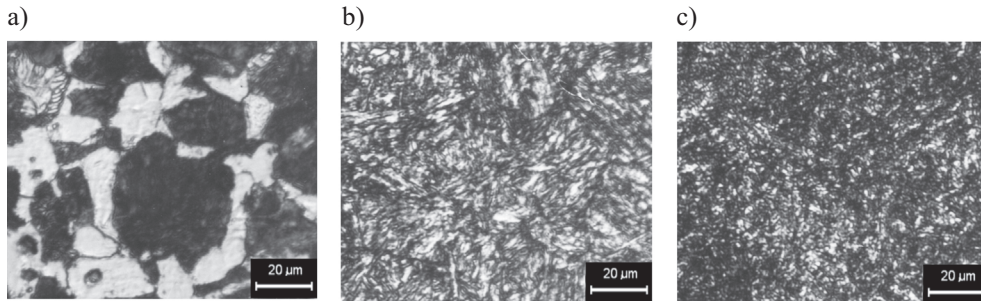

Fig. 7. Microstructure of the forged flange in condition: a) as-forged; b) quenched-tempered; c) thermomechanically treated

Both in result of conventional and thermomechanical treatment tempered martensite with rest austenite was obtained, however, in case of the latter process, significant grain refinement was achieved. Estimated grain size before forging was 5–5.5 ASTM (Fig. 7a). After forging and conventional quenching and tempering treatment it was estimated to be 7–7.5 ASTM (Fig. 7b), whereas, after thermomechanical processing it was refined to 8–9 ASTM (Fig. 7c).

3.3. Tensile Properties

Tensile testing was performed with a use of testing machine Instron 1196. Ultimate tensile strength, tensile yield stress, elongation to fracture and area reduction at fracture obtained in testing are show in Figures 8 and 9.

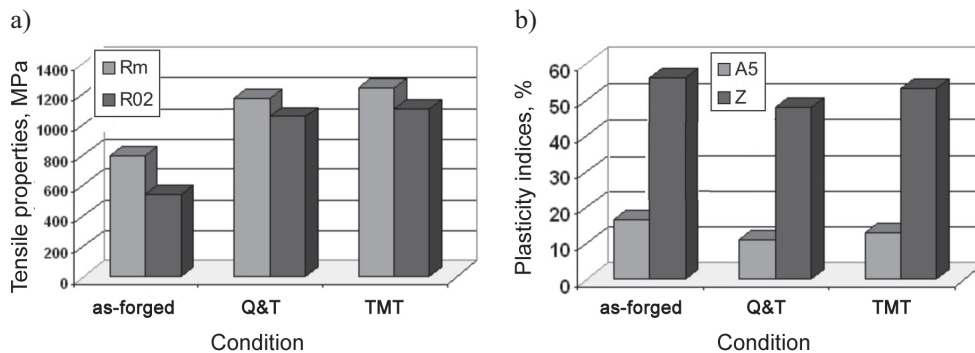

Fig. 8. Comparison of: a) tensile strength and yield stress; b) elongation and area reduction at fracture of the material in as-forged condition (without heat treatment), after quenching-tempering (Q&T) and after thermomechanical treatment (TMT)

Presented in Figure 8 diagrams of ultimate tensile strength and yield stress of the steel after thermomechanical processing for 30% reduction are, 1241 and 1103 MPa, whereas, after conventional heat treatment, respectively, 1169 and 1049 MPa.

In turn, elongation and area reduction at fracture – 12,9 and 53.2% for the first technology, and 11 and 48% for the latter.

The effect of reduction on mechanical properties of the forging of a flange after thermomechanical treatment, depicted in Figure 9, indicates strong influence of deformation degree on ultimate tensile strength and yield stress. In the investigated range of amount of deformation the increase in tensile strength is about 10% and so it has a strong effect even at insignificant increasing deformation, measured with reduction in height (Fig. 9a). Simultaneously, plasticity indices (elongation A5 and area reduction Z) remained practically at the same level for all cases of reduction degree (Fig. 9b).

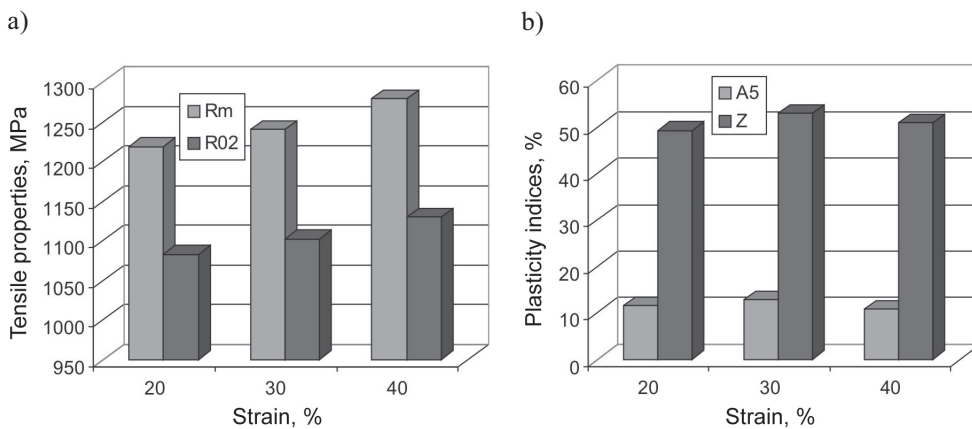

Fig. 9. Effect of degree of deformation on tensile properties (a) and plasticity indices (b) of the forged flange after thermomechanical treatment

4. DISCUSSION

The results of tests of forging with utilization of thermomechanical treatment show a few advantages of this technology in relation to conventional process of drop forging. The presented tests were carried out on a mechanical press which ensures consistent process conditions, and eventually, consistency of whole runs of forged parts. This also ensures possibility of control of the process parameters, which can be held in narrow range, which is a condition of successful realisation of thermomechanical treatment.

In forging on a fast action forging equipment a large amount of deformation heat is generated, which in connection with a short time of a contact metal/tools provides high temperature in the end of the process. Transition points for a given steel, as well as, cooling curves resultant from geometry, call for determined temperature in the whole volume. In the surface, the temperature may not be lower than 800 °C, which is the bottom boundary to impose assumed scheme of cooling.

Directly after forging cooling with speed higher than critical was carried out, to obtain martensitic structure. Owing to strict control of the heating temperature, which prevented from excessive austenite grain growth, and forging temperature, which was held on the level of 50°C over A₃ point, fine-grained martensite was obtained. In addition to fine grains, also needles of martensite were thinner, which resulted in higher strength properties. As shown in Figure 8, an increase in ultimate tensile strength of 70 MPa and yield stress of 50 MPa, as compared to that of conventional process, was noted. Increase in elongation to fracture of 2% and area reduction at fracture of 5% proves ductility enhancement. It should be noted, that the specimens were taken from the core zone of the forging, where the highest temperature, and the lowest amount of deformation was observed, which suggest higher properties in other, more responsible areas. What is more, for the research, a traditional grade of steel was used, not designed for thermomechanical treatment. However, from obtained results of the study it can be concluded that effects of thermomechanical treatment are evident. As such they may form a basis for further research on forging HSLA steels.

5. CONCLUSIONS

The results of the research show that the application of thermomechanical treatment in a forging process, which involved controlled deformation and utilization of the forging heat to perform controlled cooling directly after forging brought significant improvement of strength. Compared to conventional quenching-tempering heat treatment it offers costs savings associated with reduced energy consumption for reheating forged parts, and further savings resulting from the possibility of application lower carbon and low-alloy steels to obtain required properties.

The mechanical properties, reported as the results of tensile tests, show that both improvement in strength and ductility of the material was observed. Ultimate tensile strength is 70 MPa and yield stress 50 MPa higher than that of conventional process, with elongation to fracture by 2% and area reduction at fracture by 5% higher.

Forging on fast action mechanical presses provide convenient conditions to perform controlled forging, as it allows strict control of forging times and temperatures, in comparison with forging on hammers. However, short time of the forging cycle and high strain rate allow keep high temperature of the end of the forging. This requires precise determination of starting temperature and proper cooling conditions. The heat may be used to carry out direct controlled cooling, which with application of microalloyed steels may be utilized for precipitation hardening.

Satisfactory results obtained for medium-carbon structural steel suggest more detailed investigation, especially as for the determination times and temperature of forging and cooling pattern after forging, as well as, deformation in two-phase region and/or ductility improvement with other transformation during cooling. The evident increase in mechanical properties, suggest research on the use of HSLA steels for the manufacture of forgings.

REFERENCES

- [1] *Marcisz J., Garbarz B.*: Hutnik – Wiadomości Hutnicze, 73 (2006) 3, pp. 86–91
- [2] *Bator A., Majta J.*: Hutnik – Wiadomości Hutnicze, 70 (2003) 10, pp. 402–408
- [3] *Barros Cota A. et al.*: Material Research, 6 (2003) 2, 117–121
- [4] *Adamczyk J., Opiela M.*: Hutnik – Wiadomości Hutnicze, 72 (2005) 3, pp. 162–170
- [5] *Adamczyk J.*: Hutnik – Wiadomości Hutnicze, 66 (1999) 11, pp. 529–538
- [6] *García-Mateo C., Lopez B., Rodríguez-Ibabe J.-M.*: Scriptamater, 42 (2000), pp. 137–143
- [7] *Leda H.*: Journ. of Mat. Proc. Techn., 64 (1997), pp. 247–254
- [8] *Karabulut H., Gunduz S.*: Materials and Design, 25 (2004), pp. 521–527
- [9] *Dąbrowski R., Pacyna J.*: Hutnik – Wiadomości Hutnicze, 72 (2005) 6, pp. 325–328
- [10] *Matlock D. K., Krauss G., Speer J.G.*: Journ. of Mat. Proc. Techn., 117 (2001), pp. 324–328
- [11] *Jahazi M., Eghbali B.*: Journ. of Mat. Proc. Techn., 113 (2001), pp. 594–598
- [12] *Balart M.J., Davis C.L., Strangwood D.*: Materials Science and Engineering A, 328 (2002), pp. 48–57
- [13] *Burakowski T.*: Poradnik inżyniera – obróbka cieplna stopów żelaza. PWN, Warszawa 1977
- [14] *Dziedzic M., Skubisz P.*: Materiały konferencyjne “Walcownictwo 2005”. III Konferencja Naukowa, Ustroń 19–21 października 2005, pp. 273–278
- [15] *Biba N., Stebounov S., Lishiny A.*: Cost effective implementation of forging simulation. Journ. of Mat. Proc. Techn., 113 (2001), pp. 34–39

Received
December 2006

