

Krzysztof Muszka*, Janusz Majta**, Łukasz Bienias*

EFFECT OF GRAIN REFINEMENT ON MECHANICAL PROPERTIES OF MICROALLOYED STEELS

Notation

- d – grain size; μm
- SD – standard deviation
- YS – yield strength; MPa
- TS – tensile strength; MPa
- YS/TS – yield ratio
- T – temperature; $^{\circ}\text{C}$
- T_R – reheating temperature; $^{\circ}\text{C}$
- T_D – deformation temperature; $^{\circ}\text{C}$
- A_{R3} – austenite-ferrite transformation start temperature; $^{\circ}\text{C}$
- ITT – impact transition temperature; $^{\circ}\text{C}$
- CR – cooling rate; K/s, $^{\circ}\text{C/s}$
- σ'_0 – the Peierls-Nabarro stress; MPa
- σ_{ss} – solid solution strengthening; MPa
- σ_p – precipitation strengthening; MPa
- σ_g – grain boundary strengthening; MPa
- σ_{sg} – subgrain strengthening; MPa
- σ_d – dislocation strengthening; MPa
- σ_t – texture strengthening; MPa
- UFF – ultra fine ferrite
- UFG – ultra fine-grained
- x – distance from the origin on the cross section of the specimen after rolling; mm
- HVs – Vickers hardness near the surface layer of rolled specimen
- HVo – Vickers hardness in the middle layer of rolled specimen

* M.Sc.; ** Ph.D., D.Sc.: Faculty of Metals Engineering and Industrial Computer Science, AGH University of Science and Technology, Krakow, Poland; muszka@agh.edu.pl; majta@metal.agh.edu.pl

1. INTRODUCTION

The grain refinement is one of the most effective strengthening mechanism, improving mechanical properties without loss in ductility. It is well known, however, that proper prediction of mechanical properties of fine grained materials is much more complicated because of different deformation and strengthening mechanisms operating in these materials. When the strong grain refinement (below 1 micron) is achieved, some deviations, comparing to the conventional materials have been reported i.e. change in Hall-Petch slope [1], different deformation and fracture mechanisms [2, 3], enhanced strain rate sensitivity or lack in the work [4, 5]. Unfortunately, these phenomena and their physical basis are still poorly understood and most of the well known constitutive laws (i.e. Hall-Petch relationship) are no longer effective in description of the deformation process of such materials. Thus, the proper understanding of specific mechanisms by which the plastic deformation leads to a refined grain size is of paramount importance.

There is a need to systematically correlate chemical composition, the evolution of deformation microstructure, amount of deformation, heat treatment profile, average grain size distribution and texture on the deformation mechanisms operating in submicron/nano materials during processing. Moreover, reliable constitutive description allowing to predict mechanical behavior of very fine-grained materials seems to be very important issue.

It is well known that specific mechanical properties of metal products are the basic requirements from the receiver's point of view. These properties can be obtained as a result of a number of strengthening mechanisms, which act together during deformation process. Depending on chemical composition of the material, type of crystallographic lattice, and deformation parameters they could be classified as [6]:

- the Peierls-Nabarro stress due to the inherent friction stress of the material which must be exceeded to allow easy dislocation glide, σ'_0 ;
- solid solution strengthening (alloying elements), σ_{ss} ;
- dispersion strengthening (precipitation hardening), σ_p ;
- grain boundary and subgrain strengthening, σ_g , σ_{sg} ;
- dislocations strengthening (from forest of dislocations), σ_d ;
- textural strengthening, σ_t .

The contribution of strengthening components strongly depends on the chemical composition of the material, its deformation history and resulting microstructure.

It is well known, that amongst the different methods of mechanical properties improvement, only strong grain refinement leads to an increase in strength of the material without any significant drop in its toughness and ductility. Moreover, this strengthening method seems to be especially attractive because it doesn't require a usage of expensive alloy additions and still existing production technology can be used. For example, obtaining the UFF structure in low carbon steel, beside the increase in mechanical properties, leads also to decrease in the *ITT* temperature and improves the weldability, whereas in microalloyed steel leads to additional increase in its strength.

2. EXPERIMENTAL PROCEDURES

In the present study, the influence of grain size on mechanical properties was studied. The low carbon and microalloyed steels have been selected. The chemical compositions are summarized in Table 1. The range of different grain sizes was developed using single-pass hot rolling experiments. Samples had dimensions 140×40×15 mm (length, width, thickness). The deformation schedules were evaluated in order to involve different phenomena (static and dynamic recrystallization, dynamic strain induced transformation) using thermo-mechanical treatment and finally to obtain the range of grain sizes from approx. 12 down to 2 micrometers. The T_R temperature was determined as follows: samples were austenitized at different temperatures (900, 950, 1000, 1050°C) for 300 s, then quenched and polished. Their microstructures were revealed using picric acid solution. The austenite grain size was then measured using mean linear intercepts method. The temperatures were chosen in order to prevent the grain growth during reheating.

Table 1. Chemical composition of investigated steels

Steel	C	Mn	Si	Nb	Ti	V	Al	Mo	Cu	Cr	Ni
A (250)	0.15	1.0	0.14	0.0015	0.002	0.002	0.031	0.002	0.011	0.016	0.022
B (X65)	0.07	1.6	0.31	0.07	0.02	0.01	0.035	0.3	0.02	0.02	0.03

The continuous cooling deformation procedure was carried out to determine the A_{r3} temperature for a given thermomechanical condition using hot torsion testing. The steel was reheated to a given austenitization temperature and held for a given time. This method has been described in [7]. It was then cooled down at a constant cooling rate of 0.5 K/s to a temperature that was higher than any critical temperature encountered during cooling from the reheat temperature. A constant strain rate (0.001 s^{-1}) was then applied continuously and the sample was further cooled at 0.5 K/s until the specimen temperature dropped significantly below the A_{r3} . The A_{r3} temperatures were found to be 778°C for steel A and 799°C for steel B.

The rolling tests were carried out according to the schedule showed in Tables 2 and 3.

Table 2. Thermomechanical treatment parameters for steel A

Specimen	T_R , °C	T_D , °C	Strain	CR, °C/s
A1	900	900	0.51 (40%)	0.2
A2	1200	750	0.91 (60%)	4
A3	900	778	0.51 (40%)	10
A4	900	800	0.51 (40%)	10
A5	900	800	0.70 (50%)	10
A6	1200	750	1.35 (74%)	10
A7	900	800	1.35 (74%)	10

Table 3. Thermomechanical parameters for steel B

Specimen	T_R , °C	T_D , °C	Strain	CR , °C/s
B1	1200	1000	1.05 (65%)	0.2
B2	1200	800	1.05 (65%)	0.2
B3	1200	800	1.05 (65%)	4
B4	1200	840	1.20 (70%)	4
B5	1000	840	1.31 (73%)	4
B6	1000	800	1.31 (73%)	4

Samples were heated to the reheating temperature T_R , held for 300 s then cooled to deformation temperature T_D and rolled. After deformation samples were cooled down to the room temperature using different cooling rates (different cooling mediums had been used: water quenching, air cooling, Super Quench oil, kaowool blanket). The temperature of all rolled samples was measured continuously during the tests by N-type thermocouples, inserted at different positions in the side of samples.

From all strips after rolling samples for microstructure analysis were cut, both in the rolling and transversal direction. The samples then were polished and etched using 2% Nital in order to reveal ferrite microstructures. The grain size measurements were carried out using mean linear intercepts method. At least 300 grains were counted.

The quasi-static mechanical properties were measured using the MTS machine. Two samples were cut from each rolled strip in the rolling direction. The shape and dimensions of the tensile samples are shown in Figure 1a.

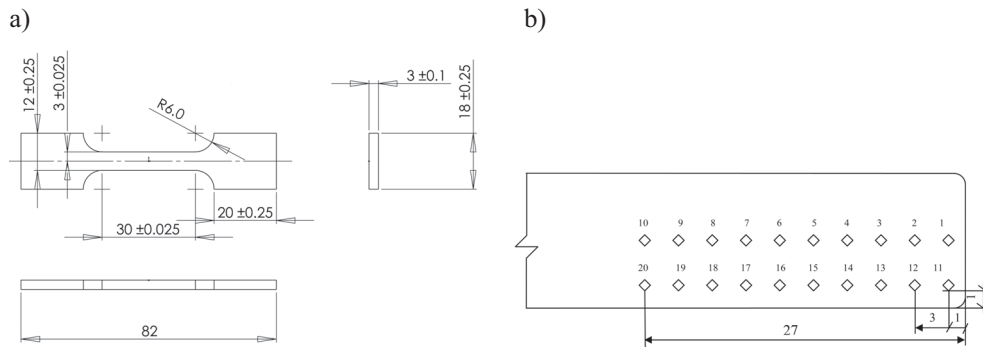

Fig. 1. Tensile sample dimensions (a) indentations distribution for Vickers hardness measurements in specimens after rolling (b)

In order to study the microstructural and mechanical inhomogeneity of rolled specimens, Vickers hardness measurements (5 kG) were carried out on the cross section in transversal direction to the rolling plane. The measurements were performed according to Fig-

re 1b i.e. in the middle of the cross section and near the surface layer. First indentation was done in the middle layer of the transversal cross section, in the distance of 1mm from the specimen's edge, and the following ones were done every 3 mm. Similarly, measurements have been carried out in the layer near to the specimen's surface (1mm from the surface). Next, in order to estimate the mechanical properties inhomogeneity level, the diagrams of HV5 vs. distance from the origin. Also, the HVs/HVo for all the specimens from both steels. The example results are shown in Figures 5 and 6. Basic observations, concerning effect of grain size, chemical composition, and thermomechanical history on microstructural and mechanical inhomogeneity are summarized in Table 6.

3. RESULTS

The influence of thermomechanical parameters on grain refinement is clearly shown in Figure 2, which presents chosen microstructures of A steel after hot rolling experiments. The optical microphotographs were taken in the rolling direction. The strongest refinement of the microstructure was achieved for sample deformed just above A_{r3} temperature (Fig. 2b). Samples deformed after reheating to higher T_R temperature (with more coarse austenite initial structure) have more inhomogeneous structures than samples with finer initial austenite microstructure. The increase in strain caused also grain refinement, however even strain of 1.35 (74% of reduction) was insufficient to obtain strain induced dynamic transformation ferrite. Thus, more experiments towards further grain refinement including multipass rolling are necessary.

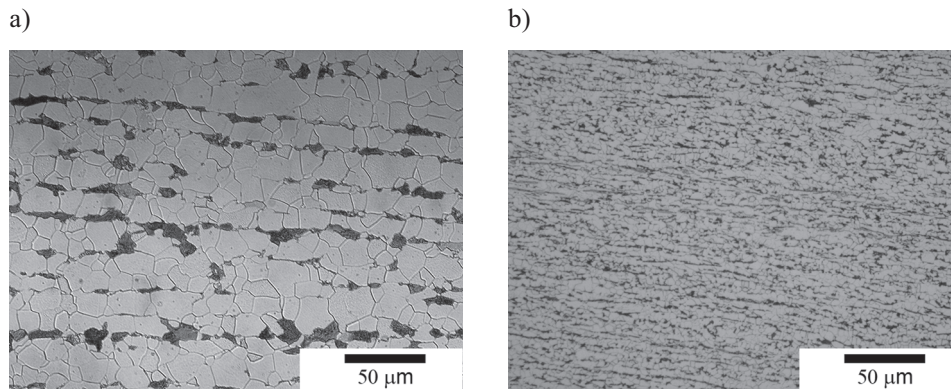

Fig. 2. Examples of microstructures after hot rolling of A steel: specimen A1 (a); specimen A7 (b)

Similar results were obtained for microalloyed steel. Figure 3 shows its chosen microstructures after hot rolling. The effect of deformation parameters (reheating and deformation temperature, strain) in general is similar comparing to the previous grade of steel. However, the level of grain refinement achieved in this case (specimen B6) was lower, what may be caused by decreased cooling rate.

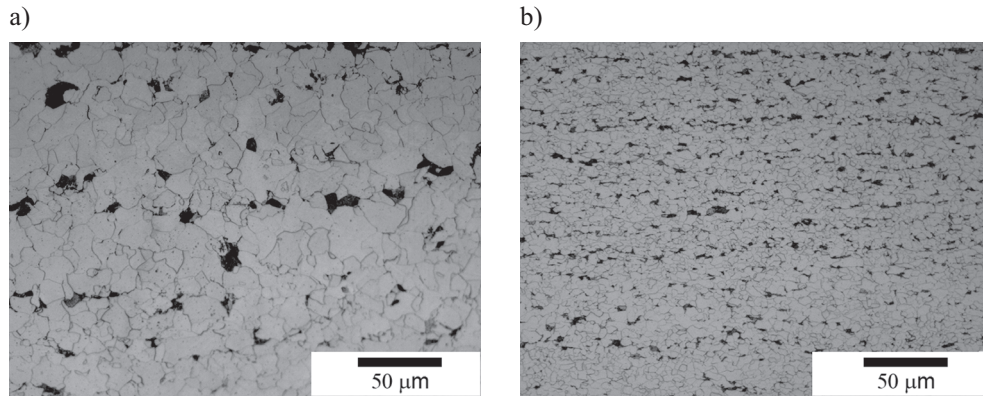

Fig. 3. Examples of microstructures after hot rolling of B steel: specimen B1 (a); B6 (b)

Results of grain size measurements and quasi-static tensile test are summarized in Tables 4 and 5. Figure 4 shows the grain size vs. yield strength (*YS*) and tensile strength (*TS*) for both steel grades. Presented here results of low carbon steel (steel A) are typical i.e. the Hall-Petch slope seems to be reasonable both for *YS* and *TS*. Some deviation is observed in the case of microalloyed steel (steel B). In this case the precipitation hardening phenomena as well as solid solution strengthening seems to influence the mechanical behavior of the specimens.

Table 4. Results of grain size measurements and quasi-static tensile test of A steel

Specimen	d (SD), μm	<i>YS</i> , MPa	<i>TS</i> , MPa	<i>YS/TS</i>
A1	12.79 (6.58)	288	443	0.65
A2	10.81 (5.87)	376	498	0.76
A3	7.57 (5.84)	400	530	0.76
A4	6.12 (3.34)	388	505	0.77
A5	5.22 (2.85)	392	523	0.75
A6	3.96 (2.14)	431	552	0.78
A 9	2.44 (1.48)	500	551	0.91

Table 5. Results of grain size measurements and quasi-static tensile test of B steel

Specimen	d (SD), μm	<i>YS</i> , MPa	<i>TS</i> , MPa	<i>YS/TS</i>
B1	12.34 (6.11)	395	489	0.81
B2	10.09 (6.01)	463	524	0.88
B3	8.53 (5.05)	502	561	0.90
B4	5.28 (3.53)	504	563	0.89
B5	4.13 (2.14)	400	483	0.83
B6	3.02 (1.53)	450	509	0.88

Two samples with the smallest grain size were reheated to lower T_R (1000°C), which caused that less amount of Nb dissolved and, therefore, had less precipitation hardening effect.

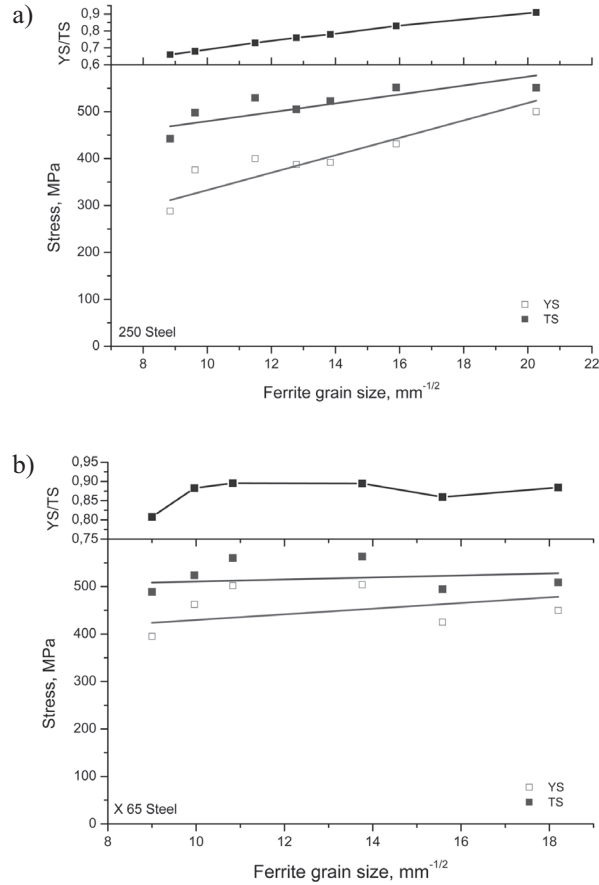

Fig. 4. Measurements of yield strength, tensile strength and yield ratio vs. grain size – A steel (a); B steel (b)

Basing on hardness measurements performed at the cross section of rolled specimens (in transversal direction to RD), it can be concluded that specimens with more coarse structure represent higher inhomogeneity of mechanical properties. Specimens, where the structure refinement level was significantly higher, have more homogeneous microstructure as well as mechanical properties along the measured distance (see Fig. 5 and 6).

Simultaneously, much higher properties are observed in these specimens near the surface layer, what can be attributed to the application of increased deformation (approx. 1.3) that involves high shear stresses, having principal influence on microstructural effects. Very often similar shear stresses are used in obtaining nanocrystalline and nanostructural materials using severe plastic deformation techniques [8–10].

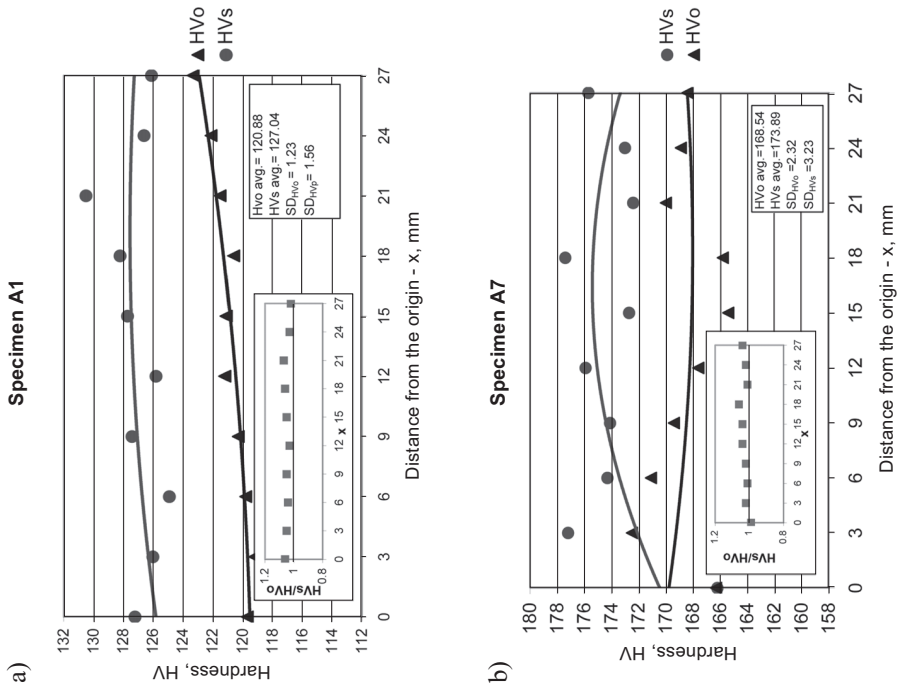

Fig. 5. Hardness vs. distance from the origin for specimen A1 (a) and A7 (b)

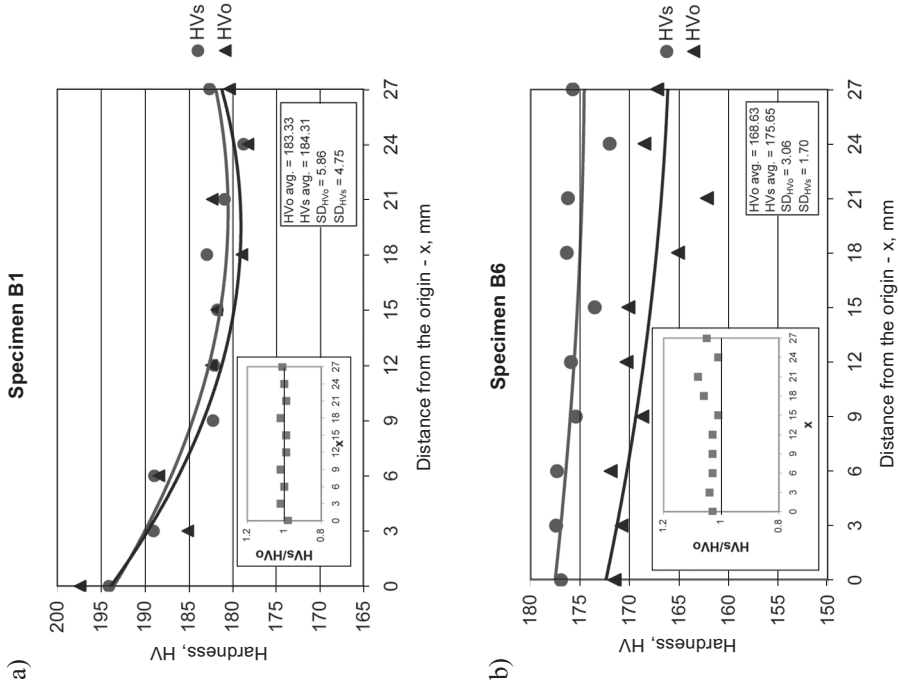

Fig. 6. Hardness vs. distance from the origin for specimen B1 (a) and B6 (b)

Examples of stress-strain curves obtained in quasi-static tensile tests are presented in Figure 7. Mechanical behavior of analyzed here specimens is a summary of the effect of finish deformation temperature, strain and cooling rate on the ferrite grains observed within the final structure. Presented in Figure 7 results indicate that for both steels the thermomechanical history can effectively affect the mechanical properties, first of all the strength.

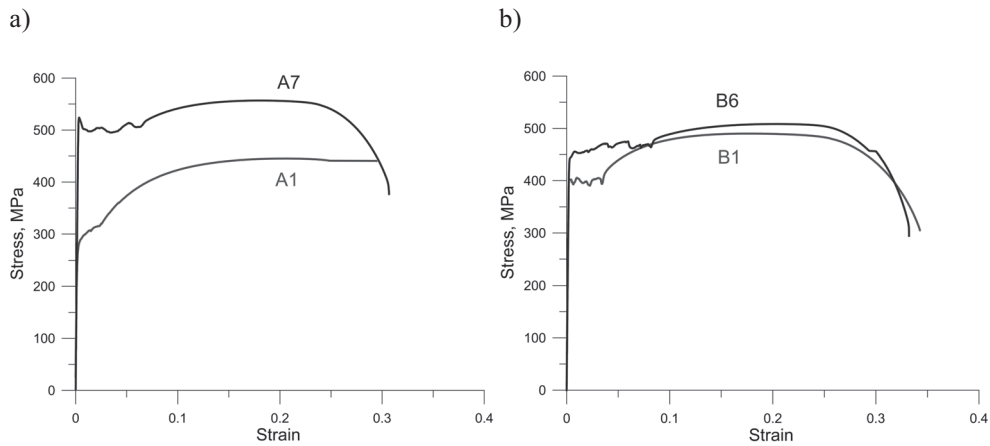

Fig. 7. Quasi-static tensile test results for selected specimens: A1, A7 (a) and B1, B6 (b)

Table 6 summarizes all of the original observations collected during present analysis. It can be stated that obtained by thermomechanical treatment grain refinement leads improved mechanical properties and also to increased homogeneity of the final microstructure.

Table 6. Effect of chemical composition and thermomechanical processing on mechanical properties, mechanical properties inhomogeneity and microstructure of the investigated steels

Specimen	Mechanical properties, HV	Properties homogeneity	Microstructure
1	2	3	4
A1	Increase of HVs i HVo along the measured distance. Homogeneous increase of HVp/HVo	Constant increase of HVs and HVo along measured distance	Coarse-grained, homogeneous
A2	Increase of HVs, decrease of HVo along measured distance. Inhomogeneous increase of HVs/HVo	Inhomogeneous increase of HVs along measured distance, inhomogeneous decrease of HVo along measured distance	Coarse-grained, homogeneous
A3	Decrease of HVs and HVo along measured distance. Inhomogeneous increase of HVs/Hvo	Constant decrease of HVs and HVo along measured distance	Inhomogeneous: coarse- and fine-grained

Table 6 cont.

Specimen	Mechanical properties, HV	Properties homogeneity	Microstructure
1	2	3	4
A4	Increase of HVo, decrease of HVs along measured distance. Inhomogeneous decrease of HVs/HVo	Inhomogeneous increase of HVo along measured distance, inhomogeneous decrease of HVs along measured distance	Fine-grained, homogeneous
A5	Inhomogeneous increase of HVo, inhomogeneous decrease of HVs along measured distance. Inhomogeneous increase of HVs/HVo	Initial increase, later decrease of HVs. Initial decrease, later increase of HVo along measured distance	Fine-grained, homogeneous
A6	Inhomogeneous decrease of HVs and HVo Along measured distance. Almost constant ratio of HVs/HVo	Initial increase, later decrease of both HVs and HVo along measured distance	Fine-grained, homogeneous
A7	Inhomogeneous increase of HVs, inhomogeneous decrease of HVo along measured distance. Inhomogeneous increase of HVs/HVo	Initial increase, later decrease of HVs. Decrease of HVo along measured distance	Ultra fine-grained, homogeneous
B1	Increase of HVo and decrease of HVs along measured distance. Inhomogeneous decrease of HVs/HVo	Inhomogeneous increase of HVo and inhomogeneous decrease of HVs along measured distance	Coarse-grained, inhomogeneous
B2	Decrease of HVs and HVo along measured distance. Inhomogeneous increase of HVs/HVo	Inhomogeneous decrease of both HVs and HVo along measured distance	Coarse-grained, homogeneous
B3	Inhomogeneous decrease of HVp and HVo along measured distance. Insignificant increase of HVs/HVo	Initial, decrease and later increase of HVs and HVo along measured distance	Coarse-grained, homogeneous
B4	Decrease of HVo and HVs along measured distance. Homogeneous increase of HVs/HVo	Inhomogeneous decrease of HVo and HVs along measured distance	Fine-grained, homogeneous
B5	Clear increase of HVs and HVo along measured distance. Homogeneous increase of HVs/HVo	Initial decrease and later increase of HVp and HVo	Fine-grained, homogeneous
B6	Decrease of HVs and HVo along measured distance. Significantly higher value of HVs. Inhomogeneous increase of HVs/HVo	Constant decrease of HVs and HVo along measured distance	Ultra fine-grained, homogeneous

4. CONCLUSIONS

The experimental results confirm the previous theoretical assumptions and show that the mechanical response of low carbon and microalloyed steels strongly depends on thermo-mechanical history and ferrite grain size. In the case of quasi-static deformation, the mechanical properties of the material can be fully controlled by processing parameters (strain, strain rate, deformation temperature and cooling rate). However obtained level of grain refinement didn't cause any significant deviations in material behavior comparing to coarse-grained microstructures. Thus, the next step of study will be focused on obtaining higher level of grain refinement.

Acknowledgements

The financial support of the Polish Committee for Scientific Research (Research project KBN no. 3 T08B 042 27) is gratefully acknowledged.

REFERENCES

- [1] Nes E., Marthinsen K., Holmedal B.: The effect of boundary spacing on substructure strengthening. *Materials Science and Technology*, 20 (2004), pp. 1377–1382
- [2] Hansen N.: Boundary strengthening in undeformed and deformed polycrystals. *Materials Science and Engineering A*, 409 (2005), pp. 39–45
- [3] Hansen N.: Hall–Petch relation and boundary strengthening. *Scripta Materiala*, 51 (2004), p. 801
- [4] Majta J., Pietrzyk M., Lenard J.G.: A study of the effect of the thermomechanical history on the mechanical properties of a high niobium steel. *Materials Science and Engineering: A*, 208 (1996), p. 249
- [5] Huang S., Khan A.S.: Modeling the Mechanical Behavior of 1100–0 Aluminum at Different Strain Rates by the Bodner-Partom Model. *International Journal of Plasticity*, 8 (1992), p. 501
- [6] Majta J.: Complete model for niobium-microalloyed steels deformed under hot working conditions. *Thermomechanical Processing of Steels*, London, 2000, IOM Communications, The Chameleon Press Ltd., Vol. 1, p. 322
- [7] Belladi H.: Ultrafine Ferrite Formation in Steels Through Thermomechanical Processing. Ph.D. Thesis, Deakin University, Geelong, Vict, Australia 2004
- [8] Umamoto M., Todaka Y., Tschuiya K.: Nanocrystallization of Steels by Various Severe Plastic Deformation. *MS&T 2003, Processing and Properties of Structural Nanomaterials*, pp. 126–132
- [9] Inoue K., Tsui N., Saito Y.: Ultra-Grain Refinement of 36%Ni Steel by Accumulative Roll-Bonding (ARB) Process. (ISUG 2001), Eds. S. Takaki and T. Maki, Fukuoka, Japan, 2001, pp. 126–129
- [10] Lowe T.C., Valiev R.Z.: The use of Severe Plastic Deformation Techniques in grain refinement. *JOM A* publication of The Minerals, Metals & Materials Society, October 2004, pp. 64–68

