

ARKADIUSZ SZYMCZAK*, MACIEJ PASZYŃSKI*, DAVID PARDO**

GRAPH GRAMMAR BASED PETRI NET CONTROLLED DIRECT SOLVER ALGORITHM

In this paper we present the Petri net setting the optimal order of elimination for direct solver working with hp refined finite element meshes. The computational mesh is represented by a graph, with graph vertices corresponding to finite element nodes. The direct solver algorithm is expressed as a sequence of graph grammar productions, attributing the graph vertices. The Petri net dictates the order of graph grammar productions, representing the execution of the solver algorithm over a graph representation of computational mesh. The presentation is concluded with numerical experiments performed for a model L-shape domain.

Keywords: *Petri nets, graph grammar, direct solver*

ALGORYTM SOLVERA DOKŁADNEGO STEROWANY SIECIĄ PETRIEGO WYKORZYSTUJĄCY GRAMATYKI GRAFOWE

W artykule przedstawiona została sieć Petriego sterująca kolejnością wykonania produkcji gramatyki grafowej reprezentującej wykonanie algorytmu solvera dokładnego na h adaptowanej siatce metody elementów skończonych. Siatka obliczeniowa przedstawiona została w postaci grafu, którego wierzchołki odpowiadają węzłom elementów skończonych. Algorytm solvera dokładnego wyrażony jest w postaci sekwencji produkcji gramatyki grafowej, atrybutujących wierzchołki grafu. Sieć Petriego określa kolejność wykonania produkcji gramatyki grafowej, reprezentujących wykonanie algorytmu solvera na grafowej reprezentacji siatki obliczeniowej. Artykuł podsumowuje eksperyment numeryczny dotyczący wykonanie algorytmu solvera na problemie modelowym w kształcie litery L.

Słowa kluczowe: *sieci Petriego, gramatyki grafowe, solwery dokładne*

* Department of Computer Science, AGH University of Science and Technology, al. Mickiewicza 30, 30-059, Kraków, Poland, maciej.paszynski@agh.edu.pl

** Departamento de Matemática Aplicada, Estadística e Investigación Operativa, UPV/EHU, Campus de Leioa, Vizcaya, and IKERBASQUE (Basque Foundation for Sciences), Bilbao, Spain

1. Introduction

The paper presents the part of a direct solver algorithm that consists of finding an optimal order of elimination for hp refined Finite Element Method (FEM) computational meshes. The algorithm is expressed in terms of graph grammar controlled by Petri nets. The process of generation of computational mesh for FEM was expressed by graph grammar for two dimensional rectangular [3], two dimensional triangular [4], as well as three dimensional tetrahedral elements [5]. The order of execution of graph grammar productions can be expressed by control diagram [11] or, alternatively, by Petri nets [6, 7]. The Petri nets model allows to analyze the correctness as well as potential for deadlock or starvation of the considered algorithms.

In this paper we focus on modeling the solver algorithm by using graph grammar based Petri nets. To illustrate it, we utilize the two dimensional L-shape domain model problem [1, 2], solved by using h refined two dimensional rectangular finite element mesh with uniform polynomial order of approximation p .

The frontal solver is a sophisticated implementation of a Gaussian elimination algorithm suitable for sparse matrices [9]. It browses finite elements one by one, aggregating the element local matrices into a single frontal matrix, and eliminating fully assembled degrees of freedom. The multi-frontal solver [10] is a generalization of a frontal solver algorithm by using multiple frontal matrices. It can be efficiently used whenever the elimination tree is created, with frontal matrices assigned to the elimination tree nodes. During the execution of a multi-frontal solver algorithm, the elimination tree is processed, and frontal matrices coming from son nodes are merged at parent nodes into a new single frontal matrix. The process is recursively repeated until we reach the root of the elimination tree.

The process of mesh generation and h refinement expressed in terms of graph grammar results in a graph representation of the computational mesh. The solver algorithm will be expressed in terms of graph grammar productions controlled by the Petri nets.

2. L-shape domain model problem

In this section we introduce the L-shape domain model problem [1, 2]. The problem consists in solving Laplace equation

$$\Delta u = 0 \text{ in } \Omega \tag{1}$$

over the L-shape domain Ω presented in Figure 1. The solution $u: R^2 \supset \Omega \ni u \mapsto R$ is a temperature distribution inside the L-shape domain.

The zero Dirichlet boundary condition

$$u = 0 \text{ on } \Gamma_D \tag{2}$$

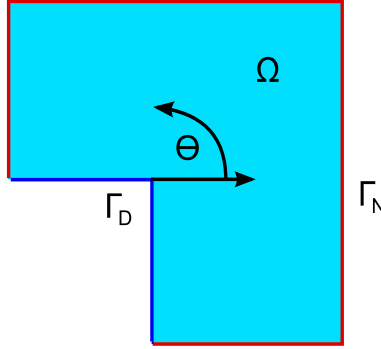

Fig. 1. The L-shape domain

is assumed on the internal part of the boundary Γ_D . The Neumann boundary condition

$$\frac{\partial u}{\partial n} = g \text{ on } \Gamma_N \quad (3)$$

is assumed on the external part of the boundary Γ_N . The exact solution with the origin point located at O (Fig. 1) is given by:

$$g(r, \theta) = r^{\frac{2}{3}} \sin \frac{2}{3} \left(\theta + \frac{\pi}{2} \right). \quad (4)$$

The so-called *strong form* of the partial differential equation (PDE) (1-3) is transformed into *weak (variational) form* of PDE

$$b(u, v) = l(v) \quad \forall v \in V, \quad (5)$$

$$b(u, v) = \int_{\Omega} \nabla u \nabla v dx, \quad (6)$$

$$l(v) = \int_{\Gamma_N} g v dS \quad (7)$$

by considering $L^2(\Omega)$ scalar products of (1) with test functions from the functional space V

$$V = \{v \in L^2(\Omega) : \int_{\Omega} (\|v\|^2 + \|\nabla v\|^2) dx < \infty : tr(v) = 0 \text{ on } \Gamma_D\}, \quad (8)$$

integrating by parts, and including boundary condition (3).

The *Finite Element Method* consists in constructing a subspace $V_{hp} \subset V$ with finite dimensional basis $\{e_{hp}^i\}_{i=1, \dots, N_{hp}}$. The subspace V_{hp} is constructed by partitioning the domain Ω into finite number of elements, and defining basis functions at finite element vertices, over edges, and interiors. The exemplary partition of the L-shape domain into three rectangular finite elements is presented in Figure 2.

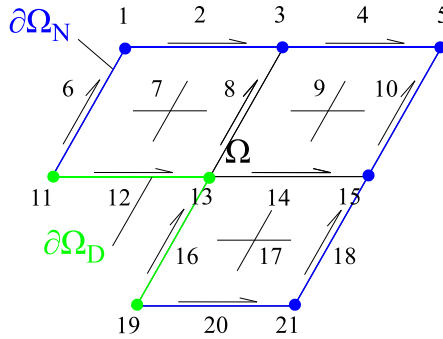

Fig. 2. Partition of the L-shape domain into three finite elements

Elements of the basis e_{hp}^i restricted to a particular element are called *shape functions*. We define the first order shape functions (pyramids) at element vertices, second order shape functions (edge-bubbles) over element edges, and second order shape functions over elements interiors, presented in Figure 3.

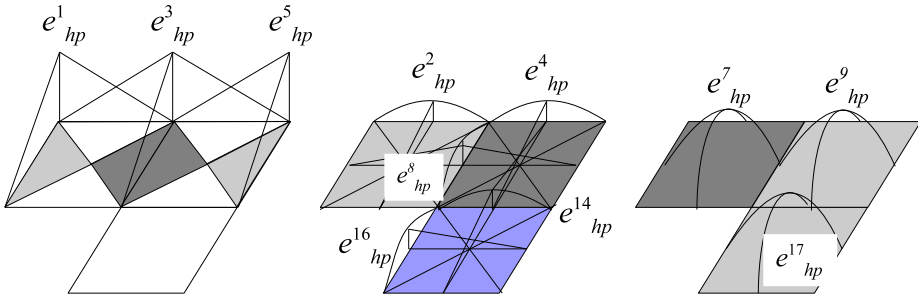

Fig. 3. Examples of vertex, edge and interior shape-functions

The exact solution u of the weak formulation (5)–(7) is approximated in subspace V_{hp} as a linear combination of the basis functions

$$u \approx u_{hp} = \sum_{i=1}^{21} u_{hp}^i e_{hp}^i \quad (9)$$

The coefficients u_{hp}^i are called *degrees of freedom* (d.o.f.). The degrees of freedom can be obtained by solving the following system of equations

$$\sum_{i=1}^{21} u_{hp}^i b(e_{hp}^i, e_{hp}^j) = l(e_{hp}^j) \quad j = 1, \dots, 21 \quad (10)$$

$$b(e_{hp}^i, e_{hp}^j) = \int_{\Omega} \nabla e_{hp}^i \nabla e_{hp}^j dx \quad (11)$$

$$l\left(e_{hp}^j\right) = \int_{\Gamma_N} g e_{hp}^j dS \quad (12)$$

obtained by substituting (9) into (5) and considering $\{e_{hp}^j\}, j = 1, \dots, 21$ test functions.

3. Expressing the solver algorithm by graph grammar production controlled by Petri nets

The direct solver is used to solve the system of linear equation (10)–(12). Following [12, 13] the general idea of the solver is summarized in Figure 4. The solver discussed in [12, 13] creates two frontal matrices for each refinement tree. The solver browses elements from refinement tree from the bottom to the top, aggregates d.o.f. from elements nodes to frontal matrices, and eliminates d.o.f. related to fully assembled nodes. The situation presented in Figure 4 corresponds to the case where two leaf elements have been already aggregated to two frontal matrices, and their interior nodes have been eliminated. Now, the solver have aggregated three new elements to each frontal matrix, located one level up at the refinement tree. The fully assembled nodes that can be eliminated now are denoted by yellow color for the first frontal matrix, and by brown color for the second frontal matrix. The not fully assembled nodes are denoted by green and blue colors. The disadvantage of this method is the fact that the number of not fully assembled d.o.f. on the border of two refined elements is constantly growing while we go up the refinement tree. This results in constant increase of the size of each of the two frontal matrices, which in turns slows down the solver algorithm. These nodes will be eliminated at the very end, when we reach the roots of the two refinement trees, and the two frontal matrices will be merged. The alternative strategy proposed in this paper is to merge frontal matrices coming from neighboring refinement trees *before* going up the refinement tree. The idea is illustrated in Figure 5. This simple trick results in constant size of the frontal matrix.

We focus on the computational mesh presented in Figure 6 for the L-shape domain problem, h refined in the direction of the central singularity. The graph representation of $1/3$ of such a mesh, corresponding to any of the three initial mesh elements, four times h refined, is presented in Figure 7. The graph can be obtained by executing a sequence of graph grammar productions described in [11]. The full graph for the three refined elements is too large to be presented in a figure here.

There are five graph grammar productions responsible for execution of the direct solver algorithm, presented in Figures 8–12.

The productions attribute by α or β symbols the graph vertices representing element interiors, edges and vertices. The symbols represent the aggregation into a frontal matrix, and the elimination of the node, for different levels of the refinement tree.

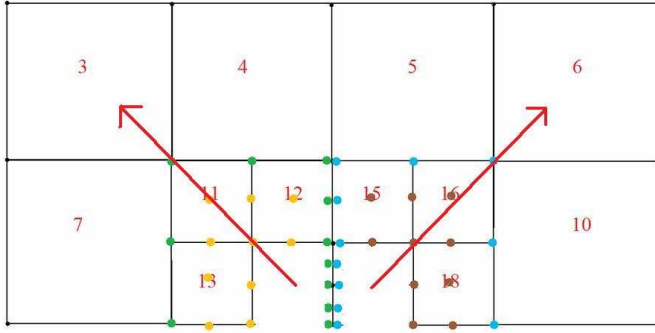

Fig. 4. Following the refinement trees results in increase of the size of the frontal matrix. Green and blue colors denote the growing number of border nodes

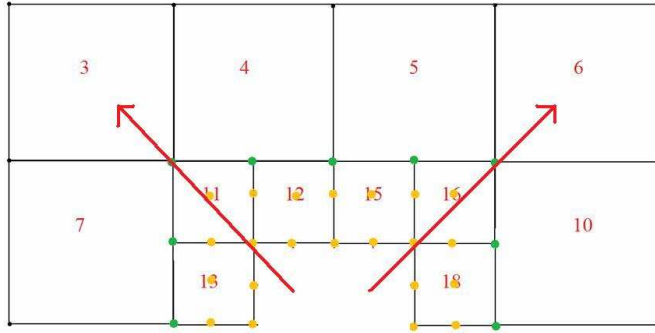

Fig. 5. Merging the frontal matrices and elimination of the border d.o.f. results in the constant size of the frontal matrix. Green color denotes the constant number of border nodes

Figure 13 presents the Petri net modeling the elimination process of the solver algorithm. The sequence of elimination is represented by attributing the adaptation tree.

The analyzed example is a L-shaped mesh comprising three initial elements. The elements are numbered from 1 to 3 such that the middle element has number 2. N is the number of adaptation levels and, in the analyzed example, $N = 4$. The transitions are named after graph grammar productions they represent. The numbers after dash in the transition names designate the number of the mesh element being attributed by given transition. The elimination process is performed in different stages: first, production **P0** is executed, then all **P1** productions are executed, second all **P3** and so on. Productions attributing adjacent mesh elements (1 and 2 or 2 and 3) modify vertices representing the common edge between the elements – therefore such production pairs cannot be executed in parallel.

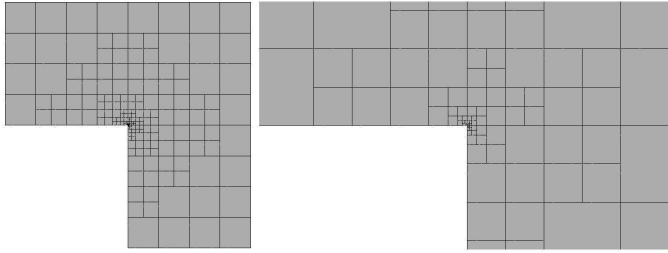

Fig. 6. Left panel: 20 times h refined mesh for the L-shape domain problem. Right panel: Amplification by a factor of 10 towards the central singularity

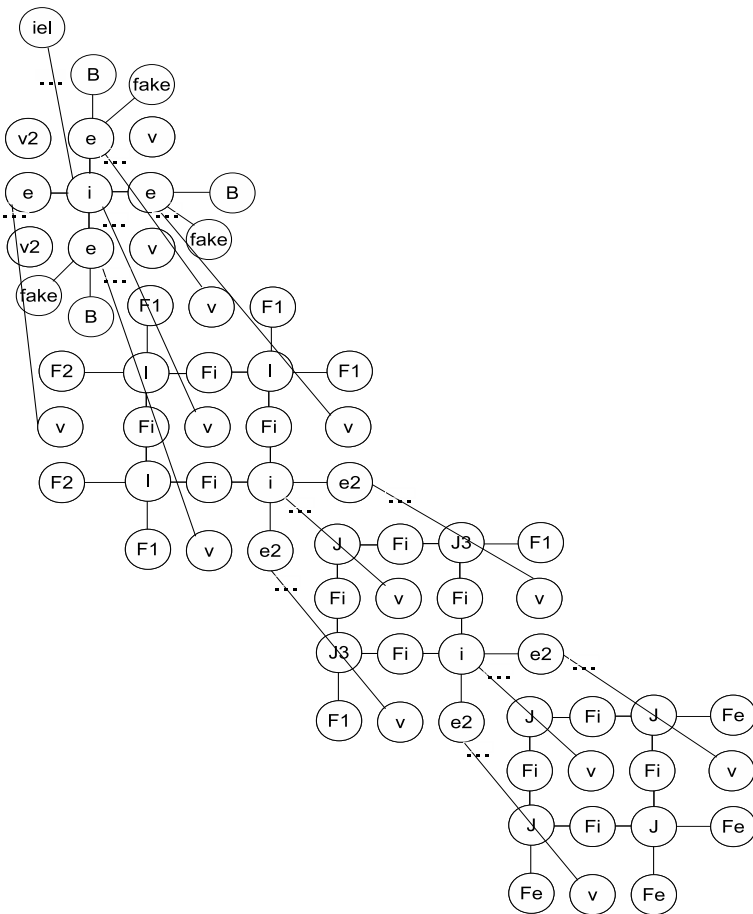

Fig. 7. Graph representation of 1/3 of the mesh for the L-shape domain problem, after four h refinements

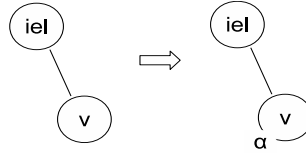

Fig. 8. Graph grammar production **PO** attributing the corner vertex

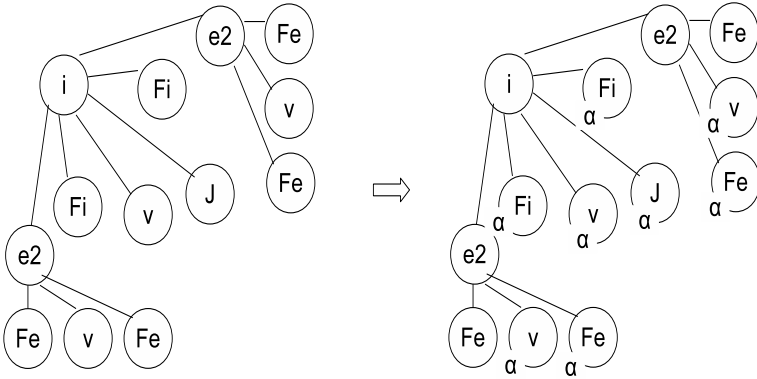

Fig. 9. Graph grammar production **P1** attributing the leaf of the refinement tree

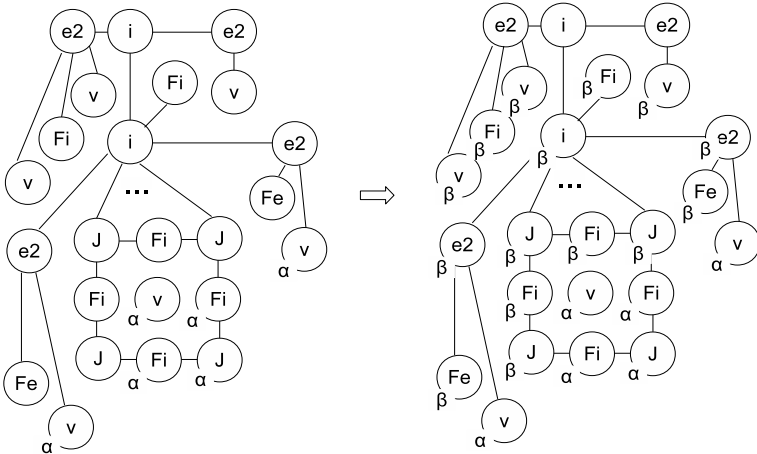

Fig. 10. First graph grammar production **P3** propagating the elimination from son to parent nodes in the refinement tree

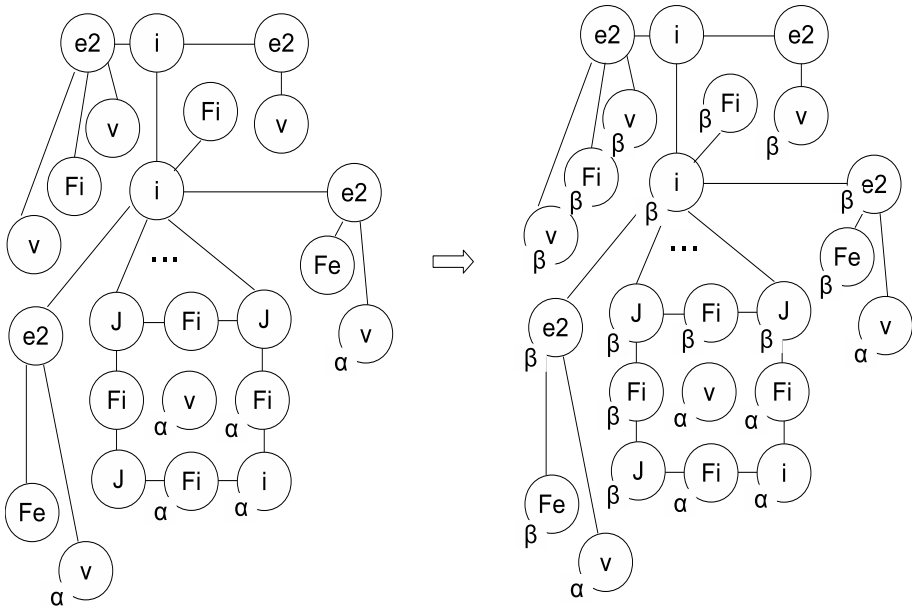

Fig. 11. Second graph grammar production **P4** propagating the elimination from son to parent nodes in the refinement tree

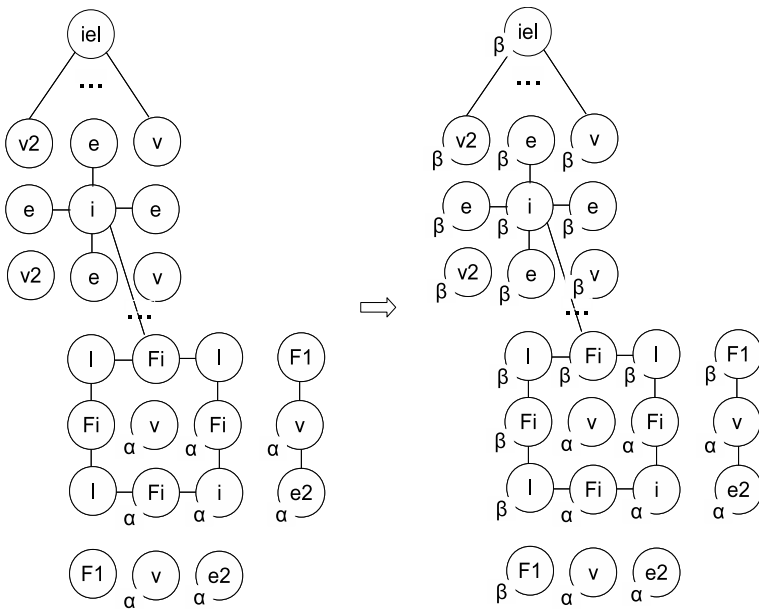

Fig. 12. Graph grammar production **P5** completing the elimination process

Places P2, P4, P7, P9, P13, P16, P19, and P20 with initial marking of one token ensure mutual exclusion of the transitions corresponding to conflicting productions. Places P11, P15, and P18 determine the number of executions of production **P4** for each element of the initial mesh. In the analyzed example (4 adaptation levels) the round of **P4** productions should be repeated twice, therefore these places contain 2 tokens each in the initial marking.

Figure 14 presents the reachability graph generated with Platform Independent Petri Net Editor for the Petri net presented in Figure 13 and initial marking of (1, 0, 1, 0, 1, 0, 0, 1, 0, 1, 0, 2, 0, 1, 0, 2, 1, 0, 2, 1, 1, 0) (a number at given position indicates the number of tokens in the corresponding place). This graph has been analyzed for deadlock occurrence with the same software. To enable such analysis, one additional place (P21) and transition (T15) have been artificially added to the Petri net. Thanks to this addition, the net becomes live if a dead state cannot be reached elsewhere. The analysis proved that the Petri net is live indeed so there is no risk of deadlock in so defined elimination algorithm.

4. Numerical experiments

The solver algorithm has been executed for the L-shape domain problem, over a computational mesh that has been 20 times h refined in the direction of central singularity, see Figure 6. The polynomial order approximation has been uniformly set to p over the entire mesh. Thus, the resulting number of d.o.f. is $(p - 1)^2$ in element interiors, $p - 1$ over element edges and 1 at element vertices. The sequence of experiments has been performed for $p = 2, 3, 4, \dots, 8$. The execution time of the solver algorithm has been measured, compare Figure 15 with the following parts:

- *partial forward elimination* part, responsible for merging element nodes (deciding which nodes are fully assembled and can be eliminated) as well as for merging of suitable frontal matrices,
- *dgemm* part denoting the time spent by matrix-matrix computations within the LAPACK calls,
- *total* denoting the sum of the two above parts,
- *frontal solver* denoting the total execution time of the algorithm traveling the refinement trees separately, one by one, suffering from the increase of the size of the frontal matrices,
- *integration* corresponding to the total integration time over all finite elements.

Additionally, Figure 16 presents the number of d.o.f. over the computational mesh from Figure 6, for different polynomial orders of approximation $p = 2, 3, 4, \dots, 8$. In other words, we compare our algorithm with the frontal solver and the integration algorithms. The reason why we do not compare the algorithm with the multi-frontal algorithm, e.g. MUMPS [14] is because for the L-shape domain problem with a single singularity there are between one and two fronts just following the refinement tree from the bottom to the top of the refinement trees.

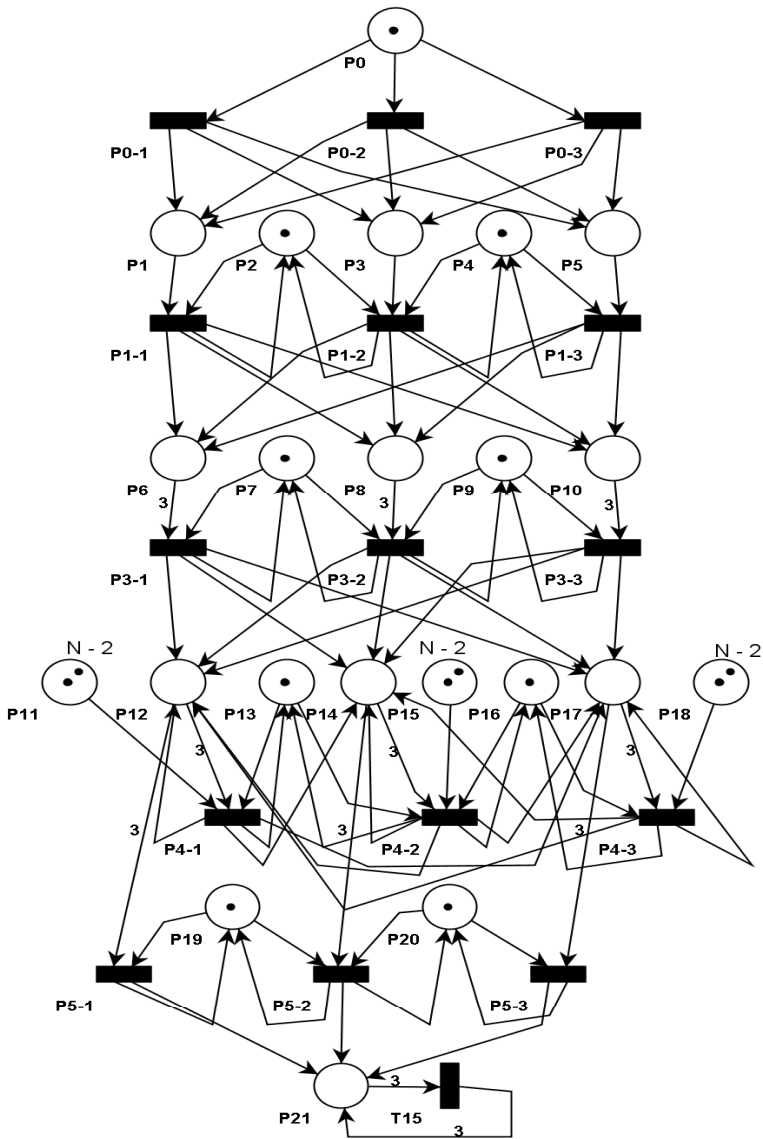

Fig. 13. Petri net setting the order of execution of graph grammar productions expressing the solver algorithm

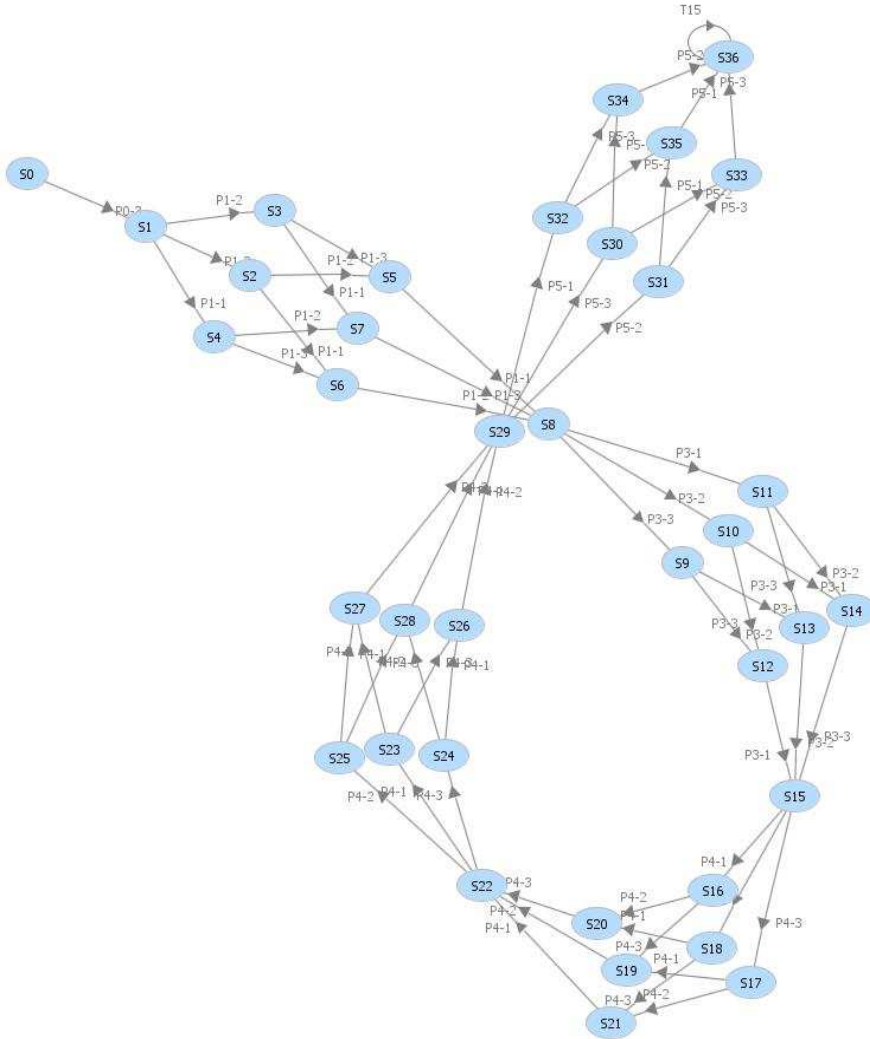

Fig. 14. The linear structure of the reachability graph for the Petri net expressing the solver algorithm. The length of the reachability graph depends on the number of executed refinements

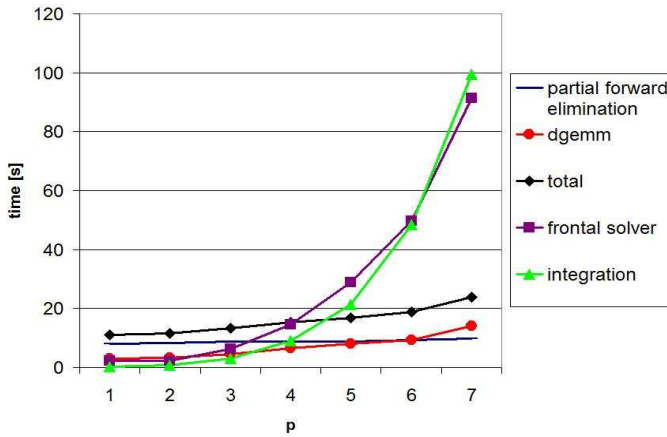

Fig. 15. Execution times for different parts of the Petri nets based solver as well as for the frontal solver and for the integration algorithms

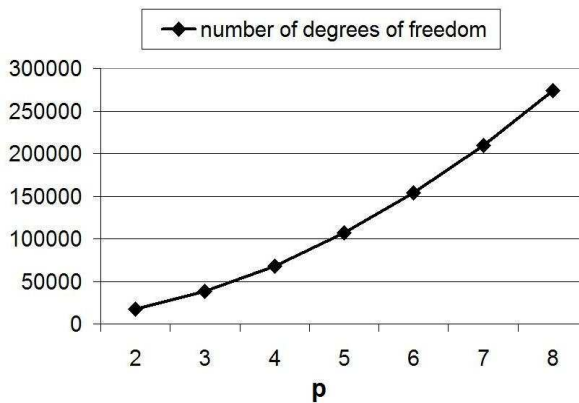

Fig. 16. Sizes of the computational meshes for different polynomial orders of approximation

5. Conclusions

The proposed algorithm scales very well. Actually, the *partial forward elimination* execution time does not depend on p , since the structure of nodes within the mesh does not change when we perform global p refinement. The execution time is increasing slightly for the *LAPACK dgemm* part, but the increase is not so rapid as for the frontal solver algorithm suffering from the constant increase of the size of the frontal matrix. However, the *frontal solver* is faster for small p . This is because the frontal solver algorithm utilized in this example does not work on the level of nodes, rather it works directly on frontal matrix, and the algorithm is free from the overhead resulting

from nodes management. It should be emphasized that for higher p meshes, the nodes management cost becomes negligible in comparison to the actual matrix manipulation time. The proposed algorithm is even faster than the integration algorithm itself. The future work will include the development of the parallel version of the solver, as well as interfacing with more challenging two and three dimensional problems.

Acknowledgements

The work has been supported by Polish MNiSW grant no. NN 519 447739. The work of the third author was partially funded by the Spanish Ministry of Science and Innovation under project MTM2010-16511.

References

- [1] Babuška I., Guo B.: *The hp-version of the finite element method. Part I: The basic approximation results*. Comput. Mech., vol. 1, 1986, pp. 21–41.
- [2] Babuška I., Guo B.: *The hp-version of the finite element method. Part II: General results and applications*. Comput. Mech., vol. 1, 1986, pp. 203–220.
- [3] Paszyński M., Paszyńska A.: *Graph transformations for modeling parallel hp-adaptive FEM computations*. Lecture Notes in Computer Science, vol. 4967, 2007, pp. 1313–1322.
- [4] Paszyńska A., Paszyński M., Grabska E.: *Graph Transformations for Modeling hp-Adaptive Finite Element Method with Triangular Elements*. Lecture Notes in Computer Science, vol. 5103, 2008, pp. 604–614.
- [5] Paszyński M., Pardo D., Paszyńska A.: *Parallel multi-frontal solver for p adaptive finite element modeling of multi-physics computational problems*. Journal of Computational Science, vol. 1, 2010.
- [6] Szymczak A., Paszyński M.: *Graph grammar based Petri nets model of concurrency for self-adaptive hp-Finite Element Method with rectangular elements*. Proc. of Conference Parallel Processing and Applied Mathematics, 2009.
- [7] Szymczak A., Paszyński M.: *Graph grammar based Petri nets model of concurrency for self-adaptive hp-Finite Element Method with triangular elements*. Lecture Notes in Computer Science, vol. 5545, 2009, pp. 845–854.
- [8] Demkowicz L.: *Computing with hp-Adaptive Finite Elements, Vol. I. One and Two Dimensional Elliptic and Maxwell Problems*. Chapman & Hall / CRC Applied Mathematics & Nonlinear Science, 2007.
- [9] Irons B.: *A frontal solution program for finite-element analysis*. International Journal of Numerical Methods in Engineering, vol. 2, 1970, pp. 5–32.
- [10] Duff I.S., Reid J.K.: *The multifrontal solution of indefinite sparse symmetric linear systems*. ACM Transactions on Mathematical Software, vol. 9, 1983, pp. 302–325.

-
- [11] Paszyński M.: *On the Parallelization of Self Adaptive hp-Finite Element Method. Part I. Composite Programmable Graph Grammar Model* Fundamenta Informaticae, vol. 94, 2009, pp. 411–434.
 - [12] Paszyński M., Schaefer R.: *Graph grammar driven parallel partial differential equation solver*. Proc. of Concurrency & Computations, Practise & Experience, 2010.
 - [13] Paszyński M., Pardo D., Torres-Verdin C., Demkowicz L., Calo V.: *A Parallel Direct Solver for the Self-Adaptive hp Finite Element Method*. Journal of Parallel and Distributed Computing, vol. 70, 2010, pp. 255–276.
 - [14] *A MUltifrontal Massively Parallel sparse direct Solver*. <http://www.enseeiht.fr/lima/apo/MUMPS/>.