

RF SIGNAL AMPLITUDE STATISTICS DURING TEMPERATURE CHANGES IN TISSUE PHANTOMS

ELEONORA KRUGLENKO, BARBARA GAMBIN

Institute of Fundamental Technological Research Polish Academy of Sciences
Pawińskiego 5B, 02-106 Warszawa, Poland
ekrug@ippt.gov.pl

Two heating protocols for soft tissue phantoms have been performed. An Agar-Gel-Oil (AGO) mixture has been heated locally by applying ultrasonic beams and a Poly Vinyl Alcohol-cryogel (PVA-c) has been heated “globally” by a water bath with a controlled temperature rise. The RF signals were collected during heating by an ultrasound transducer to ensure no interference from waves from the heating transducer. Independently, the thermocouples' measurement has been used to obtain temperature as a function of time in the AGO case. At first, a compensation of attenuation was performed and normalized envelopes of signals were used as data for statistical analysis. It is shown that random the values of the backscattered amplitude are close to Rayleigh and K-distributed random variables for AGO and PVA-c, respectively. Temperature is linked to the scale parameter of Rayleigh distribution for the AGO, and the shape parameter of K-distribution for PVA-c were calculated and discussed in the context of their suitability for the acoustic measurement of temperature.

INTRODUCTION

The testing of statistical properties of a received signal envelope is now often used as one of the methods for the differentiation of soft tissues in vivo and in vitro, e.g. for diagnostic purposes [1]. Independently, there are papers which concentrate on the study of soft tissue phantoms in order to identify the structural characteristics of the sample material connected with the statistical parameters of the envelope, e.g. [2-5]. A B-scan image did not carry any information about structural changes during the thermal process, at least for a sub-ablation temperature level, so there is a real need to find such changes in other properties in backscattered signals, and then the magnitude of a signal's amplitude, see Fig 1.

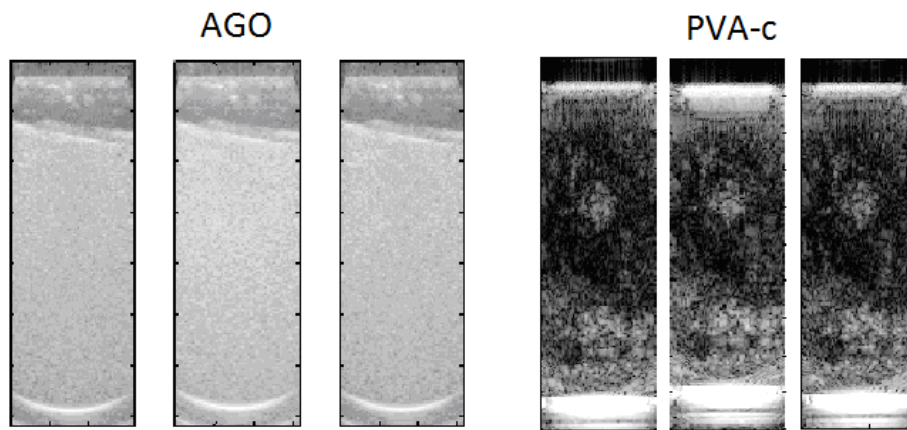

Fig. 1. B-mode image of AGO left, and PVA-c right, at different temperature levels, from left to right: image 1 at the beginning of experiment - 20.6°C, image 2 after 1 hour of heating, the temperature - 48.8°C, and image 3 the end of the experiment (after 2 hours of cooling) - 25.8°C.

Taking into account the fact that during a temperature increase some microstructural changes must take place and we demonstrate how the changes of the temperature level may be measured by changes in the correctly chosen statistical characteristics of the signal envelope. To analyze the temperature dependence of scattered envelope statistics we register the thermal process in two different heating experiments by using two different tissue mimicking materials, made in IPPT. Chapter 1 contains a description of these experiments, as well as received row RF signal processing in order to be able to carry out statistical analysis, and this is described in Chapter 2. Then in Chapter 3 a statistical analysis is performed. Some conclusions pertaining to how statistical analysis can be used in temperature measurement are stated in Chapter 4.

1. EXPERIMENTS

Two different experiments concerning the heating two phantom samples have been performed. The microstructures of AGO and PVA-c phantoms are seen on Fig.2. The source of heat was a focused beam ultrasound produced by a spherical transducer and a heated water bath for the AGO and PVA-c phantoms, respectively. The composition and production of the AGO (an oil -in- water mixture with 2% agar) was documented in our previous paper [4]. The PVA-c is prepared as a 10% water solution of PVA with one cycle of freezing.

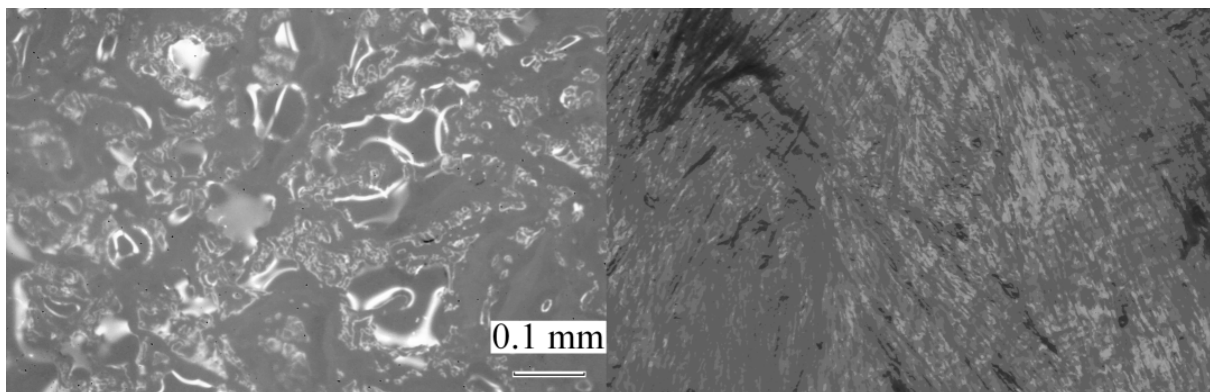

Fig. 2. AGO (left) and PVA-c (right) material microstructure, picture size of 600 x 900mkm; optical microscope (Nikon Microphot) image taken with a Nikon BD plan 5x/0.1 lens, pictures courtesy of Dr. W. Secomski.

The system for heating the AGO sample consists of a generator (Agilent 332, Aprings Colorado, USA), an amplifier (ENI 1325LA, Rochester NY, USA), a spherical ultrasonic transducer (central frequency 2.2 MHz, diameter 44mm, 44.5mm focal length, area $S = 15.2\text{cm}^2$) and an oscilloscope (Tektronix TDS3012B). Irradiation has 3 different powers: those of a 4, 6 and 8 W power have been performed. During 10 minutes of heating and 10 minutes of cooling temperature changes were recorded using thermocouples and registered by the USB module -TEMP. The temperature within the sample was measured along the beam axis at varying distances from the head. Geometrical focus was located c/a 44.5mm from the surface of the transducer, while the maximum temperature observed in the pattern was at a distance of 40mm, so practically the same. The linear transducer (L14-5/38) located across the heating beam at a distance of 40mm from the transmitter was used to produce images during the heating by the focused transducer, see Fig. 3.

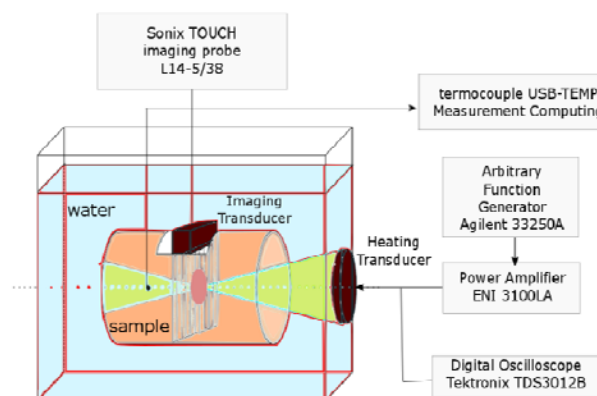

Fig. 3. Scheme of the AGO phantom heating experiment.

Synchronization in time of both ultrasound sources was carried out to ensure that the imaging process was free from noise coming from the heating beam. The employed ultrasound imaging system (Sonix TOUCH, ULTRASONIX, British Columbia, Canada) recorded images every 5sec during the 20mins of the process. The sampling rate (sampling frequency) was 40MHz and the imaging frequency was 8MHz. The shape of the image being scanned was a rectangle of 36mm x 16mm. Varying powers of the heating transducer were used: 4 W, 6 W and 8 W. In all cases the thermocouples' measurements have been provided, cf. Fig. 4.

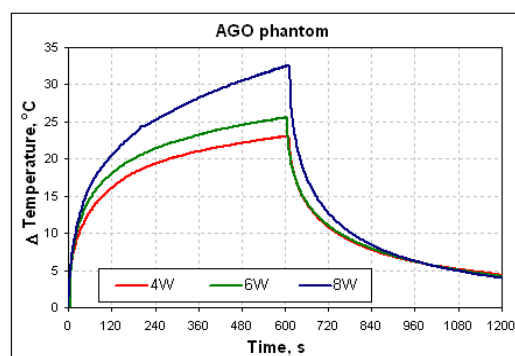

Fig. 4. The experimentally determined temperature changes at the point of focus (highest heating) in the AGO sample as a function of time/different values of power applied to the head, 10min heating and 10 min cooling.

The physical properties of the PVA-c sample have properties that prevent the production of heat at the time of ultrasound beam irradiation. Due to this, the PVA-c sample was heated in a water bath for 1 hour and cooled for 2 hours, see Fig.4.

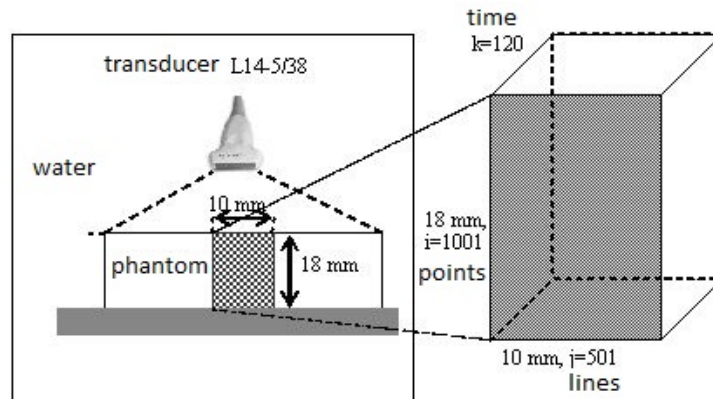

Fig. 5. Heating of the PVA-c phantom in a water bath; a schematic image of data acquisition.

The thermostat was set so that within one hour the temperature of the bath had increased linearly from 20.6°C to 48.8°C. Next, the heating was switched off and after 2 hours the temperature of the water reached 25.8°C. The measurements of RF signals were carried out by means of ultrasound (ULTRASONIX SonixTOUCH, British Columbia, Canada) with the head L14-5/38 being placed over the sample in the bath. Data was collected by ULTRASONIX L14-5/38 head, at a frequency of 8~MHz. The transmitted pulse comprises 2 periods of the sine wave pulse duration of 0.25 microseconds. At a time of 1 hour and 2 hours of heating/cooling, RF (Radio Frequency) signals were recorded every half a minute (361 times). The data RF signal has the form of an analytical signal (complex values), whose module gives the envelope of the RF signal as a matrix of 1001 x 501 x 361.

Because in this experiment we did not measure temperature inside the sample the temperature changes measured in the water are used to calculate the temperature inside the sample during process by Abaqus 6.12 software (DS Simulia Corp.) [6], see Fig. 5.

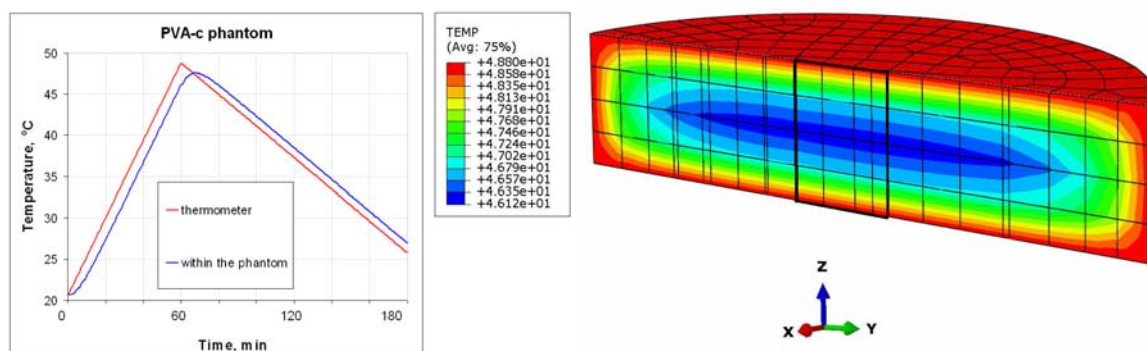

Fig. 6. Temperature as a function of time during the heating/cooling process for the PVA. Left - the plot of the calculated temperature after 1 hour of heating at different points in the sample, indicated on the right The black line isolates the area scanned by the ultrasound transducer.

2. SIGNAL PROCESSING AND STATISTICAL DISTRIBUTION

For all calculations carried out on RF signals during the heating/cooling processes, we use MATLAB (The MathWorks, Inc., Natick, Massachusetts, USA) version R2014a, with Signal Processing Toolbox and Statistics Toolbox.

Before performing a statistical analysis, the initial data set was modified by the following steps. Firstly, an experiment data array of a size of 1001 x 501 x 361 was reduced to an array of 601 x 501 x 361, by removing 200 points from each side. Secondly, zero-phase digital filtering with the Butterworth filter was performed. Additionally, a filter, which reduces the tendency of changes in depth so the special compensation of attenuation could be carried out, and finally the envelope was calculated. In order to have a high enough number of values in the statistical ensemble, the all lines for one image at a fixed time point were considered simultaneously. They form the ansamble for the statistical analysis.

Several probability distribution functions (PDF) were used to look for proper temperature "tags". In particular, two of them are finitely used in the next chapter, namely Rayleigh distribution and K- distribution. Their PDF's have the following forms [7].

Rayleigh distribution is defined by

$$P_{Ra}(A|\sigma^2) = \frac{A}{\sigma^2} \exp\left(-\frac{A^2}{2\sigma^2}\right),$$

where A represents the amplitude of the signal.

K-distribution is defined by

$$P_K(A|\sigma^2, \alpha) = \frac{4A^\alpha}{(2\sigma^2)^{(\alpha+1)/2} \Gamma(\alpha)} K_{\alpha-1}\left(\sqrt{\frac{2}{\sigma^2}} A\right),$$

where $\alpha > 0$, $\sigma > 0$ is the shape and the scale parameter, respectively, Γ is the Euler gamma function, and K_p denotes the modified Bessel function of the second kind of order p .

Let us remember that the amplitude of the backscattered signal, from large number of small, the same scatterers being uniformly distributed in the resolution cell, is Rayleigh distributed. The amplitude of the signal scattered from the region, with infinitely many scatterers non-uniformly distributed in the region, is K-distributed. In a case in which scatterers are grouped, K- distribution, as a consequence, has an additional parameter which measures the degree of clusterization, called a shape parameter.

3. RESULTS OF STATISTICAL ANALYSIS

The 4 sets of data, 3 for the AGO sample (heated rapidly during 10 minutes and cooled for 10 minutes at 3 different powers), and 1 for the PVA-c sample (heated homogenously, slowly for 1 hour and cooled for 2 hours) were used in the statistical analysis. At first, density histograms are calculated and their similarities to the other estimated distributions are depicted in Figs.7, 8.

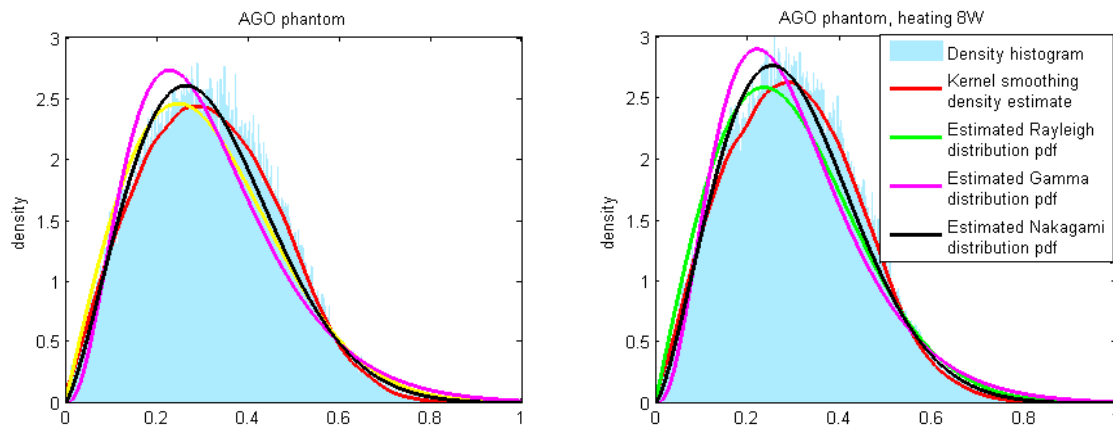

Fig. 7. Histogram designated for empirical data, registered for the AGO phantom before heating (left) and after heating – with 8W power - with probability density functions fitted.

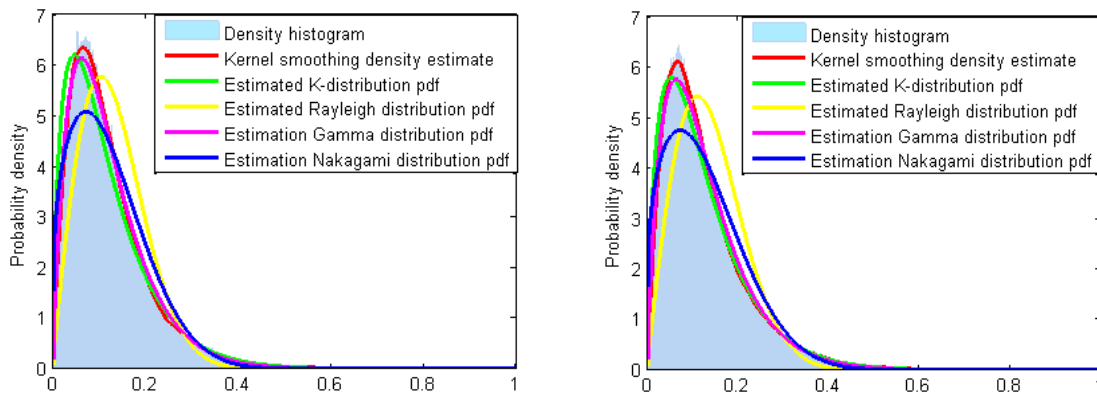

Fig. 8. Histogram designated for empirical data, registered with the PVA-c phantom without heating (left) and heating (right) and probability density functions designated fitted (K- distribution, Rayleigh, Gamma and Nakagami distribution).

In the case of the AGO sample the best fit to the histogram (the smallest mean square error) is Rayleigh distribution, which only has one parameter. To demonstrate that it can be used as a “tag” for temperature changes, we calculated its temperature dependence at the 3 different powers of heating, see Fig.9.

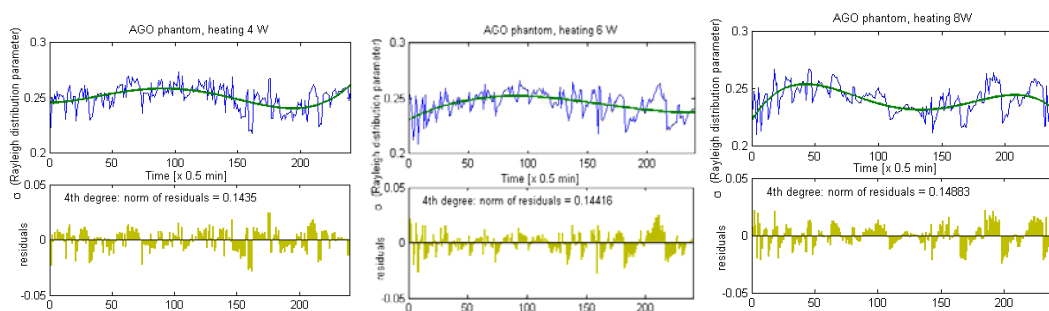

Fig. 9. The scale parameter of Rayleigh distribution as a function of time, together with its polynomial approximations calculated from data for the AGO sample.

In the case of the PVA-c sample, the best fit to the histogram (the smallest mean square error, see Tab.1), is K-distribution, which has two independent parameters. The choice of the shape parameter is justified by its interpretation as a measure of the “effective number of scatterers”, see [1], [4]. The shape parameter dependence on the heating process is illustrated in Fig. 10.

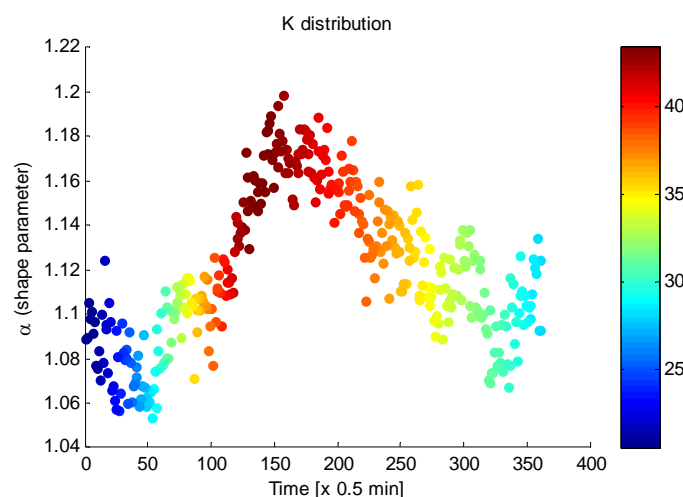

Fig. 10. Time/temperature dependence shape parameter, K distribution for the PVA-c phantom.

Tab. 1. Mean square error (MSE), determined by comparing the different distributions of the empirical data at different times during the experiment with a heating and cooling of the PVA-C phantom

Time, min	Rayleigh	Gamma	Nakagami	K- distribution
1	0.4027	0.0233	0.1714	0.1207
20	0.4887	0.0240	0.1791	0.1028
40	0.5188	0.0331	0.2165	0.0991
60	0.5150	0.0288	0.1914	0.0670
70	0.4622	0.0268	0.1785	0.0663
90	0.4223	0.0237	0.1625	0.0597
110	0.4366	0.0223	0.1657	0.0647
120	0.4483	0.0264	0.1668	0.0647
160	0.4438	0.0287	0.1899	0.1049
180	0.4433	0.0284	0.1859	0.0956

4. DISCUSSION AND CONCLUSIONS

Two different materials were used as samples of soft tissue phantoms. The AGO sample has a different microstructure than that of soft tissue, without the typical aggregates of small scatterers, which is connected with the K-distribution of the signal envelope. Therefore, we studied Rayleigh distribution scale parameter as a temperature “marker”. In Fig. 9 the temperature increase and decrease is well correlated with the increasing and decreasing of the smooth approximation of scale parameter changes. This also links well with the illustration of the rate of heating, slow for -4 W heating power, faster for 6 W, and the fastest for 8 W. They can be measured by the value of the derivatives of approximating polynomials. For temperature changes in the PVA-c sample, in which the microstructure has a multilevel

character, more close to tissue microstructures, the shape parameter of K-distribution is an excellent temperature marker, cf. Fig. 10. The links of the rate of heating and the rate of shape parameter changes are both visible. The result has been obtained for the process of slow, homogeneous heating (by a water bath). We have no experiments to compare the relations to other thermal processes. There is a real need for further research in order to find any links between temperature level, the microstructure of the material PVA-c and the values of the shape parameter. After such an evaluation of our results, the shape parameter could be used for the ultrasonic measurement of the microstructure, which makes it competitive with other methods currently used in physical chemistry.

ACKNOWLEDGMENT

This work was partially supported by the National Science Centre (grant no. 2011/03/B/ST7/03347).

REFERENCES

- [1] H. Piotrkowska, J. Litniewski, E. Szymańska, A. Nowicki, Ultrasonic Echosignal Applied to Human Skin Lesions Characterization, *ARCHIVES OF ACOUSTICS*, 37, 1, 103-108, 2012.
- [2] G. Thakur, M. A. Naqvi, D. Rousseau, K. Pal, A. Mitra, A. Basak, Gelatin-based emulsion gels for diffusion-controlled release applications, *Journal of Biomaterials, Science: Polymer Edition*, 23, 645-661, 2012.
- [3] M.-C. Ho, Y.-H Lee, Y.-M. Jeng, C.-N. Chen, K.-J. Chang, P.-H. Tsui, Relationship between Ultrasound Backscattered Statistics and the Concentration of Fatty Droplets in Livers: An Animal Study, *PLOS ONE* |www.plosone.org, May 2013, Volume 8, Issue 5, e63543
- [4] E. Kruglenko, B. Gambin, L. Cieřlik, Soft Tissue-Mimicking Materials With Various Number of Scatterers and Their Acoustical Characteristics, *Hydroacoustics*, 16, 121-128, 2013.
- [5] B. Gambin, O. Doubrovina, Statistical properties of wavelet transform coefficients of backscattering signal from soft tissues and their phantoms, *Hydroacoustics*, 16, 59-66, 2013.
- [6] B. Gambin, E. Kruglenko, T. Kujawska, M. Michajłow, Modeling of tissue in vivo heating induced by exposure to therapeutic ultrasound, *Acta Physica Polonica A*, 119, 950-956, 2011.
- [7] *Quantitative Ultrasound in Soft Tissues*, Ed. J. Mamou, M.L. Oelze, Springer 2013.