

AGEING OF CADMIUM TELLURIDE RADIATION DETECTORS AND ITS DIAGNOSTICS WITH LOW FREQUENCY NOISE

Alexey Andreev, Ondrej Sik, Lubomir Grmela, Josef Sikula

Brno University of Technology, Technická 8, 616 00 Brno, Czech Republic (✉ andreev@feec.vutbr.cz)

Abstract

Samples of CdTe single crystals which are used as radiation detectors were periodically measured during a long time interval with different values of an applied voltage. The samples were also periodically exposed during long time periods to high temperatures of 390 K and to rapid changes of temperature from 300 K to 390 K. After 1.5 years of measurements we observed ageing of the samples which resulted in deterioration of their transport characteristics. The resistance of the samples increased significantly and current-voltage characteristics were unstable in time. Noise spectroscopy showed that low frequency noise can be used for detection of CdTe sample ageing as its spectral density increases significantly comparing to the $1/f$ noise of a high quality sample.

Keywords: noise spectroscopy, CdTe radiation detectors, ageing process

© 2013 Polish Academy of Sciences. All rights reserved

1. Introduction

CdTe has been in the center of interest due to its applications in detection of hard X-ray and γ -ray radiation. It has also become useful as an electrooptical modulator, an optical material in the infrared and a solar cell whose maximum efficiency is as high as 23%. It is a material of great importance in the fields of both fundamental research and technical applications because of its structural, optical, electronic and photo-electronic properties. The main advantage of radiation detectors manufactured on a CdTe base is that they need no cooling and can operate at room temperature and there is more effective interaction of photons in CdTe than in either Si or Ge.

Physical properties of grown single crystals CdTe are dependent on the growing method and on burning technological processes. The main parameters of CdTe detectors are resistance (or conductivity), free carrier concentration, carrier mobility and their lifetime. For instance, specific resistance can be varied in the range $10^1 - 10^{10} \Omega \cdot \text{cm}$, free carrier concentration varies between 10^7 and 10^{16} cm^{-3} and their mobility can run up to $1000 \text{ cm}^2 \text{ V}^{-1} \text{ s}^{-1}$ for electrons and $100 \text{ cm}^2 \text{ V}^{-1} \text{ s}^{-1}$ for holes.

Despite an extensive effort in the last period, crystal quality remains a challenging issue [1]. The full potential of CdTe for high-energy photon detection applications was not exploited for many decades due to the limited commercial availability of high-quality crystals. One of the key problems is the presence of uncontrolled impurities, native defects and their precipitates which have deep energy levels. These levels act as recombination and trapping levels causing a decrease of charge collection efficiency [2-3]. Another factor that affects the reliability of devices based on CdTe single crystals is material ageing.

Material ageing is commonly understood as changes of material properties with time. In particular, materials are ageing due to many different causes; e.g. thermal treatment, thermal ageing, stress ageing, corrosion, irradiation embitterment, and others [3]. This paper shows

that ageing of CdTe crystals can be caused by long time periodical effect of temperature changes.

2. Reliability

Reliability physics is concerned with the study of the problems of reliability in all phases of manufacturing and during the life of electronic devices. One of the problems is the development of reliability prediction and selection methods or techniques of more reliable devices. It is known that the majority of failures in the flat region of the "bath-tub curve", the failure rate versus time, are the results of latent defects created during manufacturing processes or the operating life of electron device. The sensitivity of electron device noise to this kind of defect is the main reason for investigation and use of noise as a diagnostic and prediction tool in reliability physics.

The production of extra noise within a device will naturally reduce its quality with respect of its use in a low-noise system. Also such noise indicates nonideal processes which can degrade the device function. Experiments have shown on many systems that the noise level rises as a device degrades during its life, or under stress, and also that a device which immediately after manufacture shows high levels of noise has a short life and noise is thus a sensitive and non-destructive reliability indicator [4].

The essential features of the use of noise are that it is a nearly equilibrium measurement, so that no stress is given to the device, and that it is much more sensitive than DC or AC measurements. The latter are averaged quantities and the change in their values is usually found to be much smaller than that of the noise. Thus, during stress the DC and AC values may change by 1%, while the noise may increase by an order of magnitude.

Since it is found that the noise level increases at a much faster rate than the DC parameters as a device degrades under stress, or during its life, it can be used as a sensitive predictor of lifetime after a relatively short time. Thus a stress test to failure can be made with a simultaneous measurement of the noise. The initial rate of increase of the noise level can be related to the lifetime and this knowledge used over a short period of stress on fresh devices to predict their lifetime. Since only a short measurement time is needed for such a sensitive indicator this is almost nondestructive. If this analysis is performed at elevated stress and there is knowledge of the lifetime under normal conditions, then this initial measurement may give an estimate of the life in service.

The noise is a very sensitive but general measurement so that a calibration of its behavior must be made on each type of device which has a distinct design or manufacturing process. The extrapolation about the behavior may not be made between different fabrication regimes. Therefore one of our aims in future research is to perform calibration of CdTe noise properties so that noise could be used as a reliable indicator of quality and reliability of CdTe radiation detectors.

The main sources of noise in semiconductor devices are: $1/f$ noise, generation recombination noise with its component - RTS noise, shot and thermal noise. $1/f$ noise is dominant in the low frequency range [5]. Burst and $1/f$ noise has been considered a good way of detecting poor devices [6-8].

As a quality indicator we may choose the $1/f$ noise. One of the significant features of this noise is that it contains contributions from processes over a wide range of frequencies and appears to have the same properties at any time scale; it is scale invariant [9]. A possibility the noise measurements use in analysis, diagnostics and prediction of reliability of electronic devices was studied by many researchers.

The noise measurements can be used in connection with: (i) the estimation of the device reliability; (ii) the selection of reliable devices; (iii) the prediction of device failure; (iv)

control and screening in order to provide the expectable device quality and reliability during manufacture; (v) the diagnostics of defects and failures [10-12].

3. Sample description

Low-ohmic CdTe samples were manufactured by the Physical Institute of Charles University in Prague. CdTe single crystals were grown by the Bridgman method from Te-rich melt [13]. These samples are 11 mm long with a cross-section of 4.5 mm² and have four golden contacts: two current contacts and two voltage contacts, which are placed approximately 1.5 mm from current contacts to separate the contact areas from the homogenous crystal (Figure 1).



Fig. 1. CdTe single crystal sample.

The work function of an n-type CdTe is less than that of Au ($\phi_M = 5.37\text{eV}$, $\phi_S = 4.75\text{ eV}$). Therefore the excess positive charge appears in the CdTe within the depleted region. Similar processes are in p-type samples. For the studied CdTe detectors $\phi_M > \phi_S$ for an n-type CdTe and $\phi_M < \phi_S$ for a p-type CdTe, this leads to appearance of rectifying contacts at the metal-semiconductor junction [14]. All the studied detectors with p-type and n-type semiconductors have two rectifying contacts. Each metal – semiconductor contact is a Schottky diode. If there is no external voltage, each sample has two identical barriers at the metal-semiconductor junctions (Figure 2). In Figure 2 χ is the electron affinity, E_F is the Fermi level, E_C is the conductivity band, E_V is the valence band, E_D is the donor level position, eV_{bi} is the built-in potential without an applied electric field, L_d – is the depleted region width.

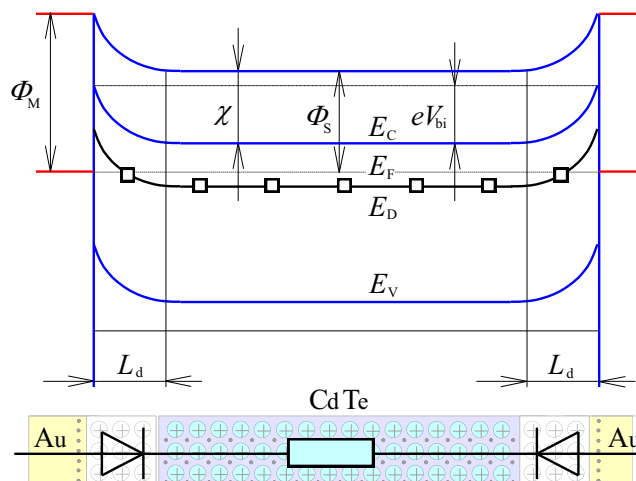

Fig. 2. The band diagram of an n-type CdTe sample. There are two rectifying contacts created by the metal-semiconductor junction.

For our analysis we can consider the studied CdTe sample with golden contacts as a series connection of two Schottky diodes with a resistor between them.

4. Experimental setup

The schematic diagram of the measuring setup intended for noise measurements is given in Fig. 3. The sample is fed from dry cells, which have low internal noise, negligible comparing with the background noise of the low-noise amplifier. The noise voltage is measured on the load resistor R_L . The capacitor C_f is a short circuit for an alternating signal, so the noise voltage on the load resistor is also the sample voltage for alternating signals. The battery, the sample, the capacitor, the load resistance and the preamplifier are placed in a cryostat, which serves to eliminate the electromagnetic field.

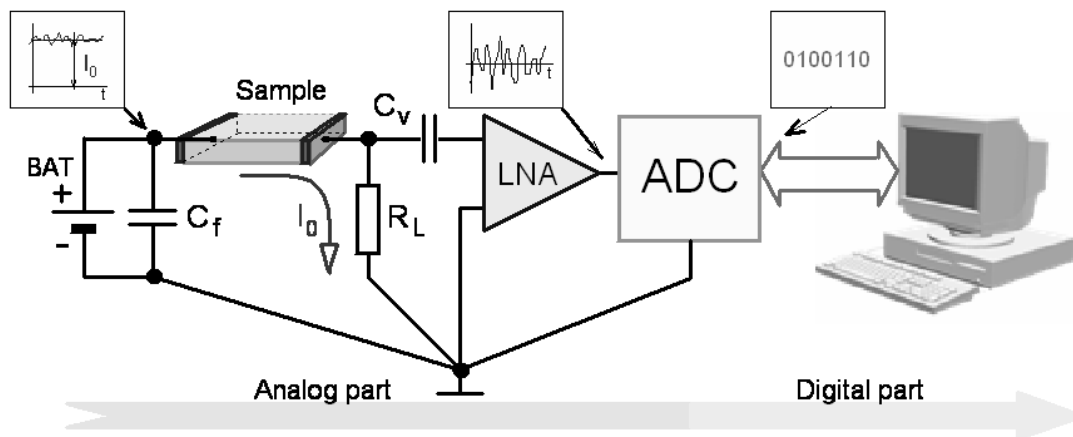

Fig. 3. Block diagram of the experimental setup.

The most important part of the noise measuring setup is the low-noise amplifier, which was designed in CNRL (Czech Noise Research Laboratory). It is a separately powered device, which is designed for universal amplifying and filtering of sampled signals from analyzed samples before further processing in analogue circuits or digitization [15].

The amplifier consists of an analogue and a digital part and accumulator supply. The analogue part accomplishes amplification and filtering of the input signal, the digital part allows to control the analogue part operation, communication through the GPIB bus and indication of working parameters on the display. The digital part also monitors the accumulator power supply.

The analogue part includes two amplifier sections, input with adjustable gain in the range 20 to 80 dB in 20 dB steps and output selectable amplification 1, 10 or 20 dB, selectable low pass filters (with adjustable cut-off frequency) and two or three sections of high-pass filters (adjustable cut-off frequency). One of the high-pass filters is inserted at the amplifier input, this one can be bypassed to reach optimal noise parameters at the low frequencies.

The selectable high pass filters can be adjusted in the range from 0.3 Hz to 300 kHz in decade series. Their steepness is either 12 or 18 dB/oct depending on the input coupling (insertion of the high pass filter at the amplifier input). The selectable low-pass filters cover the cut-off frequency range of 3 Hz to 300 kHz in decade series. They are designed as 5th order filters (30 dB/oct) to avoid aliasing during signal digitization.

The amplified signal is led to an A/D converter, which is a high performance, high speed, multi-function data acquisition card with a programmable gain and adjustable sampling frequency compatible with the PC. The card resolution is 12 bits and the conversion rate is up

to 1 MHz. The analog input signal ranges from ± 0.5 V to ± 10 V with the over-voltage up to ± 20 V.

5. Results and discussion

As it was mentioned above the studied CdTe samples have two metal-semiconductor junctions at current contacts. Therefore when an external electric field is applied, one of the junctions operates in forward bias and another one operates in reverse bias. The voltage drop must be significant in the reverse bias junction. The potential distribution of all the new CdTe radiation detectors was measured before the experiments. The results are similar for all the samples. Figure 4 illustrates a potential distribution diagram of CdTe samples measured at the beginning of the experiment. The applied voltage is 5.84 V. Almost the entire voltage drop in this case is concentrated in reverse bias and only 0.23 V in forward bias. The resistance of the bulk in this case is much smaller than the resistance of the metal-semiconductor junction.

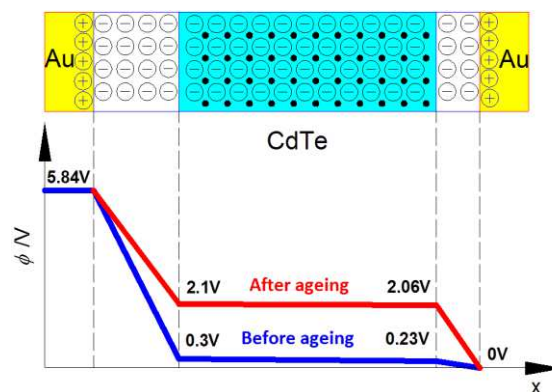

Fig. 4. The comparative potential distribution of CdTe sample before and after an ageing process.

At the beginning of the experiments before the ageing we also measured I-V characteristics of the samples so we could compare them with the I-V characteristics after the ageing process. All the samples showed consistent I-V characteristics with clear dependence on the temperature which did not change in time.

Noise characteristics of the samples before the ageing were also consistent with clear dependence on the temperature.

Relaxation processes in the bulk of the samples were studied with different temperatures during 1.5 years of research. The samples were periodically exposed to rapid temperature drops between 300 K and 390 K. During some experiments high temperature $T = 390$ K was kept for several days. Transport characteristics of the samples significantly deteriorated after 1.5 years of periodical measurements. As a result of ageing the voltage drop at the forward bias junction became significant and almost identical to the voltage drop at the reverse bias junction (Fig. 4, the upper line related to the measurement carried out after sample ageing). We believe that exposing samples to high temperatures during long-time measurements and rapid temperature changes caused ageing of the samples.

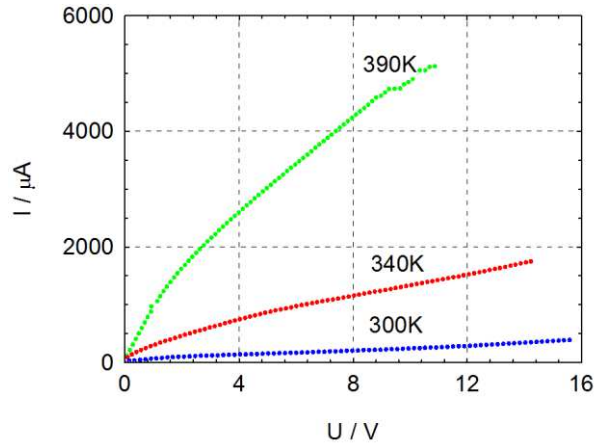

Fig. 5. I-V characteristics of a p-type CdTe sample before ageing.

Ageing also affected the I-V characteristics of the sample. Current-voltage characteristics of one of the samples measured before the ageing are in Fig. 5. There is clear dependence of the resistance on temperature; this dependence does not exist after ageing (Fig. 6). The conductivity of the samples decreases significantly especially at higher temperatures.

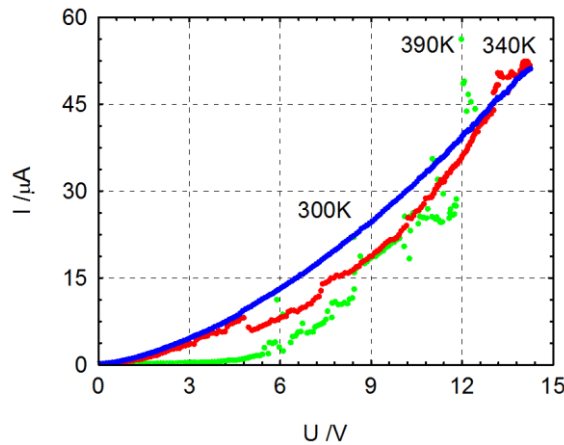

Fig. 6. I-V characteristics of a p-type CdTe sample after ageing.

I-V characteristics of the sample are very unstable in time after ageing (Fig.7, Fig. 8). Instability of I-V characteristics increases with higher temperature. Measuring at voltage contacts which separate bulk from contact areas shows that the homogeneous part of the sample remains stable with time and properties of the bulk do not change. What causes the deterioration of transport characteristics is the metal-semiconductor junction and this is the subject of our present deeper study.

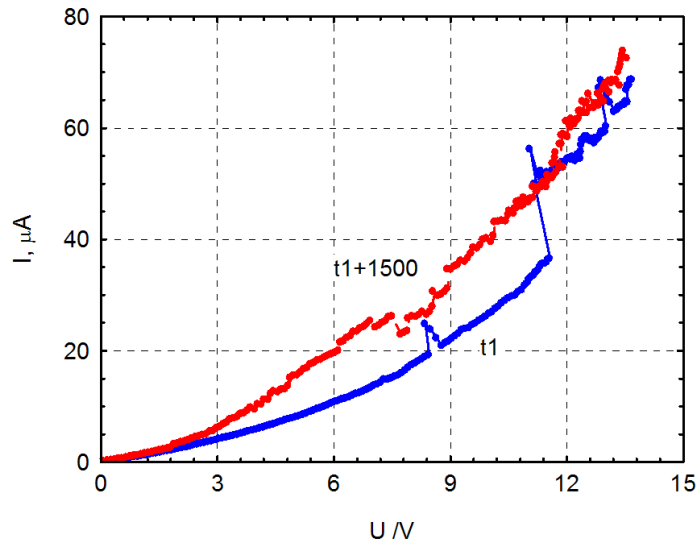

Fig. 7. I-V characteristics of a p-type CdTe sample after ageing. $T = 350$ K.

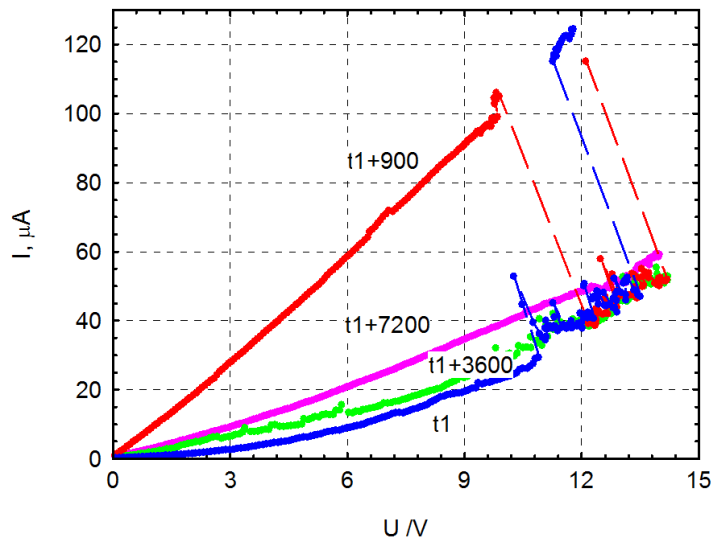

Fig. 8. I-V characteristics of a p-type CdTe sample after ageing. $T = 390$ K.

Transport characteristics of the identical samples which were manufactured at the same time and were not exposed to high temperature and rapid temperature changes during 1.5 years have stable I-V characteristics which do not change with time.

Noise characteristics of the samples exposed to the temperature changes also changed after ageing. Typical voltage noise spectral density of the samples with different values of applied voltage before the ageing process is shown in Fig. 9. Two types of noise can be seen from these measurements. In case of low applied voltage $U = 0.19$ V $1/f^n$ noise with the parameter $n = 1.37$ dominates almost throughout the whole frequency range and only starting at 10^5 Hz thermal noise can be observed. The value of thermal noise $S_U = 1.65 \cdot 10^{-17}$ V²s.

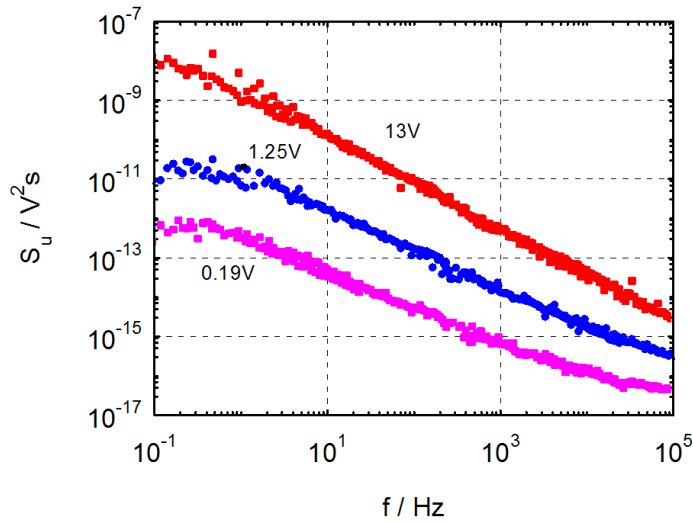

Fig. 9. Noise spectral density of CdTe sample before ageing.

At higher values of the applied voltage low-frequency noise dominates throughout the whole frequency interval. Parameter n of $1/f^n$ noise is very close to 1 for all the values of the applied voltage.

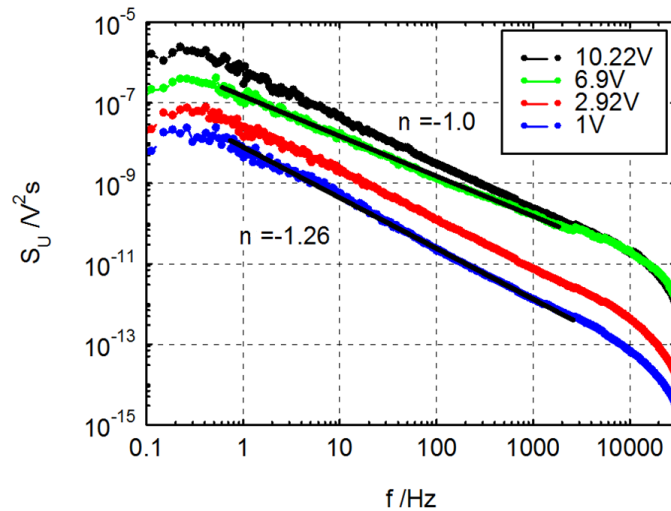

Fig. 10. Noise spectral density of CdTe sample after ageing.

Typical results of noise measurements of the samples after ageing are shown in Fig. 10. The dominant noise in this case is also $1/f^n$ with parameter n in the range $1.0 \leq n \leq 1.26$. The exact value of n is dictated by the nature of the recombination, the lifetime probability density function and also by the trap density function. It was shown that trap density functions with higher trap densities close to the conduction and valence band lead to higher values of n [16]. At this point of our study it is hard to define what exactly caused the increase of parameter n after ageing or how big was the contribution of each of the possible reasons. The most probable reason is increasing of trap densities as a result of ageing. This is the subject for further study.

Unlike the I-V characteristics, the noise characteristics remain stable in time. The values of voltage noise spectral density of the samples increases approximately by 3 orders of magnitude as a result of the ageing process. Comparison of noise characteristics of the

samples which were not exposed to the ageing process shows that voltage noise spectral density remains stable in time and it does not change.

6. Conclusion

A group of CdTe samples has been periodically exposed to high temperatures and temperature changes between 300 K and 390 K during 1.5 years of research. This deteriorated the transport properties of the metal-semiconductor junction of the samples. As a result of the sample ageing its I-V characteristics for particular temperature are not stable in time. Moreover there is no clear dependence of the resistance on temperature. Deterioration of transport properties of CdTe samples is more significant at high temperatures. At room temperature the instability of I-V characteristics is not obvious at each measurement and therefore many subsequent measurements are necessary to detect the process of ageing.

The effect of samples ageing can be effectively detected by using noise spectroscopy and $1/f$ noise can be used as a non-destructive method for CdTe samples quality indication. This is not surprising because the $1/f$ noise spectrum is a well-known tool for monitoring the reliability of electronic and ionic devices [17-20]. The value of voltage noise spectral density of aged samples is approximately by 3 orders of magnitude higher than that of high quality samples.

Acknowledgements

This research has been supported by the Grant Agency of Czech Republic No P102/10/P589 “Noise spectroscopy of CdTe X-ray and gamma-ray detectors” and by the Czech Ministry of Education in the frame of CZ.1.05/2.1.00/03.0072: Sensor, Information and Communication Systems.

References

- [1] Szeles C. (2003). CdZnTe and CdTe materials for X-ray and gamma ray detector applications. *Phys. Stat. Sol. (b)*, 241(3), 783-790.
- [2] Castaldini A., Cavallini A., Fraboni B., Fernandez P., Piqueras J. (1998). Deep energy levels in CdTe and CdZnTe. *J. Appl. Phys.*, 83, 2121-2126.
- [3] Takahashi T., Watanabe S. (2001) Recent Progress in CdTe and CdZnTe. *Detectors Nuclear Science*, 48, 950-959.
- [4] Jones B. K. (2002). Electrical noise as a reliability indicator in electronic devices and components. In *IEEE Proceeding of Circuit's Devices System*, 149(1), 13-22.
- [5] Sikula J., Stourac L. (2002). Noise spectroscopy of semiconductor materials and devices. In *23rd International Conference on Microelectronics*, 2, 767-772
- [6] Crook R., and Jones B.K. (1997). Noise and DC characteristics of power silicon diodes. *Microelectron. Reliab.*, 37, 1635-1638.
- [7] Koktavý B., Sikula J., Hruska P., Koktavý P. (1995). Burst noise in PN junction power diodes. IN *Proceedings of International NORDITO Workshop*, Brno, Czech Republic, 178-183.
- [8] Sikula J., Koktavý B., Vasina P., Chobola Z., Schauer P., Korenska M. (1994). Noise diagnostics of PN junction power devices. In *Proceedings of Fifth European Symposium on Reliability of electron devices, failure physics and analysis (ESREF 5)*, Glasgow, UK, 217-220.
- [9] Jones B.K. (1999). The scale invariance of $1/f$ noise. In *Proceedings of Unsolved problems of noise and fluctuations (UPON99)*, Adelaide, Australia, 115-123.

- [10] Redus R., Pantazis A., Huber A., Cross B. (2008). Characterization of CdTe Detectors for Quantitative X-ray Spectroscopy, *IEEE Trans. Nucl. Sci.*, 56(4), 2524-2532.
- [11] Jevtic M. M. (1995). Noise as a diagnostic and prediction tool in reliability physics. *Microelectronics and reliability*, 35, 455-477.
- [12] Stegemann D. H., Debarberis L., Acosta B., Beers M., Keinhorst G. (1999). Progress of the Ageing Material Evaluation and Studies by Non-Destructive Techniques AMES-NDT Concerted Action. In *The ninth international symposium on nondestructive characterization of materials*. Sydney, Australia, 263-268.
- [13] Franc J., Hoschl P., Belas E., Grill R., Hlidek P., Moravec P., Bok J. (1999). CdTe and CdZnTe crystals for room temperature gamma-ray detectors. *Nucl. Instr. Meth. A*, 434, 146-151.
- [14] Andreev A., Grmela L., Moravec P., Bosman G., Sikula J. (2010). Investigation of excess 1/f noise in CdTe single crystals. *Semicond. Sci. Technol.* 25(5), 1-7.
- [15] Grmela L., Majzner J., Pavelka J., Sikula J. (2002). Automatic noise spectral density measuring set-up. In *Proc. of Electronic Devices and Systems Conference*, Brno, Czech Republic, 114-120.
- [16] Mohammadi S., Pavlidis D. (2000). A Nonfundamental Theory of Low-Frequency Noise in Semiconductor Devices. *IEEE Transactions on Electron Devices*, 47(11), 2009-2017.
- [17] Smulko J., Azens A., Marsal R., Kish L., Green S., Granqvist C. (2008). Application of 1/f current noise for quality and age monitoring of electrochromic devices. *Solar Energy Mat. and Solar Cells*, 92(8), 914-918.
- [18] Chvatal M. (2008). Noise Reliability Indicators In SMT Chip Resistors. In *Proceedings Of The 14th Student EEICT 2008 Conference*. Brno, Czech Republic, 297-301.
- [19] Smulko J., Azens A., Kish L.B., and Granqvist, C.G. (2008). Low-Frequency Current Noise in Electrochromic Devices, *Smart Mater. Struct.*, 17(2), 1-4.
- [20] Smulko J. (2006). Methods of electrochemical noise analysis for investigation of corrosion processes. *Fluctuation and Noise Letters*, 6(02), R1-R9, DOI: 10.1142/S0219477506003252.