

Tomasz ŚLIWA<sup>1</sup>, Michał KORZEC<sup>1</sup>, Marek JASZCZUR<sup>2</sup>, Aneta SAPIŃSKA-ŚLIWA<sup>1</sup>,  
Artur GAJDOSZ<sup>1</sup>, Michał KRUSZEWSKI<sup>3</sup>

## A POSSIBLE APPLICATION OF ROTARY-PERCUSSION DRILLING METHOD IN SHALE GAS WELLS IN THE PODLASIE BASIN REGION

### ABSTRACT

The following work presents investigation of possible drilling of overburden rocks, right above the gas reservoir, in shale rock formations with potential application of rotary-percussion drilling method in Podlasie Basin region. Extensive description of lithology of shale rocks together with their age, maturity of the organic matter and thickness of particular layers have been presented. Due to different thickness of formations, the depths of layers are not indicated, as it would be too big of approximation. Various scaled and averaged thickness of particular formation layers was given in order to maintain maximum transparency of the paper. It should be noted that the formation rocks of the Devonian as well as Carboniferous period do not occur in all profiles of the Paleozoic period of the Podlasie Basin but only in the south-western part of the basin. Locally occurring (i.e. on the south-eastern border of the Podlasie basin) layers of the Devonian and Carboniferous period were omitted. A stratigraphic profile with preserved proportions between the average thicknesses of particular formation layers was constructed and presented in latter part of the research paper.

The research carried out in this paper was complemented with estimates of Polish shale gas resources. The Baltic Basin region is by far most prospective area for shale gas exploitation when it comes to documented as well as undocumented resources. The areas of Podlasie as well as Lublin Basins are second and third most rich areas of this resource.

Percussion-rotary drilling method enables for much higher penetration rates using similar weight on bit and rotational speed as in standard rotary drilling method. Following papers answers questions such as: under what conditions application of percussion-rotary technique is possible or what drilling fluids are the most suitable for such method. The percussion-rotary drilling method not only guarantees faster drilling but also leaves borehole much more straight and without unnecessary dog legs. Drilling rig and down hole equipment used for percussion-rotary

---

<sup>1</sup> AGH University of Science and Technology in Kraków, Faculty of Drilling, Oil and Gas, Poland.

<sup>2</sup> AGH University of Science and Technology in Kraków, Faculty of Energy and Fuels, Poland.

<sup>3</sup> International Geothermal Centre, Department of Advanced Drilling Technologies, Germany.

drilling method takes much less space in comparison with standard rotary rigs for deep drilling and could be potentially implemented for drilling shale gas wells in Podlasie Basin region.

## KEYWORDS

Shale gas, drilling technology, percussion drilling, Podlasie Basin

\* \* \*

## INTRODUCTION

Gas from shale rocks (also called shale gas) is, next to the compressed gas, methane from coal loads, gas in hydrates and the gas produced from reservoirs with abnormally high pressure and temperature values another type of unconventional hydrocarbons. In April 2011, the Energy Agency USA estimated shale gas resources in Poland, which amounted to 5.3 trillion m<sup>3</sup>, placing Poland on the 11<sup>th</sup> place in the world (first in Europe) when it comes to amounts of this resource. Bigger resources of shale gas can be found in China, USA and Argentina. In 2012, different estimates of amounts of this resource in Poland were made, based exclusively on boreholes from period between 1950 and 1990, resulting in 346 to 768 billion m<sup>3</sup> of shale gas (Polish Geological Institute 2012). Maximum resources were estimated to be 2 trillion m<sup>3</sup> ([www.lupkipolskie.pl](http://www.lupkipolskie.pl)). Figure 1 presents map of potential and already documented shale gas resources in Poland.

The mystery of natural gas in the Lower Paleozoic shales relies on common presence of graptolites i.e. small animals from Hemichordate phylum, which inhabited upper layers of seas and oceans from early Ordovician to early Devonian period. Their remains clustered in small bits on the bottom of seas for hundreds of millions of years. This organic matter later sank and together with weathered bits formed rocks, which then non-oxide, high pressure and temperature environment transformed them into shales. The organic particles gradually dissolved creating, among others, petroleum and natural gas.

The so called “shale belt” as seen in Figure 1, covers approximately 37 000 km<sup>2</sup> (around 12% of Polish territory) and spreads from northern parts of the country (i.e. Baltic Basin) through central regions (i.e. Podlasie Basin) to the east (i.e. Lublin Basin). All shale gas resources come from the Lower Silurian period (i.e. Llandovery, Wenlock and Lower Ludlow) or the Upper Ordovician (i.e. Caradoc and Ashgill).

In the major part of the Podlasie Basin, the Lower Silurian formations lie between depth of approximately 1500 and 4500 m below ground level with the deepest area in the eastern part of the Warszawa Basin and in the western part of the Podlasie Basin. The vitrinite reflectance of the Llandovery formations lies between 0.9–2% R<sub>o</sub>, with the reflectance for petroleum at 0.6–1.6% R<sub>o</sub> and 1.6–2.7% R<sub>o</sub> for natural gas according studies led by Polish Geological Institute (2012).

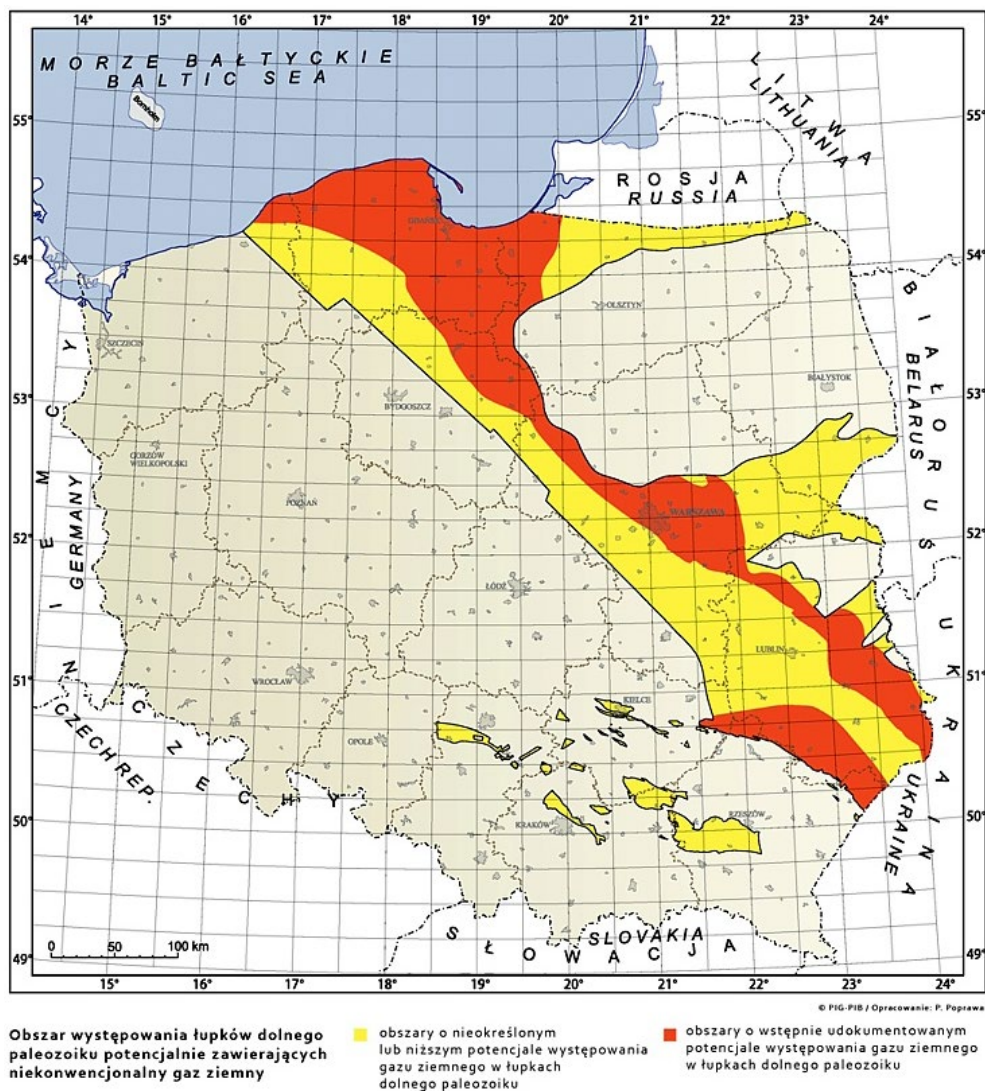

Fig. 1. Layout of geological basins in Poland (source: [www.shale-gas-information-platform.org](http://www.shale-gas-information-platform.org))

Rys. 1. Obszary występowania gazu łupkowego na terenie Polski (źródło: [www.shale-gas-information-platform.org](http://www.shale-gas-information-platform.org))

## 1. SHALE GAS RESOURCES IN POLAND

In Poland, most prospective shale gas reservoirs are located in the East European Platform (pre-Cambrian). Shale gas zones are limited by the Mid-Polish Anticlinorium from the west and the south. Parts which are located in the Podlasie Basin, containing potential shale

gas reservoirs, are Podlasie Subsidence and the eastern and the central part of the Warszawa Synclinorium. A characteristic feature of the Lower Paleozoic sediment profile in the Podlasie Basin (also in the Baltic and the Lublin Basins) is enriched with the organic matter shale, having the potential to accumulate hydrocarbons. In these layers, kerogen type II is prevalent. The reason for shale gas formation were tectonic processes controlling the development of the basin area. In the early stage of development of the Baltic-Podlasie-Lublin basin, bending of the plate with low supply of detritus enabled the creation of an accumulative zone and development of non-oxide environment near the bottom, which resulted in sedimentation of shale with rich organic matter.

In the Upper Silurian, supply of the detritic material stopped the sedimentation (Polish Geological Institute 2012). Sediment formations rich in the organic matter are shales of the Upper Ordovician, mainly the Caradoc, in the western part of the Podlasie Basin. The Upper Ordovician shales in the area of the Podlasie and Płock-Warszawa Basins are of 1.5 m to 52 m thickness.

The thickness of the Llandovery rock formations (Fig. 2A) rises, similarly to those from the Caradoc period, from east to west and generally ranges between 20 and 70 m. Wenlock formations (Fig. 2B), in the area of the Podlasie Basin, are characterized by a layer thickness less than 100 m (Fig. 2A). The depth of the shales from the Upper Ordovician and the Lower Silurian in the Podlasie Basin rises from east to west (Fig. 2C), from around 500 m in the east to 4000 m near the city of Warszawa (Polish Geological Institute 2012).

## 2. DATA FOR ANALYSIS

For the analysis of the potential application of the rotary-percussion drilling method for shale gas wells in the Podlasie Basin following boreholes were selected for analysis: Mszczonów IG1, Mszczonów IG2, Nadarzyn IG1, Okuniew IG1, Łochów IG1, Łochów IG2, Czyże IG1, Żebrak IG1, Tłuszcz IG1, Stadniki IG1, Wrotnów IG1 (Fig. 3). Wells located in the most prospective area are Nadarzyn IG1, Okuniew IG1, Łochów IG1, Łochów IG2, Żebrak IG1 and Tłuszcz IG1. From Okuniew IG1 well, located in Konstancin-Jeziorna city in Mazowieckie voivodeship, a sample was taken from the Llandovery formations in which a significant portion of highly transformed bitumen was found.

Thickness of the prospective shale gas layers is significantly varied for analyzed wells (i.e. the Upper Ordovician – the Caradoc, the Ashgill, a big part of the Silurian – the Llandovery, the Wenlock, the Lower Ludlow). Near the area of Nadarzyn, thickness of prospective layers was not measured. In Okuniew IG1 well thickness of prospective layer amounted to 261 m, whereas in Żebrak IG1 well to 176 m. Definitely, boreholes in Czyże area need to be rejected (the thickness of the Upper Ordovician is slightly over 18 m, no Silurian formations). Same applies to Stadniki area with thickness of around 140 m, however the rocks reside on a deep level, presumably too deep for the organic matter to transform correctly. Moreover, these are mainly rocks from the Lower Ludlow, which is less prospective than the Wenlock or the Llandovery. Well Łochów IG1 was also rejected, since there are no Silurian layers.

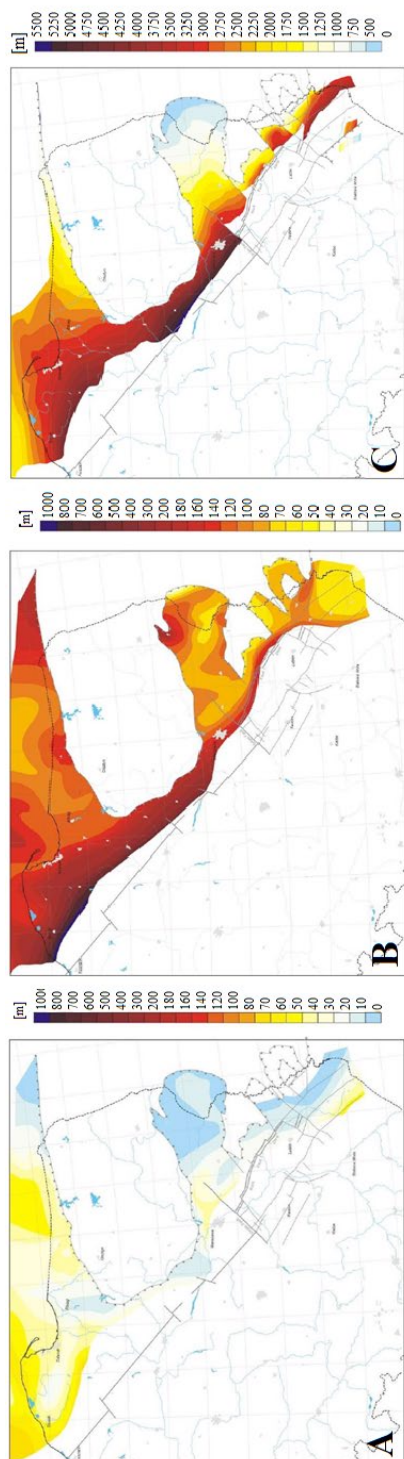

Fig. 2. A – thickness of the Llandovery (the Lower Silurian) formations in the Baltic-Podlasie-Lublin Basin; B – thickness of the Wenlock (the Lower Silurian) formations in the Baltic-Podlasie-Lublin Basin; C – depth of the Llandovery (the Lower Silurian) formations in the Baltic-Podlasie-Lublin Basin (Polish Geological Institute 2012)

Rys. 2. A – miąższość formacji Llandovery (sylur dolny) w basenie bałtycko-podlasko-lublińskim; B – miąższość formacji Wenlock (sylur dolny) w basenie bałtycko-podlasko-lublińskim; C – głębokość zalegania formacji Llandovery (sylur dolny) w basenie bałtycko-podlasko-lublińskim (Polski Instytut Geologiczny 2012)

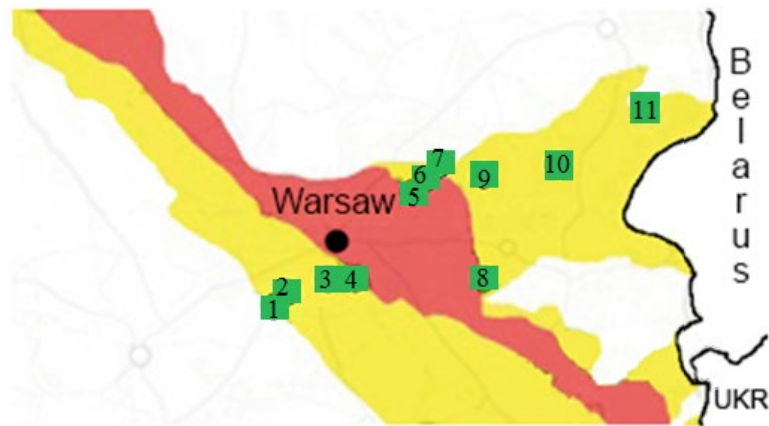

Fig. 3. The Podlasie Basin with location of analysed boreholes; orange – areas with documented presence of shale gas; yellow – areas of potential presence of shale gas of the Lower Paleozoic (1 – Mszczonów IG2, 2 – Mszczonów IG1, 3 – Nadarzyn IG1, 4 – Okuniew IG1, 5 – Tuszcz IG1, 6 – Łochów IG1, 7 – Łochów IG2, 8 – Żebrak IG1 9 – Wrotnów IG1, 10 – Stadniki IG1, 11 – Czyże IG1) (source: geoportal.pgi.gov.pl)

Rys. 3. Obszar basenu podlaskiego wraz z lokalizacją analizowanych otworów; pomarańczowy – obszar o udokumentowanych złożach gazu łupkowego; żółty – obszary o potencjalnym występowaniu gazu łupkowego w formacjach dolnego paleozoiku (1 – Mszczonów IG2, 2 – Mszczonów IG1, 3 – Nadarzyn IG1, 4 – Okuniew IG1, 5 – Tuszcz IG1, 6 – Łochów IG1, 7 – Łochów IG2, 8 – Żebrak IG1 9 – Wrotnów IG1, 10 – Stadniki IG1, 11 – Czyże IG1) (źródło: geoportal.pgi.gov.pl)

The depth at which the Llandovery formations have their bottom are very diverse. From 1126.3 m in Stadniki IG1 well (however it needs to be noted that this is a supposed border, because the origin of rocks coming from this borehole at mentioned depth is rather uncertain; probably they are of the Llandovery group), through 1885 m in Łochów IG1 well, 1963.8 m in Tuszcz IG1 well (Jadów, Mazowieckie Voivodeship), 2358.2 m in Żebrak IG1 well (Żebrak, Mazowieckie Voivodeship), 3568 m in Okuniew IG1 well and probably 4500–5000 m in Nadarzyn IG1 well (the borehole does not intersect the Lower Silurian).

### 3. EXEMPLARY BOREHOLE SPECIFICATION

A brief description of exemplary well Okuniew IG1 which was drilled through gas bearing shale rock formations is presented below.

#### 3.1. Borehole's characteristic

Technical specification of Okuniew IG1 well is given in table 1.

Drilling operations were carried out using a rotary core barrel (Uralmasz-3D). Casing program of Okuniew IG1 well is presented in Table 2, whereas results from coring operations in the same well are presented in Table 3.

Table 1

*Technical specification of Okuniew IG1 well (Areń 1975)*

Tabela 1

*Specyfikacja techniczna otworu Okuniew IG1 (Areń 1975)*

Location	Konstancin-Jeziorna (Mazowieckie voivodeship)	
Geographical coordinates	Longitude: 21o 17' 46,21"	Latitude: 52o 16' 19,58"
Drilling commenced	16.09.1965	
Drilling finished	11.10.1967	
Final depth	4298 m	
Elevation	100 m	

Table 2

*Casing program of Okuniew IG1 well (Areń 1975)*

Tabela 2

*Orurowanie otworu Okuniew IG1 (Areń 1975)*

Top of casing string [m]	Casing shoe depth [m]	Casing string diameter [inches]
0	6	4
0	65	18 5/8
0	716	13 3/8
0	2448	9 5/8
1893	3634	6 5/8

Table 3

*Core recovery from Okuniew IG1 well (Areń 1975)*

Tabela 3

*Odzysk rdzenia w otworze Okuniew IG1 (Areń 1975)*

Top of coring [m]	Bottom of coring [m]	Interval thickness [m]	Core recovery [%]
0	922	922	0
922	2075	1153	11
2075	2260	185	21
2260	3568	1308	10
3568	4240	672	45
4240	4298	58	41

### 3.2. Lithological description

In upper parts of the borehole, one may observe the Quaternary rock formations. Up to 30 m below ground level, formation rocks are mainly light fine and medium grained sands. In the next 8 m, formation rocks are colored crystalline and limy or flint stone gravels. At this depth, bottom of the Quaternary and the top of the Pliocene periods are found. In the Pliocene, between 38 and 67 m formations are colored sandy claystones, where bottom of which is simultaneously the bottom of the Pliocene epoch. Between 67 and 194 m of depth, Miocene formation rocks are present. From the Miocene ceiling to 140 m, fine and medium grained sands and clayey shale are found. The next 20 m is taken by lignite formations with silt and sand inserts. To 174 m, sands without lignite are present, whereas from that point onwards, silts and grey claystone. A 43 meter deep Oligocene layer is distinct after 194 m. To 206 m, grey quartz gravel and green sands with glauconite are present. Below, one may find sands with quartzite gravel and sands with glauconite. The thickness of this complex reaches 237 m. To 268 m, Paleocene formation layers consisting of silty sediments (to 247 m) and marls with limestone overgrowth (247–268 m) are present. In deeper sections, ceiling of the Cretaceous is present. In the Maastrichtian (between 268 and 430 m), layers are composed mainly from white marly chalk. The interval between 430 and 560 m consists of the Campanian rocks, which geologically are the same rocks as in the Maastrichtian period, however might include marl inserts. The Santonian (depth between 560 and 736 m) formations are composed mainly from white marly chalk with bits of flint stone (to 663 m) and white marly limestone to the bottom of the Santonian. The formation rocks from the Coniacian (to 772 m), the Turonian (between 772 and 863 m), the Cenomanian (between 863 and 884 m), and the Albian (to 886 m) are mainly sandstones. The Lower Hauterivian – the Upper Valanginian (898–912 m) rocks include mudstones (to 901.5 m), sandstones (between 901.5 and 903.5 m), claystones and mudstones (between 903.5 and 904.5 m), mudstones and sandstones with carbonate-sideritic overgrowth (to 912 m).

The Jurassic period is visible in the lower part of the profile. The Kimmeridgian period (from 922 to 952 m) is marly and grained limestone (to 925.3 m) and dark-grey marl, secondarily limestone (to 952 m). The Oxfordian formations (952–1293 m) consist of many types of limestones i.e. from pelitic, through oolitic and grained to 1180 m to spongiolitic limestone (to 1293 m). In deeper well sections, three meter thick layer of the Callovian is present, which consists mainly of white marly limestone with mixture of flint stone bits and rusty sandy limestone. The ceiling of the Bathonian is located at 1296 m, and ends at 1324 m. The Bathonian period consists of limestone and sandy dolomites. The Dogger rocks are located between 1324 and 1349 m (light-grey sandstone, loose claystone and mudstone). The Toarcian (between 1349 and 1419.7 m) includes brittle fine grained sandstones and sands (to 1387 m) and a ten meter thick layer of a concise clayey-silty packet, below claystones, clayey-sandy silts, sandstones as well as mudstones (of varied thickness) are present. The interval between 1419.7 and 1424.8 m contains transitional layer of the Lower Toarcian – the Domerian, which consists of claystone. The Domerian period (from 1424.8 to 1472.5 m) contains a sandstone



complex with scarce silty-clayey inserts. The Hetang formations (between 1472.5 and 1505 m) is composed with clayey-silty (to 1494.5 m) and a sandstone complex (to 1505 m).

The Triassic period (between 1505 and 2076 m) was not divided into levels. In the upper part, silty and clayey rocks are prevalent, however, sandstone and dolomite inserts are also present. From 1777.8 m, limestone becomes prevalent. Claystone occurs rather often, whereas mudstone is much more rare. From depth of 1837.2 m limestones are less common, whereas claystone and mudstone are becoming much more visible. From 1987.1 m claystone begin to be dominant, which sometimes transfer into clayey shale. From 2031.5 m to the end of the Triassic profile sandstones and mudstones are again much more frequent. Mudstone is the main formation of the Triassic period from depth of 2063.5 m. The Permian (between 2076 and 2279 m) is divided into the Upper Permian (to 2264.5 m) and the Lower Permian. To depth of 2091.5 m almost only anhydrites are present. In sections below, one may find marly, silty and clayey dolomites (to 2107.6 m). Anhydrite is the main rock of the whole Upper Permian. Rock salt is also present in profiles of this period. In the Lower Permian, apart from anhydrites, one may also observe clayey-limy shale, limestone and dolomites. The Silurian (from 2279 to 3568 m) period was divided into different sections. The Upper Ludlow (3279–3352 m), i.e. Siedlce layers, is characterized mainly by pelitic grey-greenish claystone; lower grey and dark-grey, and laminated only in the lower parts. Mudstones are also present in this section. The Lower Ludlow (3352–3440 m), i.e. Mielnik layers, is composed of laminated dark-grey limy claystone. Fauna of the Ludlow is rich in graptolites. The Upper Wenlock (3440–3495 m) is represented by dark-grey limy, shale and laminated claystone with numerous graptolites. The Lower Wenlock (to 3522 m) is mainly dark-grey, locally black, shale claystone with scarce clusters of pyrite and rich in fauna. In the Upper Llandovery (3522–3526 m), the dominant sediment is grey-green claystone, sometimes grey, limy-dolomitic, non-fissile with inter-layers of black shale. The lowest level (3561.6–3563.6 m) consists of claystone and black laminated heavily fissured shale with crystalline pyrite clusters. The Lower Llandovery (3563.6–3568 m) is claystone and black bitumen or tar shale. The Llandovery fauna is also rich in graptolites.

In the Ordovician, the Ashgill is characterized mainly by different types of marl (mainly dark-grey, but also silty-sandy), whereas the Caradoc is black claystone, dark-grey marl, marly limestone or, in the lower part, grey-green marl and grey limestones. The fauna of the upper levels in the Ordovician period is however very poor – graptolites are scarce and if they occur at all, they are in the residual form. Looking at the Silurian bitumens' volume, the sample from the Llandovery contains a small amount of greatly metamorphosed bitumens that differ in the character of absorption in infrared from the Caradoc micro-oil. The Wenlock series are characterized by a higher volume of organic carbon and bitumens, which are heavily metamorphosed. A significant amount of paraffine-naphtalene hydrocarbons and increased migration coefficient may indicate possible migration of bitumens. Taking into consideration that hydrocarbons are less aromatic, it was assumed that high volume of petroleum had migrated out of the sediments. Three Siedlce levels were found in the Ludlow formations. The Lower Siedlce layers are characterized by small amount of homogenous

organic matter (from 0.20 to 0.62%  $C_{org}$ ). Highly metamorphosed bitumens of a micro-petroleum nature occur from time to time. Given the low migration coefficient, one should not assume the presence of active migration processes in these sediments. The Mid Siedlce layers contain small amount of highly metamorphosed bitumens. The Upper Siedlce contain a slightly higher amount of bitumens that are semi or highly metamorphosed, having between 15 and 35% of hydrocarbons, which differ in the aromatics level (i.e. 27% of aromatics in hydrocarbons in a sample from 2322.8 m, 10% and 11% in two other samples). However, the migration coefficients are rather small. For the Silurian, the effective porosity was measured only in the Upper Ludlow – it amounts to 14% with 4% at lowest and 6% on average out of 25 measurements (Areń 1975).

#### 4. GEOLOGICAL CONDITIONS OF PODLASIE BASIN

Figures from 6 to 9 present geological profiles and cross sections of the Podlasie Basin. The lithological description of the Podlasie Basin has to begin with the youngest epoch, namely the Holocene according to Peryt and Piwocki (2004).



Fig. 4. Location of the cross-section from figure 5

Rys. 4. Lokalizacja przekroju poprzecznego z rysunku 5

##### 4.1. Quaternary

Thickness of river sediments from the Holocene is on average from 5 to 15 m (in the Wisła river valley). Further down the course, it may reach approximately 25 m, and locally even higher values might be observed. The general thickness of the Quaternary is between few and around 200 m. There is a low share of till, a major share of proglacial formations towards West (dusty clay, dust), and high amounts of xenoliths (from the Jurassic through the Pliocene) and glacitectonic formations in the northern part of the region.



Fig. 5. Geological cross-section along the axis of the Podlasie Depression (Ecm – Eocambrian, Cm – Cambrian, O – Ordovician, S – Silurian, P – Permian, T – Triassic, J – Jurassic, K – Cretaceous, crosses – Pre-Baikal ground, black – Vendian basalt and veins of Paleozoic vulcanites) (Pożaryski 1974)

Rys. 5. Geologiczny przekrój poprzeczny basenu podlaskiego (Ecm – eokamr, Cm – kambr, O – ordowik, S – sylur, P – perm, T – trias, J – jura, K – kreda, krzyżyki – warstwa przed formacją jeziora Bajkał, czarny obszar – bazyły wendu oraz żyły paleozoiku) (Pożaryski 1974)

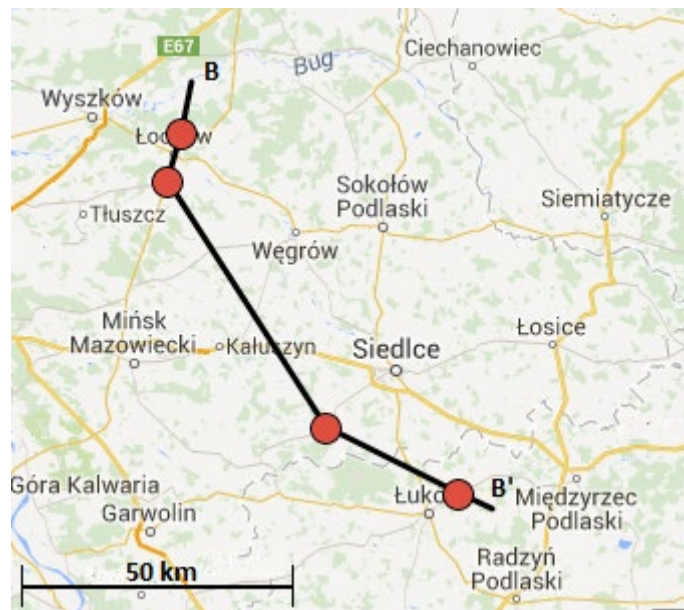

Fig. 6. Location of the cross-section from figure 7

Rys. 6. Lokalizacja przekroju poprzecznego z rysunku 7

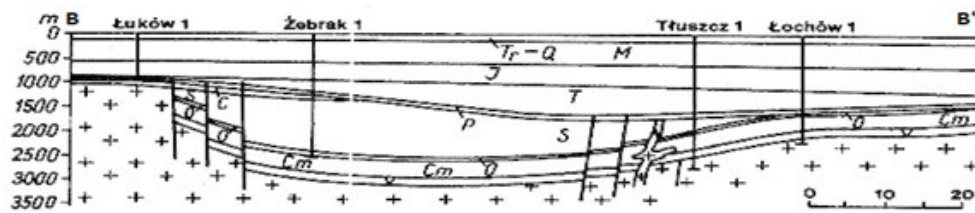

Fig. 7. Geological cross-section of the Podlasie Depression (Cm – Cambrian, O – Ordovician, S – Silurian, P – Permian, T – Triassic, J – Jurassic, M – Mesozoic sediments (mainly Cretaceous), Tr – Q – Tertiary and Quaternary, crosses – Vendian basalt and veins of Paleozoic volcanics) (Stupnicka 1997)

Rys. 7. Geologiczny przekrój poprzeczny Basenu Podlaskiego (Cm – kambry, O – ordowik, S – sylur, P – perm, T – trias, J – jura, M – sedimenty mezozoiku, Tr – Q – trzeciorząd oraz czwartorzęd, czarne krzyżyki – bazalty wendy oraz żyły paleozoiku) (Stupnicka 1997)

## 4.2. Neogene

Neogene is the younger period of the Cenozoic era that lasted from 23.03 to 2.58 million years ago.

### 4.2.1. Pliocene

In the Mazowsze Lowland and the surrounding uplands area, sandy-gravel river series residing immediately on Poznań claystone are commonly found. Formations periglacial in this area reach 54 m at most, and from 5 to 15 m on average. These are non-uniform sands, locally with a mixture of gravels and inserts of silts and loam. Gravels, mainly fine, comprise of approximately 10% (locally reach even 60%). In Magnuszewo and Łękawica series, periglacial formations are up to 27.1 m thick.

### 4.2.2. Miocene

The Miocene sediments are commonly present in the described Podlasie Basin (Sokołowski 1984). Their thickness is similar or identical to the sediments of the whole Neogene complex. In Warszawa Basin, the Neogene sediments are characterized by an average thickness of 161 m, and maximum thickness of 200 m. Such high values of layer thickness may be of apparent nature resulting from different glaciectonic disturbances. Weathered covers in the Polish Lowland are partially from the Neogene and their thickness normally does not exceed 2–5 m.

## 4.3. Paleogene

Paleogene is the older period of the Cenozoic era. It lasted from 66.0 to 23.03 million years ago.

#### 4.3.1. Oligocene

In the Polish Lowland, the current thickness of the Oligocene formations is varied i.e. from a few to over 100 m (on average 50 m). The Oligocene outcrops covered by younger formations spread from Zielona Góra, northward from Wrocław-Łódź section and farther eastward to the country borders. The Oligocene consists of the informal Rupelian formation (silty-clayey lithofacies) and the Upper Mosina formation (sandy lithofacies with glauconite with 23.5 m thickness on average) and land and brackish formations from the Czempień area (silty-sandy lithofacies, often coal bearing). Towards East and South-East, the Rupelian sediments mesh with formations from the Czempień and the Upper Mosina. In Warszawa Basin, the Lower Mosina formation is represented non-limy quartz-glauconitic sands with quartz and lyditic gravel and small phosphorites. Its thickness amounts to 30 m at most and it is 10–20 m thick on average. The Czempień formation is from a few meters to over 50 m thick (23 m on average). At the point of meshing with the Rupelian formation, it amounts up to 6–9 m.

#### 4.3.2. Eocene

The Eocene sediments in the Polish Lowland are uncovered only in few places in Warszawa Basin and in the Podlasie Depression. The average thickness in the Polish Lowland amounts to 20 m for the Eocene and varies greatly from 1.4 up to 122.3 m. In the described area, the Pomorze formation is present near area of Warszawa. The thickness of these sediments is generally 18 m (from 1 to 80 m). In the lower part (the Lower Pomorze link) mainly quartz-glauconitic sands, with a fine layer of non-uniform clayed green sands with gravel are present. The Mid Pomorze link is represented by claystone with mudstone and sandy interlayers, whereas the Upper Pomorze link is made of silty-sandy formations. The Siemień formation (4 m thick on average) is another Cenozoic formation located in the shale belt. In the Podlasie-Lublin upland, they are over 15 m thick and consist of grey-green quartz-glauconitic sands with smooth phosphorites and scarce quartz gravel in the lower part. Sands become clayey towards the upper part and transform into dark-grey and green silty-sandy loam. In deeper sections dusty and fine grained quartz-glauconitic sands are located. The upper section is made of fine grained limy sands, transforming towards the ceiling into sandstone, mudstone or sandy claystone that underwent slight diagenesis. The ceiling contains clayey silt, clayey sandy spongiolites, and dusty or clayey sands. In Warszawa Basin (approximately 24 m), the Siemień formation is characterized by slightly limy quartz-glauconitic sands with gravel and phosphorites on the bottom, changing upwards into grey-green sandstone, claystone and sandy mudstone with fauna.

### 4.3.3. *Paleocene*

In the south-west of Warszawa Basin, the Lower Paleocene sediments are a complex of grey and grey-brown dusty and fine grained sands. An average thickness of the formation rocks from the Paleocene period for the Podlasie Basin and Warszawa Synclinorium areas amounts to 27 m.

## 4.4. **Cretaceous**

The Cretaceous was the last period of the Mesozoic era, which lasted for around 80 million years (from around 145 to 66 million years ago). The Cretaceous is divided into two chronostratigraphic series i.e. Upper Cretaceous and Lower Cretaceous.

### 4.4.1. *Upper Cretaceous*

In Warszawa Basin, in the Podlasie Depression between the Maastrichtian and the Paleocene, Upper Cretaceous it is quite visible. The Upper Cretaceous sediments in the Podlasie Depression are characterized by carbonate facies i.e. mainly chalk and limestone. The Upper Cretaceous in the northern part of the described area is covered with the Cenozoic sediments. On the Maastrichtian gaizes, in the near-bottom part of the Paleocene, sands and glauconitic sandstones with phosphorites and remnants of the Maastrichtian fauna in a derivative reservoir or sandy spongiolites rich in glauconite are to be found. The Sochaczew formation in Warszawa Basin reaches thickness approximately 6 m. In the lower part, mainly green sands or glauconitic sandstones with a phosphorite layer are located. Sandy spongiolites with limestone inserts may be found higher. The Puławy formation is 30 m thick. In Warszawa Basin and in the Podlasie Depression, the Puławy formation is made of marly or limy sandy spongiolites, partially transforming into gaizes, with inserts of grey limestone. In the Podlasie Basin, the Lower Cretaceous formations are present only in Warszawa Synclinorium, whereas the Podlasie Depression includes only a small part of the Lower Cretaceous at the border with Warszawa Synclinorium (Sokołowski 1973). The Upper Cretaceous of Warszawa Synclinorium is covered with the Lower Paleocene layers, consisting of glauconitic marly sandstones and sands, as well as sandy limestone (Sokołowski 1973). Below, there is the Upper Maastrichtian layer, which consist of marls containing flint stones, gaizes and secondary limestone. In the South (Ostrów Mazowiecka), sandy limestones with glauconite and chalk are present. These sediments are located between 0 and 170 m of depth. The thickness of the formation amounts from 40 to 60 m. The Lower Maastrichtian formations are located below, which include marls with flint stones and concise gaizes of 25–50 m. The Campanian is represented by chalk with flint stones (41–105 m). The Santonian is made of white chalk with flint stones (20–90 m). The Coniacian is represented by white chalk limestones with flint stones and chalk with flint

stones (4–52 m) and marly gaize and sandy spongiolites that are 7–30 m thick. The Turonian sediments are mainly sandy limestone and, in the upper part, white chalk limestone with flint stones and marly limestone with cherts and flint stones (40–162 m). Characteristic rocks of the Cenomanian are marly limestones, sometimes sandy with glauconite and phosphorites with thickness between 3 and 15 m. The transitional zone between the Upper Cretaceous and the Lower Cretaceous consists of glauconitic marly sandstones with phosphorites, sandy marls and sands. The Upper Cretaceous sediments present in the Podlasie Depression is characterized by carbonate facies; mainly chalk and limestone. The Upper Cretaceous formations in the northern part of the described area are covered by the Cenozoic sediments. In the Quaternary sediments, there are scarce erratic blocks, made of chalk, being significant as a resource. In the Maastrichtian, marls and gaizes are in the lower part, together with sandy marls with glauconite and, in the South, sandy limestone with glauconite with chalk being also present. These sediments are from 0 to 170 m thick. The Campanian is represented by chalk with flint stones (20–90 m). The Coniacian is represented by chalk limestones with flint stones and chalk with flint stones (4–52 m). The Turonian sediments are mainly sandy limestones and in the upper part white chalk limestone with flint stones and limestones with fine layers of marls (40–162 m). In the Cenomanian, organodetrritic limestones are prevalent, locally containing singular phosphorite concretions. In the lower part of the Cenomanian, marly limestones with glauconite, detritic quartz and singular phosphorite concretions are to be found. The thickness of the Cenomanian sediments ranges from 1 to 15 m.

#### *4.4.2. Lower Cretaceous*

The Upper Albian formation is between 50 and 100 m thick. The youngest rocks of the Lower Cretaceous (Albian) are represented by sands and sandstones that are mid or fine grained with clayey-silty interlayers, especially in the ceiling (9–28 m). Above the sands, sands and sandstones that are mid or fine grained with quartz gravel and rich in glauconite (4–37 m) are located. The Upper Hauterivian rocks are in the lower part – fine and very fine grained sandstones with clayey-coal inserts of 8 to 43 m, whereas is higher part – mainly silty and fine grained sandstones. In both upper and lower parts, clayey-silty sediments of 4.5 to 26 m thickness are dominant. The Hauterivian rocks are in the lower part mudstones and claystones with gravel. The thickness is amounted to approximately 43 m. Below that depth, Valangian formation rocks are located. The Lower Valangian consists of claystone and mudstone with interlayers of sandstone and siderite inserts and is 8 m thick. In the Mid Valangian, fine grained sandstone is dominant, whereas in the lower and the upper part of the complex, the clayey-silty sediments are the most frequent. The Upper Valangian consists of several meter thick loads of claystones and mudstones with sandstone interlayers with sandy-sideritic inserts with calcite and ferruginous oolitic clusters. The Lower Cretaceous in the Podlasie Depression, as mentioned above, is located only in areas bordering with Warszawa Synclinorium. The Albian is formed by 0 to 53 m thick glauconitic sandstones and

sands with claystone inserts. In the ceiling, small concretions of phosphorites are present in glauconitic sandstones and are of 0.5 m thickness.

#### **4.5. Jurassic**

It was the second period of the Mesozoic era, which lasted from approximately 201 to 145 million years ago. It is divided into three chronostratigraphic subdivisions i.e. the Lower, the Mid and the Upper Jurassic.

##### *4.5.1. Upper Jurassic*

The highest thickness of the Upper Jurassic was found in the marginal basin. From the marginal basin towards the Mazury-Suwałki Uplift and the Podlasie-Lublin Horst, the thickness of Jurassic sediments is visibly decreasing. The Portland rocks are silty marls and marly mudstones. However, they are present only in the southern part of Warszawa Basin and are around 5 m thick. The Upper Kimmeridgian consists of marls and marly limestones, silty marls, mudstone, and numerous shell limestones. Below, there are rocks from the Lower Kimmeridgian i.e. marly and pelitic or organodetritic and detritic limestones, grained oolitic-oncolytic limestones with numerous mussels. The Upper Oxfordian rocks mainly consists of oolitic, oncolytic grained limestones, mixed types, pelitic and marly limestones. The Mid Oxfordian is represented by grained oolitic-oncolytic, detritic limestones with cherts. The oldest rocks from the Upper Jurassic are detritic spongiolitic unevenly dolomitized limestones.

##### *4.5.2. Mid Jurassic*

The bottom of the Mid Jurassic is lithologically varied. It may reside on grounds from the Pre-Cambrian as well as the Devonian, the Carboniferous, the Buntsandstein or the Lias. Formation rocks in the greater part of the Podlasie Basin are from the Upper Bathonian and the Upper Callovian. The Callovian sediments lying on the bottom conglomerate are mainly sandy limestones or light-grey or cream limy sandstones. Oolites are also often present. The thickness of this layer is from 0.2 to 1 m. Higher rocks from the nodular bed (nodular fine-crystalline limestones, slightly sandy, sometimes marly, concise, filled with oolites) are located. Organodetritic limestones are also present, dominating in the Podlasie-Lublin area. The thickness of organodetritic limestones ranges, depending on the formation, from 0.35 to 5 m. The Upper Bathonian sediments begin with a fine layer of a bottom conglomerate, whose content differs depending on the area. Lithologically, those are xenoliths and pebbles, sometimes sandy conglomerate. It sometimes happens that heavily sandy organodetritic limestones reside on a smooth, cut off surface of Paleozoic bed rocks, without a bottom conglomerate. Above the conglomerate, a clayey-sandy or clayey-silty packet, which is 3–11 m thick is located. In places where the clayey-sandy packet is absent, organodetritic limestones



lie on the bottom. The thickness of these limestones may amount from 1 to 4 m. The ceiling of the clayey-sandy complex is represented by a conglomerate layer, covered with sandy organodetritic limestones, which are locally dolomitic. The thickness of the Upper Bathonian sediments ranges from 4.5 to 45 m.

#### *4.5.3. Lower Jurassic*

Near Warszawa area, the thickness of the Lower Jurassic is estimated at the level from approximately 100 to 300 m. Most of the Lias (Lower Jurassic) rock formations are from the Upper Lias and mainly consists of silty-clayey layers or heavily sandy.

### **4.6. Triassic**

It is the oldest period of the Mesozoic era which lasted between 252.2 and 201.3 million years ago. The Triassic period is divided into three subdivisions i.e. the Lower, the Mid and the Upper Triassic.

#### *4.6.1. Upper Triassic*

The Rhaetian sediments have high thickness in the Podlasie Depression area (118 m from Thuszcz borehole). The Rhaetian is represented by colored clayey sediments, often of mudstone, sandstone, dolomite or limestone texture. In the major part of the Podlasie Depression, the Keuper sediments are absent. In Warszawa Synclinorium, the Rhaetian is made of sandstones, claystones, breccia and dolomites of 250 m of thickness. Below, there are claystones and mudstones of a significant thickness (to 300 m). The Lower Keuper is made of sandstones, claystones and mudstones (from 30 to 100 m).

#### *4.6.2. Mid Triassic*

The Upper Muschelkalk is 10 m thick and consists mainly of limestone with fauna, nodular limestone, claystone and sandstone as well as dolomites. The Mid Muschelkalk is from 6 to 12 m thick and is represented by dolomites, marls and dolomitic limestones with claystones inserts. The Lower Muschelkalk consists of limestone and marl up to 20 m of thickness. In Warszawa Synclinorium, the Upper Muschelkalk is composed of 10 to 15 m thick limestone and claystone. Below, claystones and dolomites (5 to 15 meters) and limestones (10–26 m), which represent the Lower Muschelkalk are present.

#### *4.6.3. Lower Triassic*

The highest part of the Lower Triassic consists of series of limestones, claystones, sandstones and siltstones. The thickness of the Lower and the Mid Buntsandstein varies between 0 and 520 m. The Mid Buntsandstein is composed of sandstone, claystone and mudstone. The Lower Buntsandstein is represented by sandstone, mudstone, claystone, limestone, marl and conglomerates. In Warszawa Synclorium, the Upper Buntsandstein is represented by limestone and sandstone of up to 100 m. Below, there are claystones, sandstones, mudstones and oolitic limestones to 400 m.

### **4.7. Permian**

It is the uppermost system of the Paleozoic, which lasted between around 298.9 and 252.2 million years ago. It is divided into the Cisuralian, the Guadalupian and the Loping.

#### *4.7.1. Loping*

The lithology of the Upper Permian is formed variably in different borehole profiles in geological formations (Sokołowski 1968). Most characteristic are anhydrites and rock salt, which may be even tens of meters thick. In the upper part of the Upper Permian, colored clayey-carbonate layers, limestones and dolomites with clusters of anhydrites were found.

#### *4.7.2. Guadalupian*

In the Mid Zechstein, one may observe mainly clayey anhydrites. In the Mazowsze and in the eastern part of the Podlasie Depression (based on Magnuszew borehole), one may notice mainly dolomites in the lower parts of the Zechstein, but also thin white bed conglomerate and mudstones.

#### *4.7.3. Cisuralian*

The Lower Permian is composed of mainly thick complexes of clastic rock of very diverse and changeable grains. The lithological content of pebbles and minerals is diverse and varied, and is heavily reliant on the character and the petrographic constitution of formation rocks from neighboring areas. In the Podlasie Depression, mostly sandy-conglomerate sediments are present.

### **4.8. Carboniferous**

It was the fifth period of the Paleozoic era, which lasted from ca. 359 to ca. 299 million years ago and is divided into Mississippian and Pennsylvanian.

#### *4.8.1. Pennsylvanian*

The Upper Carboniferous formations developed into three stratigraphic series. The lowest series are mudstones with limestone inserts (e.g. Tyszowce, Dołhobyczów, Mircze, Husynne, Hrubieszów, Chełm, Michałów boreholes) and it reaches over 450 m of thickness in the South-East and is significantly decreasing towards the North and the North-West. Above, there are sandstones-mudstones series which are 200 m at most. In the marginally North-West part of the area, the series resides on the Silurian, whereas in the remaining parts – on a mudstone series with limestone inserts. The uppermost series is most commonly mudstone. The highest, concerning thickness, sections of this series was found in Dorohuczka, Żyrzyn and Magnuszew is over 1200 m. In the whole Upper Carboniferous profile in the Podlasie-Lublin area, 40 inserts and hard coal loads were observed.

#### *4.8.2. Mississippian*

The Lower Namurian sediments lie in accordance to the lowered part (i.e. Bystrzyca and Tyszowce) and their thickness exceeds 400 m, whereas in the northern platform area, it amounts to only tens of meters. Sediments in the upper part of the Carboniferous are characterized by a minor thickness i.e. from several to over 100 m. Limestone inserts rich in fauna were observed (these formations are included in the so called limestone-claystone series). The Turnaisian is represented by gangues, mostly colored and lithologically variable clastic rocks. Locally, the highest Turnaisian is characterized by sandstone-conglomerate series. The dolomitic (colored) facies series are around 200 m thick. The Visean sediments were found in all boreholes in the eastern part of Warszawa Synclinorium. These sediments form a limestone-claystone series and lie inconsistently on colored sediments included in the Turnaisian with thickness varied between 125 and over 230 m.

### **4.9. Devonian**

In the Devonian, the Famennian was not found. The Frasnian is represented by clayey shale and limestone. Below, limestones, clayey shale and dolomites, which are characteristic for the whole Mid Devonian are located. The oldest rocks of the Devonian are dark claystone, colored claystone and mudstone as well as sandstone.

### **4.10. Silurian**

The Silurian formations are mainly clayey and contain only graptolites. In the Podlasie Depression, in Białowieża region, carbonate facies are exclusive. Towards the West, it transforms into other (clayey-limy) sediments, whereas farther in the West i.e. near Siedlce, Tuszcz and Okuniew, clayey facies with graptolites are dominant. In Okuniew–Tuszcz–Żebrak area, on marly limestones of the Upper Ordovician (2358 m), there is a few centimeter

thick layer of black claystones with graptolites. Above, one may find developed dolomitic-limy claystones without graptolites. In the Upper part of the claystones, thin layers of black shale with graptolites are present. Above, there are the Wenlock and the Lower Ludlow sediments in the form of graptolite claystones. In Mielnik-Białowieża area, on the sediments from the Upper Ordovician, limy and marly claystones are located. The Llandovery sediments are absent. Sediments of limy claystones with limestone lenticels were found above, containing mainly graptolites and trilobites.

The lithostratigraphic profile of the Podlasie Basin is presented in Figure 8. Various scaled and averaged thickness of particular formation layers were applied in order to maintain maximum transparency of the presented profile.

## 5. INVESTIGATION OF LOOSE ROCK FORMATIONS

This section of research paper presents investigation of loose formation rocks from Quaternary, Paleogene and Neogene, which might be potentially drilled with rotary-percussion method. Based on the geological analysis, one may conclude that Quaternary, Paleogene and Neogene layers are characterized by a thickness of over 50 m (around 200–300 m). In certain analyzed boreholes, the following data was observed:

1. Mszczonów IG2 – the Quaternary to 95 m (clays, gravels, quartz sands, claystones), the Tertiary to 244 m (claystones, silts, secondarily marls).
2. Mszczonów IG1 – the Quaternary to 123 m (non-uniform sands and clays), the Tertiary to 311 m (claystones, sands, mudstones, marls, marly limestones, sandstones, mudstones; marl ceiling at the depth of 260.5 m).
3. Nadarzyn IG1 – the Quaternary and the Tertiary to 336 m (mostly sands, silts, claystones, at the depth of 258.40 m begins the marl and sandy spongiolite ceiling).
4. Okuniew IG1 – the Quaternary to 38 m (fine grained sands and gravels), the Tertiary to 268 m (sands, silts, gravels, lignite, marls – from 247 m).
5. Tuszcz IG1 – the Quaternary to 85m (sands, clays, claystones), the Tertiary to 208.60 m (sands, silts, from 200 m marls).
6. Łochów IG1 – the Quaternary and the Tertiary to 204.50 m (sand, loam, to 70 m also gravel).
7. Łochów IG2 – the Quaternary to 179 m (clays, sands, claystones, rarely gravel), the Tertiary to 193.50 m (sandy clay, sand with loam).
8. Żebrak IG1 – the Quaternary to 40 m (till, sands, silts), the Tertiary to 193 m (mostly sands, scarcely claystones, from 178.10 m marls and limestones, the latter being especially hard).
9. Wrotnów IG1 – the Quaternary to 122.5 m (sands, gravels, till, shales), the Tertiary to 215 m (loam, silt, sand, from 210 m gaizes and marls).
10. Stadniki IG1 – the Quaternary to 74,50 m (till, sands), the Tertiary to 187.50 m (clayey sands with claystone interlayers).

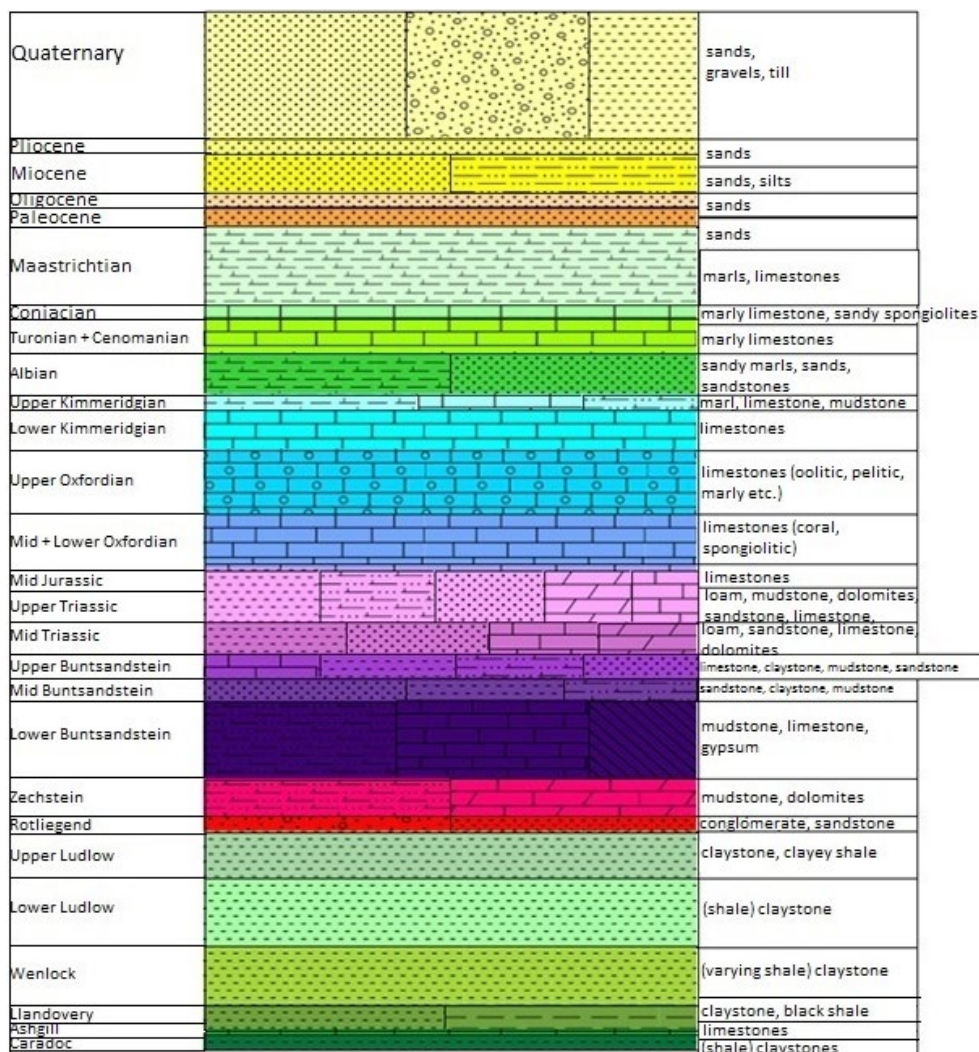

Fig. 8. The lithostratigraphic profile of the Podlasie Basin

Rys. 8. Profil litostratigraficzny basenu podlaskiego

11. Czyże IG1 – the Quaternary to 146 m (sands, till, claystones, silts), the Tertiary to 158 m (sandy mudstones).

## 6. ROTARY-PERCUSSION DRILLING METHOD

The rotary-percussion drilling method uses a down-the-hole hammer tool. Compressed air or fluid (for instance water) may be utilized as the drive, which is directed to the ham-

mer through rotating drill pipes. Air or water cleans the borehole out of cuttings, working as a scrubber. Working fluid flows out of the hammer through holes in the face of drill bit. The mechanism works as follows: the head, placed on the top of the rig, causes rotation, which are transferred to the hammer through the drill pipes. Since the pipes are linked with a thread, the drill string can be lengthened while drilling the borehole. Through the rotating mechanism and drill pipes pressure is conveyed to the drill bit. The down-the-hole (DTH) hammer, which is the mechanism producing percussion on the bottom of the borehole, facilitates almost 100% use of the energy. A top hammer system is less efficient, since only around 84% of the energy is transferred to the drill bit (Śliwa et al. 2011).

Example of water powered 8” down-to-hole hammer available at the market today is presented in Figure 9. Water powered DTH hammer is ideal choice for drilling in sensitive areas as well as for drilling longer and straight holes without potential dog legs. The DTH water powered hammer, as presented in Figure 9, is able to penetrate almost any rock formation while maintaining high penetration and accuracy (www.wassara.com).

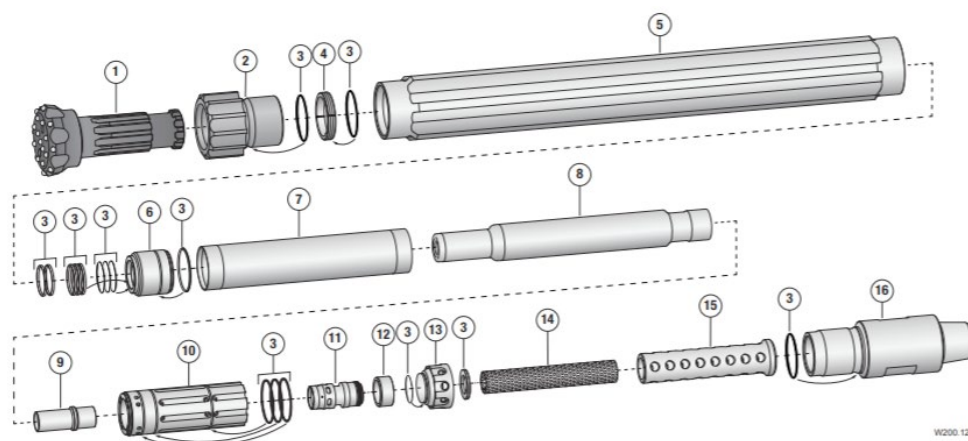

Fig. 9. Wassara's W200 DTH water-powered hammer (1 – drill bit, 2 – chuck, 3 – seal kit, 4 – bit retainer, 5 – hammer case, 6 – piston housing, 7 – inner tube, 8 – piston, 9 – sliding case, 10 – valve house, 11 – valve, 12 – sleeve, 13 – guided lid, 14 – filter, 15 – filter support, 16 – backhead API 4 1/2" IF) (source: www.wassara.com)

Rys. 9. Młotek wgłębny W200 firmy Wassara napędzany wodą (1 – świder wiertniczy, 2 – imadło, 3 – uszczelki, 4 – ustalacz, 5 – obudowa młotka, 6 – osłona pistonu, 7 – rura wewnętrzna, 8 – piston, 9 – element przesuwny, 10 – obudowa zaworu, 11 – zawór, 12 – rękaw, 13 – pokrywka, 14 – filtr, 15 – zabezpieczenie filtra, 16 – element łączący zestaw młotka z przewodem wiertniczym) (źródło: www.wassara.com)

## 6.1. Types of rotary-percussion drilling

Using the down-the-hole hammer, one may find two types of methods i.e. with a single and a double drill string.

### *6.1.1. Method with single drill string*

In this method of percussion drilling, the mechanism is based on a down-the-hole hammer, remotely controlled by an air compressor. It both drives the hammer and cleans the borehole from cuttings with compressed air. Drilling is executed mainly in solid rocks, where the risk of the wall falling apart is rather low. If the solid layer is preceded by a loose layers (typically from the Paleogene, the Neogene or the Quaternary), usually the initial drilling is performed with a casing string equipped with a drill bit to stabilize the wellbore walls. While assessing the effectiveness of the rotary-percussion method in the Podlasie Basin area, it was assumed that the initial drilling operations will be carried out for thickness of 50 m of formation rocks.

### *6.1.2. Method with double drill string*

This method consists of percussion drilling with simultaneous casing. The string consists of the lower and the upper head. The lower head rotates counter-clockwise. It rotates the outer drill string (casing string), whereas the upper head rotates the drill string with the device clockwise. The drill bit is assembled onto the casing string, while the drill string may utilize a hammer or saw tooth type of drill bits. This type of drilling method is used mostly in the loose or less concise rocks.

## **6.2. Drilling fluid and drill bits types**

To drill in formation rocks with the rotary-percussion method, one uses drill bit types of diverse structure:

- a) flat – used for hard, medium-hard and abrasive rocks (e.g. basalt, granite).
- b) concave – used for hard, medium-hard and homogenous rocks. It enables relatively easy control of the deviation and scrubbing of the bottom of the borehole.
- c) convex – used for soft and medium-hard rocks. It enables significant drilling progress.

Additionally, the progress of drilling is influenced by the shape of cemented carbides in the drill bit face. The type of cemented carbides with a spherical shape has a high resistance to cracking, but does not guarantee high penetration rates during drilling. The second is the semi-ballistic type, which has a good resistance to cracking (however lower than the spherical one), but it guarantees much higher drilling progress. Ballistic cemented carbides have high drilling speed, but are more vulnerable to cracking than the aforementioned types. On the opposite side is the cylinder type. It guarantees a very good drilling progress, but is highly vulnerable to cracking.

For rotary-percussion drilling, air, water or foam are commonly used as drilling fluids (also called wash). Pressure boosters are used to increase the pressure of the drilling fluid. Pressure boosters may increase the air pressure up to 20 MPa at once, and up to 170 MPa over few

stages. They are mostly used for drilling boreholes of sizeable depths, where high pressure of drilling fluid is necessary to reduce the loss of pressure and circulate cuttings out to the surface more efficiently. If water is used as a drilling fluid then, with pressure boosters, a borehole of around 3500 m can be drilled, however, for every 10 m of drilling, drilling fluid pressure needs to be increased by approximately 0.1 MPa and an additional 0.7 MPa needs to be put on the drill bit. Using a foam as a drilling fluid, the assumed depth may be increased from 20 up to 30%. Foam needs to be heavy, which enables the support of cuttings and their removal from the borehole to the surface. It may also aid the water transport from drilled rock formations, and upon high water influx, decrease the returning pressure on the hammer. Foam drilling fluid also increases efficiency of cleaning capabilities of the well bottom.

## CONCLUSIONS

Based on the geological analysis it may be assumed that Quaternary, Paleogene and Neogene layers' summary thickness is far greater than 50 m (around 200–300 m). These layers are rather loose and have to be cased prior to further drilling in deeper rock formations. The most beneficial would be an application of a rotary-percussion method with down-to-hole fluid hammer with simultaneous casing and load capacity appropriate for the depth of up to 300 m. Marl and limestone of the Upper Cretaceous are hard formation rocks, which are predisposed for the rotary-percussion method, as such method enables significantly higher penetration rates. The conditions for the rotary-percussion drilling method in the Podlasie Basin are worse than in Lublin Basin due to much thicker and loose formations of the Tertiary and the Quaternary periods.

The paper was created thanks to Statutory Research on Drilling, Oil and Gas Faculty, AGH University of Science and Technology no. 11.11.190.555.

## REFERENCES

- [Online] <http://geoportal.pgi.gov.pl/portal/page/portal/otwory> [Accessed: 2016-05-12].
- [Online] <http://www.geologia.republika.pl/> [Accessed: 2016-05-15].
- [Online] <https://www.wassara.com/> [Accessed: 2016-04-13].
- [Online] [pl.wikipedia.org](http://pl.wikipedia.org) [Accessed: 2016-05-10].
- [Online] [www.ekologia.pl](http://www.ekologia.pl) [Accessed: 2016-05-07].
- Areń, B. 1974. *Profile Głębokich Otworów wiertniczych – Thuszcz IG1, Zeszyt 13*. Warszawa: Wydawnictwo Geologiczne.
- Areń, B. 1975. *Profile Głębokich Otworów wiertniczych – Okuniew IG1, Zeszyt 29*. Warszawa: Wydawnictwo Geologiczne.
- Areń, B. 1978. *Profile Głębokich Otworów wiertniczych – Łochów IG1, Łochów IG2, Zeszyt 44*. Warszawa: Wydawnictwo Geologiczne.



- Dębowska, J. i Marek, S. 1988. *Profile Głębokich Otworów wiertniczych – Mszczonów IG1, Mszczonów IG2, Nadarzyn IG1, Zeszyt 65*. Państwowy Instytut Geologiczny, Warszawa: Wydawnictwo Geologiczne.
- Jarmołowicz-Szulc, K. 1996. *Profile Głębokich Otworów wiertniczych – Czyże IG1, Zeszyt 85*. Warszawa: Państwowy Instytut Geologiczny.
- Jaroszewski, W. 1986. *Przewodnik to ćwiczeń z geologii dynamicznej*. Warszawa: Wydawnictwa Geologiczne.
- Lendzion, K. 1975. *Profile Głębokich Otworów wiertniczych – Żebrak IG1, Zeszyt 28*. Warszawa: Wydawnictwo Geologiczne.
- Ocena zasobów wydobywalnych gazu ziemnego and ropy naftowej w formacjach łupkowych dolnego paleozoiku w Polsce (Basen Bałtycko-Podlasko-Lubelski)*. Polish Geological Institute's report, Warszawa, March 2012, [Online] [www.pgi.gov.pl/pl/dokumenty-in-edycja/doc\\_view/771-raport-pl.html](http://www.pgi.gov.pl/pl/dokumenty-in-edycja/doc_view/771-raport-pl.html) [Accessed: 2016-05-07].
- Peryt et al. 2004 – Peryt, T., Piwocki, M. and Badura, J. 2004. *Stratygrafia. Cz.3a, Kenozoik, paleogen, neogen*. Warszawa: Państwowy Instytut Geologiczny.
- Podhalańska, T. 2008. *Profile Głębokich Otworów wiertniczych – Wrotnów IG1, Zeszyt 126*. Warszawa: Państwowy Instytut Geologiczny.
- Podhalańska, T. 2011. *Profile Głębokich Otworów wiertniczych – Stadniki IG1, Zeszyt 132*. Warszawa: Państwowy Instytut Geologiczny.
- Pozaryski, W. 1974. *Budowa Geologiczna Polski, tom IV, Tektonika, część 1., Niż Polski*. Warszawa: Wydawnictwo Geologiczne.
- Ryka, W. and Maliszewska, A. 1982. *Słownik petrograficzny*. Warszawa: Wydawnictwo Geologiczne.
- Sokołowski, S. and Baraniecka, M. 1984. *Stratygrafia. Cz. 3b, Kenozoik, the Quaternary*. Warszawa: Wydawnictwo Geologiczne.
- Sokołowski, S. and Birkenmajer, K. 1973. *Stratygrafia. Cz. 2, Mezozoik*. Warszawa: Wydawnictwo Geologiczne.
- Sokołowski, S. and Bukowy, S. 1968. *Stratygrafia. Cz. 1, Prekambr and Paleozoik*. Warszawa: Wydawnictwo Geologiczne.
- Stupnicka, E. 1997. *Geologia Regionalna Polski*. Warszawa: Wydawnictwo Uniwersytetu Warszawskiego.
- Śliwa i in. 2011 – Śliwa, T., Mazur, M., Gonet, A. i Sapińska-Śliwa, A. 2011. Wiercenia udarowo-obrotowe w geoenergetyce. *AGH Wiertnictwo, Nafta, Gaz* vol. 28, no. 4, [Online] [journals.bg.agh.edu.pl/WIERTNICTWO/2011-04/W\\_2011\\_4\\_12.pdf](http://journals.bg.agh.edu.pl/WIERTNICTWO/2011-04/W_2011_4_12.pdf) [Accessed: 2016-05-07].
- Zubrzycki, A. 2011. *Podstawy Geologii Naftowej*. Kraków: Wydawnictwo AGH.

# POTENCJALNA APLIKACJA METODY OBROTOWO-UDAROWEJ W OTWORACH ZA GAZEM ŁUPKOWYM W REJONIE BASENU PODLASKIEGO

## STRESZCZENIE

Poniższa praca przedstawia badania nad potencjalnym wykorzystaniem metody udarowo-obrotowej w celu wiercenia formacji skalnych występujących tuż nad pokładami złóż gazu łupkowego w rejonie basenu podlaskiego. W poniższym artykule została przeprowadzona analiza skał łupkowych wraz z ich wiekiem, dojrzałością materii organicznej oraz miąższością poszczególnych warstw. Na skutek dość zróżnicowanej miąższości formacji skalnych, głębokość zalegania warstw nie została określona z powodu dużego błędu przy uśrednieniu ich wartości. Wyskalowane oraz uśrednione miąższości zostały przedstawione w celu utrzymania spójności i przejrzystości pracy. Należy nadmienić, że formacje skalne z okresu dewońskiego oraz karbońskiego nie występują we wszystkich profilach z okresu paleozoiku basenu podlaskiego, a jedynie w jego południowo-zachodnich częściach. Pominięto lokalnie występujące (tj. na południowo-wschodniej granicy) warstwy dewońskie oraz karbońskie. Profil litostratygraficzny z zachowanymi proporcjami pomiędzy średnimi miąższościami poszczególnych warstw skalnych został skonstruowany oraz przedstawiony w końcowej części pracy. Badania w poniższym artykule zostały dodatkowo uzupełnione danymi szacunkowymi zasobów gazu łupkowego na terenie Polski. Obszar basenu bałtyckiego jest obecnie najbardziej lukratywny pod względem wydobycia gazu ze skał łupkowych z powodu dużej ilości udokumentowanych oraz jeszcze nierozpoznanych złóż tego surowca. Obszary basenu podlaskiego oraz lubelskiego są drugie oraz trzecie w kolejności pod względem ilości zasobów gazu łupkowego na terenie Polski.

Metoda udarowo-obrotowa pozwala na dużo szybsze zwiercanie formacji skalnych przy użyciu podobnych parametrów mechanicznych takich jak nacisk na świder i prędkość obrotowa niż przy standardowym procesie wiercenia metodą obrotową. Poniższy artykuł odpowiada na pytania takie jak: w jakich warunkach możliwe jest wiercenie metodą udarowo-obrotową oraz jakie rodzaje płuczek wiertniczych są najbardziej odpowiednie do wiercenia taką techniką. Metoda udarowo-obrotowa zapewnia nie tylko dużo większy postęp wiertniczy, ale również dużo mniejsze odchylenia od osi otworu oraz zapobiega nagłym zmianom kierunku podczas procesu wiercenia. Wiertnica oraz osprzęt zapuszczany do otworu stosowany podczas wiercenia metodą udarowo-obrotową zajmuje znacznie dużo mniej miejsca w porównaniu z głębokimi wierceniami konwencjonalnymi metodami. Dzięki wspomnianym zaletom metoda udarowo-obrotowa może zostać potencjalnie wykorzystana przy wierceniu otworów za gazem łupkowym w obszarze basenu podlaskiego.

## SŁOWA KLUCZOWE

Gaz łupkowy, technologia wiercenia, wiercenia udarowo-obrotowe, basen podlaski