

STUDY OF TUNDISH SLAG ENTRAINMENT USING PHYSICAL MODELLING

This paper deals with the possibilities of using physical modelling to study the slag entrainment in the tundish. A level of steel in the tundish is changing during sequential continuous casting. The most significant decrease in the steel level occurs when replacing ladles. It is generally known that if the height of steel level in the tundish drops below a certain critical level, it may generate vortexes over the nozzles and as a consequence entrainment of tundish slag into individual casting strands can occur. Thus, it is necessary to identify the critical level of steel for specific operational conditions. In this paper, the development of physical modelling methodology is described as well as physical model corresponding to operational continuous casting machine No. 2 in Třinecké železářny, a.s. The obtained results are discussed.

Keywords: steelmaking, tundish, slag entrainment, vortex, physical modelling

1. Introduction

Inseparable part of the technology of steel production in the most modern metallurgical companies is continuous casting machine (CCM). Very important is continuous steel solidification of sequentially cast heats. The tundish is a technological node ensuring the continuous steel inflow to the mould, also at the time when exchanging of ladles on the stand is done.

The process of ladles exchange must be adjusted in appropriate way: the input of steel from the following heat (from the ladle) must be ensured before emptying the tundish where the steel of the previous heat is flowing out. Otherwise, there will be interruptions in the continuous casting process.

However, it is not possible to allow decreasing the steel level in the tundish under certain critical level, even when casting is finishing on the last heat in the sequence. The tundish slag is present on the molten steel in the tundish. It plays the isolating and partly also the refining role. It is also necessary to prevent not only the whole tundish emptying but also the entrainment of the present slag into the individual casting strands. Slag entrainment and steel impurities entering the mould can occur exactly at decreased critical level of steel in the tundish when vortex is created causing slag entrainment through the nozzle into the mould. It is necessary to identify unequivocally such critical bath level and prevent its reduction and creation of vortexes in the industry practice.

Physical modelling is commonly used for optimization the technology of steel and nonferrous metals production [1-6], therefore such modelling can be also used to determinate the critical level of steel bath in the tundish to prevent tundish

slag from entrainment [7].

There are a lot of works [8-17] concerned the problem of the physical modelling of slag entrainment in the metallurgical aggregates. These works mainly focus on setting and adapting the theory of similarity for the case when liquids with various density and viscosity have to simulate steel and slag.

Authors [11] basing on experimental results stated that, when physical modelling is applied to processes connected with slag entrainment, it is more significant the ratio of inertia and gravitational forces (Froude criterion, Fr) (1) than ratio of inertia and viscous forces (Reynolds criterion, Re) (2).

$$Fr = \frac{\omega^2}{g \cdot l} \quad (1)$$

where:

ω - the speed of liquid flowing; m.s⁻¹,
g - gravitational acceleration; m.s⁻²,
l - characteristic dimension; m.

$$Re = \frac{\omega \cdot l}{\nu} \quad (2)$$

where:

ν - kinematic viscosity; m².s⁻¹.

Using such models when two immiscible liquids are used for the study of slag entrainment, it is possible to consider the ratio of their densities as significant whereas the influence of ratio of kinematic viscosities as negligible [11]. That is why, many authors used the modified Froude criterion (Fr_{mod}) as governing for the setting of similarity of flowing between the model and real system. The original Fr criterion (1) is

* VŠB-TECHNICAL UNIVERSITY OF OSTRAVA, FACULTY OF METALLURGY AND MATERIALS ENGINEERING, DEPARTMENT OF METALLURGY AND FOUNDRY, AND REGIONAL MATERIALS SCIENCE AND TECHNOLOGY CENTRE, 17. LISTOPADU 15/2172, OSTRAVA-PORUBA, CZECH REPUBLIC

** SILESIAN UNIVERSITY OF TECHNOLOGY, FACULTY OF MATERIALS ENGINEERING AND METALLURGY, UL. KRASIŃSKIEGO 8, KATOWICE, POLAND

*** TŘINECKÉ ŽELEZÁŘNY, A.S., PRŮMYSLOVÁ 1000, TŘINEC-STARÉ MĚSTO, CZECH REPUBLIC

[#] Corresponding author: karel.michalek@vsb.cz

supplemented by various ratios of densities of the immiscible liquids. Examples of modified Froude numbers Fr_{mod} presented by some authors are given in following equations (3, 4) [9,18]:

$$Fr_{mod} = \frac{\omega^2}{g \cdot l} \cdot \frac{\rho_1}{\rho_2} \tag{3}$$

where:

ρ_1 - density of lighter liquid; $kg.m^{-3}$,

ρ_2 - density of heavier liquid; $kg.m^{-3}$.

$$Fr_{mod} = \frac{\omega^2}{g \cdot l} \cdot \frac{\rho_2}{\rho_2 - \rho_1} \tag{4}$$

One of the research stage was to find a system of two liquids with suitable combinations of density which ensure the creation of vortex at the surface level relevant for operational conditions. Following partial results of works [8-16] a trend was found to increase the critical level with the application of liquid with lower density.

Critical levels for vortex creation were compared and discussed in the paper [14]. When the paraffin oil was applied, the critical level for vortex creation was at the height of 191 mm, when paraffin oil with low viscosity was used, then the height was 195 mm. Assuming that experiments were realized without the second phase, only in the presence of atmosphere, the critical level of 200 mm for vortex creation was the highest.

Viscosity and density of slag are very variable under real operational conditions in steel plants and are influenced by a whole range of continuously changing factors. They cannot be generally imitated by using of any combination of modelling liquids. Furthermore, it was shown that the highest critical levels are reached when the experiments are realized without the presence of liquids simulated slag. It is really important to determine the lower critical level of surface for the vortex creation in the tundish, thus in the real conditions it would be possible to prevent from such situation.

2. Experimental methodology

The aim of this work was to determine the critical level of the steel bath for development of vortexes in individual casting strands of tundish at units of continuous steel casting No. 2 (CCM2) located in Třinecké železářny, a.s. Fig. 1 shows the configuration of the tundishes in CCM2.

Two tundishes, each with the nominal working weight 15 tons are symmetrical placed under the ladle with the nominal steel weight 180 tons placed in the casting stand. Fig. 1 shows also the arrangement of shroud and each of eight casting strands (which are symmetrical).

In the 1990th, physical model of tundish B (see Fig. 1 - left side) with casting strands 5 to 8 (CS5 to CS8) was built in the grounds of Třinecké železářny, a.s. This physical model was built in the geometrical scale $M_1 = 1:3$. As the main criterion the Froud number Fr was used, in the form given in the equation (1). The correct setting of the similarity system between the model and the real tundish was confirmed with

the whole range of operationally verified experimental works focused on study of character of casting in the tundish in order to optimize the range of intermixed zone [19] and the inner arrangement of tundishes [20].

Thus, to find the critical level of steel bath for the entrainment of tundish slag it was decided that research will be conducted in this proved model with the current inner arrangement – see Fig. 2.

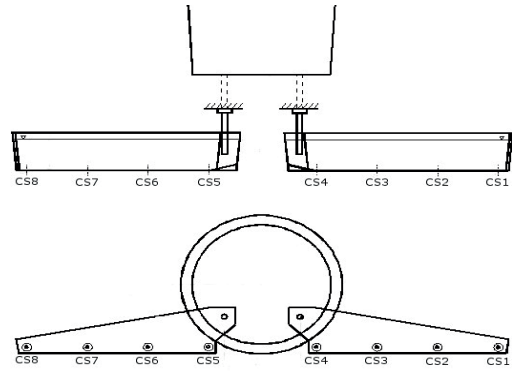

Fig. 1 Configuration of the ladle and tundishes in CCM2

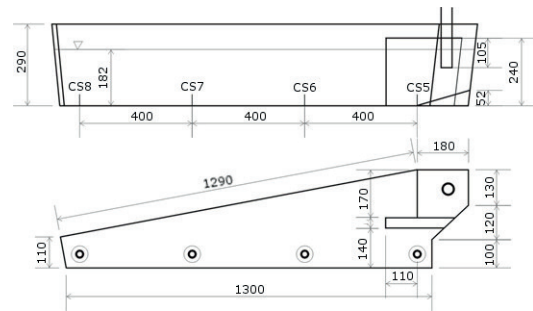

Fig. 2 Scheme of tundish B of physical model CCM2 in the geometrical scale $M_1 = 1:3$

According to the Třinecké železářny, a.s. suggestions the simulations were done for two current operational casting speeds: $v_1 = 2.1 m.min^{-1}$; $v_2 = 2.5 m.min^{-1}$.

The above analysis and own previous experiments enable to limit the studied system to two phases: water – air. It was established that in this way relevant critical level of steel bath in the tundish will be determined after the recalculation to the conditions of the real tundish. As a governing criterion Froude criterion $Fr(1)$ was chosen. So, the real casting speeds: 2.1 and 2.5 $m.min^{-1}$ were recalculated to 3.35 and 4 $l.min^{-1}$ respectively on water model.

An aqueous solution of potassium permanganate ($KMnO_4$) was used for visualisation of vortex development above the individual nozzles entrances of casting strand. Two cameras were used for simultaneous recording of each experiment. First one was zoomed in from the side of individual outlet (nozzle entrance), whereas the second was positioned to record the flow from the top view.

Each experiment starts with filling through shroud the tundish up to the level of 18.2 cm (12 tons of steel in real tundish). Then, the inflow was stopped and emptying of tundish starts - like in real conditions during finishing the casting of heat by defined outflow (3.35 $l.min^{-1}$, 4 $l.min^{-1}$).

3. Results and discussion

Based on such methodology, series of 24 experiments were carried out. For each cast strand and outflow rate, three experiments were realised and recorded by two cameras as mentioned earlier. Records were analysed and five typical stages of vortex development were observed on each casting strand, see Fig. 3-7.

Basing on the identified stages of tundish emptying, all records were analysed and level heights for each defined stage were written. It was assumed that the risk of slag entrainment in the real tundish conditions is observed when the rotation leads to the vortex beginning. The relevant data were recalculated to real mass of steel in the tundish. Table 1 summarized the critical weight of steel remaining in the tundish when vortex begins.

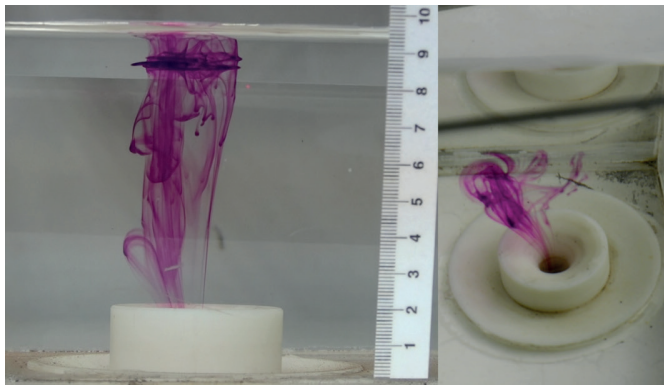

Fig. 3 The start of flow rotation around the CS8; 4 l.min⁻¹ outflow

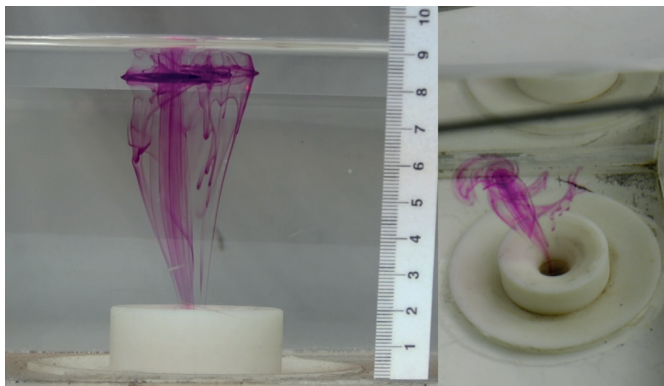

Fig. 4 The beginning of vortex flow at the CS8; 4 l.min⁻¹ outflow

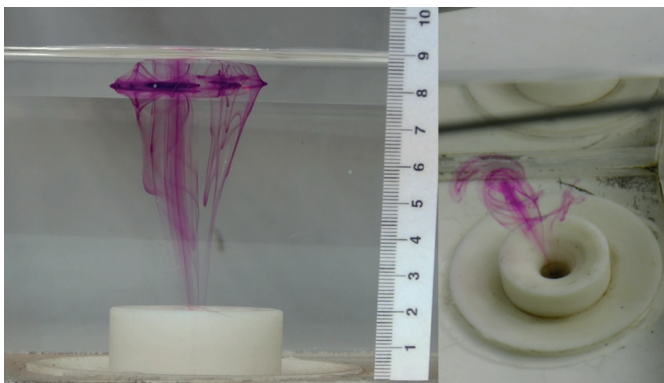

Fig. 5 The fully developed vortex at the CS8; 4 l.min⁻¹ outflow

When the 2.1 m.min⁻¹ casting speed was simulated, the critical weight of steel remaining in the tundish during its emptying was very similar for all four CS (from 3.2 to 3.6 tons). When higher casting speed (2.5 m.min⁻¹) was applied, critical steel level for CS5 was comparable with that during experiments with slower casting speed. Moreover, the critical steel level for CS7 (2.9 tons) was the lowest of all. On the other hand, the highest critical bath levels were found above CS6 and CS8 (4.8; 4.9 tons respectively).

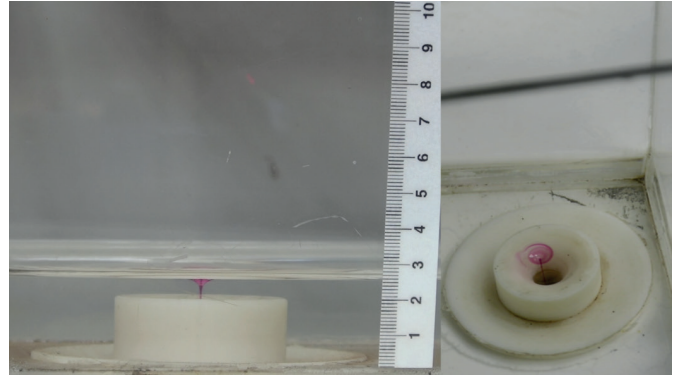

Fig. 6 The depression of bath level above the CS8; 4 l.min⁻¹ outflow

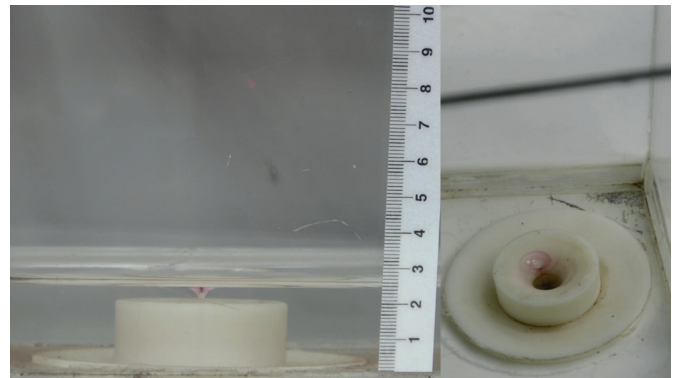

Fig. 7 The air entrainment into the CS8; 4 l.min⁻¹ outflow

TABLE 1
Critical weight of steel remaining in the tundish

Casting Speed, m.min ⁻¹	Casting Strand No.	Steel Mass in Tundish, tons
2.1	5	3.2
	6	3.6
	7	3.5
	8	3.2
2.5	5	3.4
	6	4.8
	7	2.9
	8	4.9

The higher variability of critical bath levels of steel remaining in the tundish during its emptying determined for higher physically modelled casting speed (2.5 m.min⁻¹) is connected with more intensive outflow - this leads to more non-uniform steel flow in the tundish volume. Generally, higher critical bath levels for higher casting speed are in accordance with the general assumption.

It was found that during continuous casting process of steel on CCM2 the steel weight remaining in the tundish should not drop below maximum critical levels for each casting speed as stated in tab. 1, i.e.:

- 3.6 tons for 2.1 m.min⁻¹ casting speed,
 - 4.9 tons for 2.5 m.min⁻¹ casting speed
- to prevent the slag entrainment to the tundish nozzles and as a consequence to the mould.

4. Conclusions

The aim of presented work was to study of tundish slag entrainment using physical modelling. Based on references analysis and own previous experiences, the methodology of physical modelling was developed and series of 24 relevant experiments was realised.

The following conclusions were drawn:

1. Taking into account the theory of similarity, Froude criterion (1) was chosen as a governing criterion. The critical level of vortex creation was determined using water as a modelling agent.
2. Five typical stages of vortex development were observed: the start of flow rotation, the beginning of vortex flow, the fully developed vortex, the depression of bath level and the air entrainment into the casting strand.
3. It was assumed that the risk of slag entrainment in the real tundish conditions begins when the rotation leads to the vortex beginning.
4. For both simulated casting speeds (2.1 and 2.5 m.min⁻¹), the critical weight of steel remaining in the tundish to prevent the top slag entrainment was determined: 3.6 and 4.9 tons respectively.

Acknowledgement

The work was carried out in the frame of project No. TA04010312 "Utilization of laser triangulation method with the aim of optimizing technology for surface quality improvement of steel intermediate products" solved with the financial support of TA CR.

This work was created with the support of projects of Student Grant Competition No.: SP2015/78, SP2015/70.

This paper was created in the Project No. LO1203 "Regional Materials Science and Technology Centre - Feasibility Program" funded by Ministry of Education, Youth and Sports of the Czech Republic.

REFERENCES

- [1] K.M. Godiwalla, S.K. Sinha, C.S. Sivaramakrishnam, *Steel Research Int.* **65**, 7, 267-271 (1994).
- [2] S.C. Koria, S. Singh, *ISIJ Int.* **34**, 10, 784-793 (1994).
- [3] D. Mazumdar, R.I.L. Guthrie, *ISIJ Int.* **35**, 1, 1-20 (1995).
- [4] B. Li, F. Tsukihashi, *ISIJ Int.* **40**, 12, 1203-1209 (2000).
- [5] H.J. Odenthal, H. Pfeifer, M. Klaas, *Steel Research Int.*, 71, 6-7, 210-220 (2000).
- [6] A. Ruckert, M. Warzecha, R. Koitzsch, M. Pawlik, H. Pfeifer, *Steel Research Int.* **80**, 8, 568-574 (2009).
- [7] D. Mazumdar, J. W. Evans, *Modelling of Steelmaking Processes*. Boca Raton: CRC Press, 2010.
- [8] D. Mazumdar, O.P. Singh, J. Dutta, S. Ghost, D. Satish, S. Charakborty, *Transactions of the Indian Institute of Metals.* **64**, 6, 593-605 (2011).
- [9] G. Dharmendra, A.K. Lahiri, *Metallurgical and Materials Transactions B* **27B**, 4, 695-697 (1996).
- [10] D. Gupta, A.K. Lahiri, *Metallurgical and Materials Transactions B* **25B**, 2, 227-233 (1994).
- [11] R. W. Paul, F. T. Whitaker, *The Relationship of Basic Tundish Powder Properties to Tundish Practises and Steel Quality*. In *Proceedings of Electric Furnace Conference Atlanta, USA* **50**, 197-206 (1992).
- [12] R. Sankaranarayanan, R.I.L. Guthrie, *Ironmaking and Steelmaking* **29**, 2, 147-153 (2002).
- [13] G. M. Mazzaferro, M. Piva, S. P. Ferro, P. Bissio, M. Iglesias, A. Calvo, M. B. Goldschmit, *Ironmaking and Steelmaking* **31**, 6, 1-6 (2004).
- [14] R.D. Morales, O. Davila-Maldonado, I. Calderon, K. Morales-Higa, *ISIJ Int.* **53**, 5, 782-791 (2013).
- [15] D.R. Heaslip, *Caster Steel Yield Improvement by Enhanced Ladle Bottom Design*, Conference AISTech, 127-134 (2007).
- [16] S.C. Koria, U. Kanth, *Steel Res. Int.*, **65**, 1, 8-14 (1994).
- [17] J. Pieprzyca, T. Merder, M. Saternus, H. Kania, *Archives of Metallurgy and Materials* **59**, 4, 1443-1450 (2014).
- [18] K. Michalek, *Využití fyzikálního a numerického modelování pro optimalizaci metalurgických procesů*. VŠB-Technická univerzita Ostrava, Ostrava 2001.
- [19] K. Michalek, K. Gryc, M. Tkadlečková, D. Bocek, *Archives of Metallurgy and Materials* **57**, 4, 291-296 (2012).
- [20] K. Gryc, K. Michalek, Z. Hudzieczek, M. Tkadlečková, *Physical Modelling of Flow Pattern in 5-strand Asymmetrical Tundish with Baffles*, Conference proceedings METAL 2010, 42-46 (2010).