

COMPARISON OF COMBUSTION OF GASOLINE AND METHANOL IN THE SI ENGINE DUAL FUELLED

Zdzisław Stelmasiak

Technical University of Bielsko-Biala
Faculty of Mechanical Engineering and Computer Science
Willowa Street 2, 43-309 Bielsko-Biala, Poland
e-mail: zstelmasiak@ath.bielsko.pl

Abstract

In the paper are presented comparative tests of combustion of gasoline and combustion of methanol in spark ignition engine of the Fiat 1100 MPI type. The engine was equipped with a prototype suction manifold with duplex injectors on each cylinder. Implemented system enabled dual fuel operation of the engine with any fraction of the alcohol. Engine performance and start-up capabilities were the same like in case of the operation on gasoline only. Type and parameters of the fuel supply can be changed in any time during operation of the engine. The study dealt with comparison of a selected parameters used to assessment of combustion of the fuels: pressure of the working medium p , rate of pressure rise $dp/d\alpha$, heat release rate $dQ/d\alpha$, temperature of the working medium, and combustion angle. The investigations pointed at considerable differences in run of combustion of the gasoline and combustion of the methanol, as autonomous fuels. Moreover, addition of methanol to gasoline results in considerable differences in combustion process, comparing to combustion of gasoline mixtures. The combustion goes on more dynamically, especially during initial phase of the process, while total time of the combustion is shorter. Effects of these changes are: higher maximal pressures, faster rates of pressure growth and heat release. Extent of change of combustion parameters depends on methanol fraction in total dose of the fuel supplied to the engine. Addition of the methanol effects in growth of general efficiency of the engine, which increases together with growth of methanol fraction and engine load. Absolute growth of the efficiency amounted to 2-5%, while relative growth amounted to 6-16%. Such significant growth of the efficiency should lead to reduction of energy consumption during engine operation.

Keywords: methyl alcohol, gasoline, spark ignition engine, combustion parameters, thermal efficiency, dual fuelling

1. Introduction

Methyl and ethyl alcohols, due to their advantageous properties, high octane numbers, and high vaporization heat, have been used for years as components of engine fuels [1-3, 6-11]. Initially, they were used as additives to gasoline, leveraging octane number, and were used in order to reduce maximal temperatures of the working medium during combustion in heavy duty sports engines [12, 14]. The alcohols had gained big popularity during the 1st and the 2nd World War, due to shortage of petroleum fuels, and during seventies of the previous century, during fuel crisis and growth of crude oil price.

The both fuels mentioned above belong to group of bio-fuels, and hence to reproducible sources of energy; use of such fuels is supported by governments of many states. Due to it, recently is carried out intensive worldwide research focused at sourcing and usage of the alcohols to fuelling of the engines. Big attainments in this field are observed in such countries as USA, Sweden, Germany and Italy [11, 15, 17]. Especially high hopes are connected with use of ethanol of the 2nd generation, produced from cellulose, what should contribute to more wide use of the alcohol to fuelling of the engines.

One from a serious operational problems connected with fuelling with the alcohol is stratification of gasoline-alcohol mixtures and Diesel oil – alcohol mixtures in low temperatures and in presence of water [2, 10, 11]. Due to it, contents of the alcohols in European climatic zone did not exceed, as a rule, 10%v. One increases such contents by use of a stabilizers, like methyl-

tert-buthylene or ethyl-tert-buthylene esters among others, or use of ternary mixtures of gasoline-alcohol-benzene (having limited life). Despite these additives, contents of the alcohols in the mixtures wouldn't exceed, as a rule, 20%v.

A solution could be also usage of anhydrous alcohols, what would enable creation of gasoline mixtures with any contents of alcohols. This process results, however, in increase of already high prices of the alcohols, and additionally, due to hygroscopicity of the alcohols, life of these mixtures is limited.

From implementation in the engine point of view, more advantageous is usage of the alcohols as a pure fuel. It enables taking full advantage of high knocking resistance of the alcohols, what allows increase of compression ratio, growth of overall efficiency and unit power output of the engine [2, 3, 7-9, 11]. This direction is particularly well-developed in Brazil, but is also present in USA, New Zealand and Sweden, among others [1, 3, 4, 11, 18-21].

Except stratification of alcohol-gasoline mixtures, low volatility of the vapours is the second main drawback of the alcohols, what at negative ambient temperatures can lead to lack of ignition [1-3, 10, 16, 17].

The drawbacks discussed above were eliminated by use of a prototype fuel supply system, used in the research work presented here and described in the works [11, 12, 14]. In serial Fiat 1100 MPI engine on mounted a prototype suction manifold with two injectors for each cylinder, to injection of gasoline and alcohol. Mixing of the both fuels occurs in the cylinder directly before combustion. Proposed system enables fuelling of the engine with alcohol only, or gasoline only, or gasoline-alcohol mixture with any fraction of the alcohol. Among the obvious advantages of this system one should specify: possibility of engine start-up on the gasoline only, and continued operation with any fraction of the both fuels, depending on engine rotational speed and load.

In the paper are presented comparative tests of the Fiat 1100 MPI engine operated in dual fuel system, fuelled with gasoline and methyl alcohol, popularly called as methanol.

Subject-matter of the analysis was comparison of selected parameters of combustion, when the engine is fuelled with the gasoline and with methanol, and with gasoline-methanol mixtures.

2. System of dual fuel supply of spark ignition engine

Scheme of prototype suction collector is presented in the Fig. 1, whereas adaptation of the fuel rail is shown in the Fig. 3.

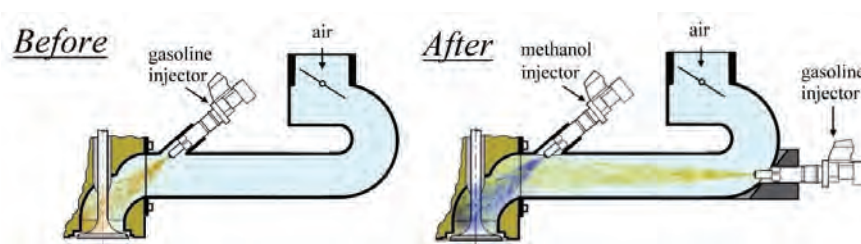

Fig. 1. Schema of the prototype inlet manifold of engine Fiat 1100 MPI

In the design solution presented in the Fig. 1, injection of the fuels is accomplished with use of separate injectors: injection of the methanol through factory assembled injector, injection of the gasoline through additional injector, positioned away the inlet valve, what is a drawback of the system. Moreover, such solution increases adaptation costs of the engine to dual fuel supply.

Another solution could be usage of additional mixer of the both fuels, positioned upstream the fuel rail of factory mounted injectors. Design solution of such fuel supply system, consisting in use of a joint mixer for the gasoline and the methanol, and multipoint injection of mixture of the both fuels to the suction manifold through factory assembled injectors, totally eliminates problem of stratification of alcohol-gasoline mixtures and only slightly increases adaptation costs of the engine.

Supply of the both fuels mixture directly to fuel collector of the injection system, largely limits the delay resulted from change of fuel composition supplied to the cylinder, and simultaneously restricts its stratification.

In case of fuelling with various fuels, the fuels are mixed in condition of working pressure occurring in the injection system (3.5 bar).

Presented solution was developed as result of experience gained during testing of the Fiat 1100 MPI engine equipped with the system presented in the Fig. 1. Proposed solution consists in mixing of the both fuels (gasoline and alcohol) upstream the fuel collector. Such solution is more universal comparing to the solution with two sets of injectors. Concept and functional prototype of the dual fuel supply system, which is the main element of dual fuel supply system, was prepared for the Fiat 1100 MPI engine. In the engine, adjustment of injection pressure is performed with use of a control valve located near the fuel supply pump. In such case, injection pressure control valve, located near the fuel collector is not used. In case of fuelling with two different fuels, the fuels should be mixed in conditions of working pressure occurring in the injection system (3,. bar). In the Fig. 2 is presented a scheme of fuelling system of the investigated engine run on the gasoline and the methanol.

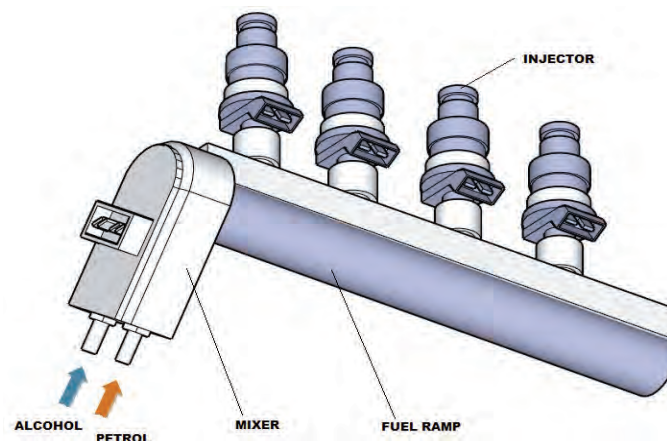

Fig. 2. Scheme of the fuels mixer [5]

3. The engine and the test stand

The tests were performed on 4 cylinders spark ignition engine with multipoint injection of the Fiat 1100 MPI type. Technical data of the engine are presented in the Tab. 1.

Tab. 1. Technical data of engine Fiat 1100 MPI

Engine type	Fiat 1100 MPI
Bore x Stroke	70 x 72 mm
Displacement	1108 cm ³
Compression ratio	9.6
Maximal power/engine revolution	40 kW/5000 rpm
Maximal torque/ engine revolution	88 Nm/3000 rpm

Serial production engine was adapted to the dual fuel supply by usage of prototype suction collector shown in the Fig. 1.

In adaptation of the engine one took assumption, that in dual fuel supply the alcohol shall be injected by original injectors, while gasoline shall be injected by additional injectors. Prototype suction manifold with the injectors after rework and adaptation to the Fiat 1100 MPI engine is depicted in the Fig. 3.

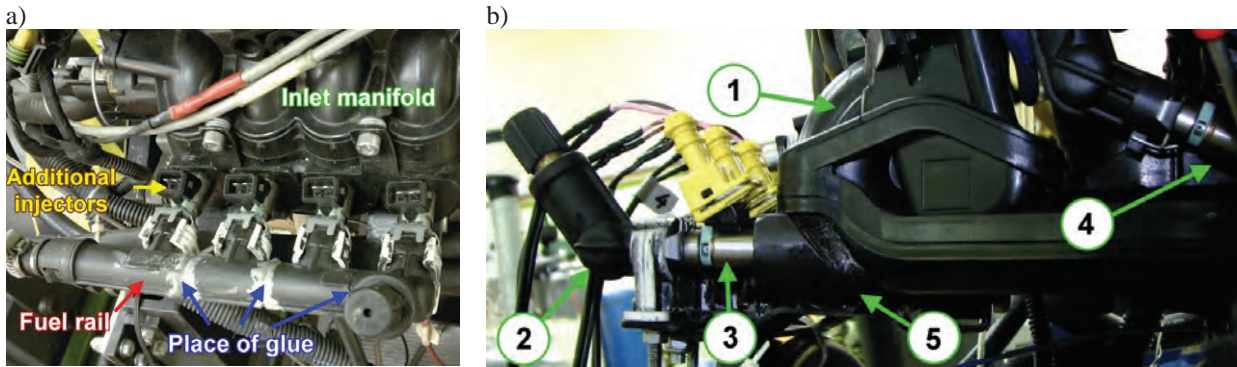

Fig. 3. Adaptation of fuel rail: a) view of fuel rail, b) prototype intake manifold: 1- manifold, 2 - fuel rail, 3 - gasoline injector, 4 - methanol injector, 5 - position where sleeve of the injector is glued

To indication of fast-changing pressures in combustion chamber one used the INDIMETER 619 system made by AVL. There was used not-cooled pressure sensor from the AVL, located in cylinder head of the second cylinder.

In the test stand one used a system to automatic acquisition of measuring data to the Excel calculation sheet. Recorded values were taken directly from the files in programs to processing of the measurement data.

In the test stand one installed a duplex fuel supply system for the alcohol and the gasoline. Each system was equipped with individual fuel pump with pressure stabilization system and system to measurement of fuel consumption. Fuel system enabled control of transient fuel consumptions, what considerably facilitated selection of engine set-up. Sizes of the doses were dependent on fraction of the fuels, engine load and rotational speed. View of the test stand is shown in the Fig. 4.

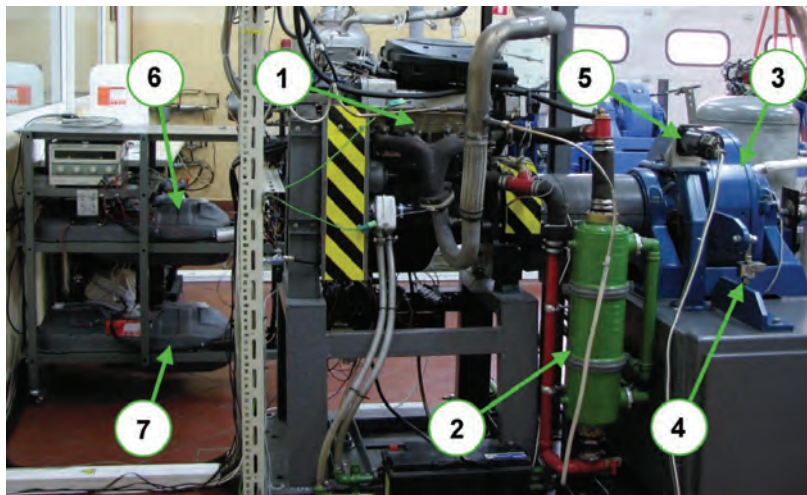

Fig. 4. Test stand - general view: 1 - research engine of Fiat 1100 MPI type, 2 - water cooler, 3 - eddy-current engine brake made by Schenck, 4 - transducer of engine load, 5 - engine speed sensor, 6 - alcohol tank, 7 - gasoline tank

4. Comparison of combustion parameters of gasoline and methanol

Comparison of engine efficiency presented in the Fig. 5 shows that the engine operating on the methanol featured a higher overall efficiency in complete range of change of the loads and rotational speeds. Differences in the efficiency grow together with growth of engine load, and in area of medium and maximal loads, absolute differences amount to 3-5%, what gives relative growth of the efficiency, deciding about operational consumption of energy, in range of 10-16%.

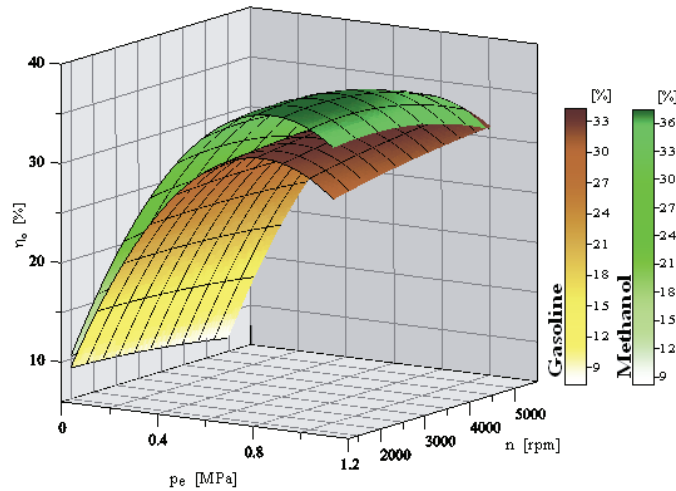

Fig. 5. Comparison of overall efficiency of engine Fiat 1100 MPI fuelled gasoline and metyl alcohol

Comparison of cylinder pressures during combustion for some selected rotational speeds and different engine loads is presented in the Fig. 6. From the comparison is seen, that combustion of the methanol occurs faster, what results in more rapid pressure growth in the initial phase of the process, and consequently in a higher maximal pressures. Such trend is noticeable for all engine loads and all rotational speeds. Especially high differences in course of the pressure are seen at partial engine loads.

Maximal cylinder pressures during combustion of the methanol are reached earlier than in case of the gasoline, while course of the pressure is shifted in direction of the TDC. It can therefore be concluded, that combustion's run of the methanol is more close to the Otto cycle comparing to combustion of the gasoline. Higher dynamics of methanol combustion observed here belongs to a reasons of increased unit power of the engine and its efficiency.

Different trend was seen for a lower engine loads where in case of the methanol, maximal pressures were reached earlier than in case of the gasoline. It can be affected by a lower temperature of the charge before ignition, which is caused by a high value of the heat of vaporization of the methanol.

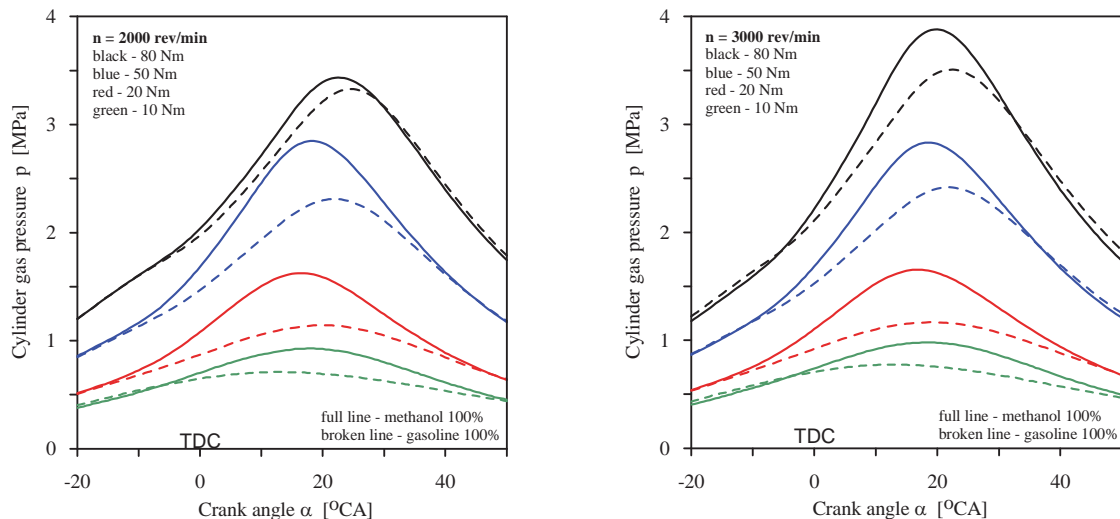

Fig. 6. Comparison of cylinder pressure in function of crank angle for a various engine loads

To better illustrate changes in course of the pressure during combustion of the both fuels, characteristics of the pressure are presented also in spatial system – Fig. 7. With solid line are marked pressure runs of the methanol, while with dotted line corresponding to them runs of the

engine operated on gasoline only. To facilitate the comparison, the diagrams were suitably grouped with colours. Pressure runs obtained in such way confirm above mentioned observations in whole range of change of engine loads

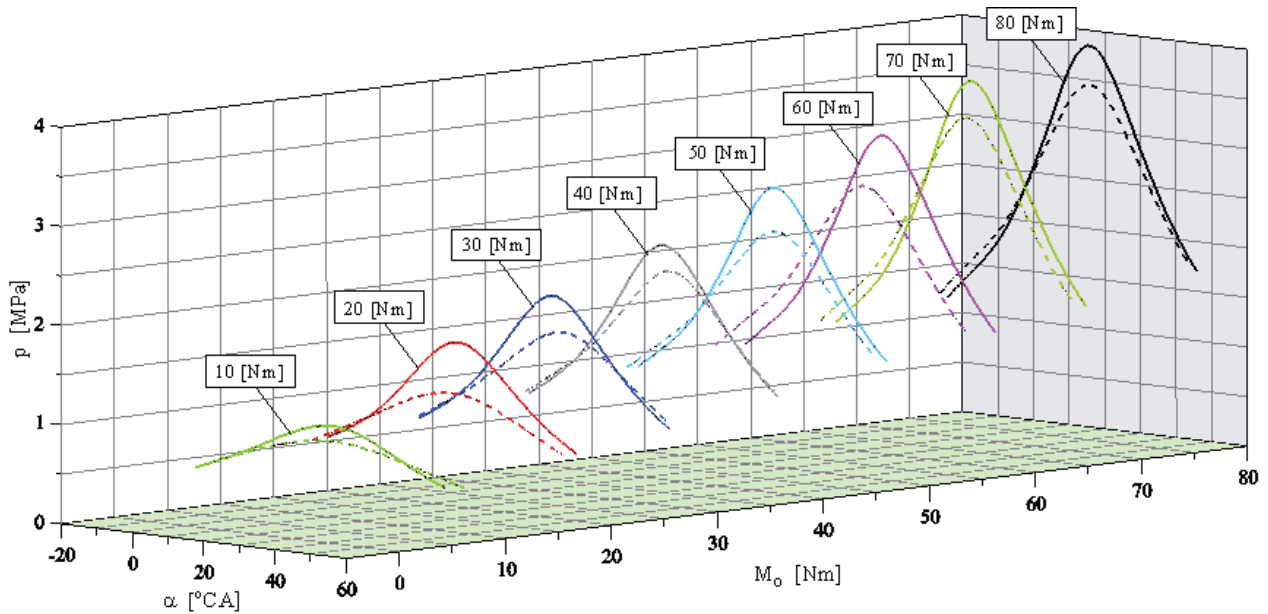

Fig. 7. Comparison of cylinder pressure in function of crank angle for a various engine loads: solid line – methanol, dotted line - gasoline

Higher combustion rate of the methanol results in increased maximal pressures p_{max} , comparing to operation on the gasoline only, in complete range of engine loads (Fig. 8). Average differences in pressure value amount to 0.4-0.5 MPa, whereas character of pressure change, occurring together changing load for the both fuels are similar. It seems that growth of maximal pressure at full engine load, not exceeding 10% of the pressures recorded in case of gasoline fuelling, should not have any effect on durability of the engine fuelled with the alcohol only.

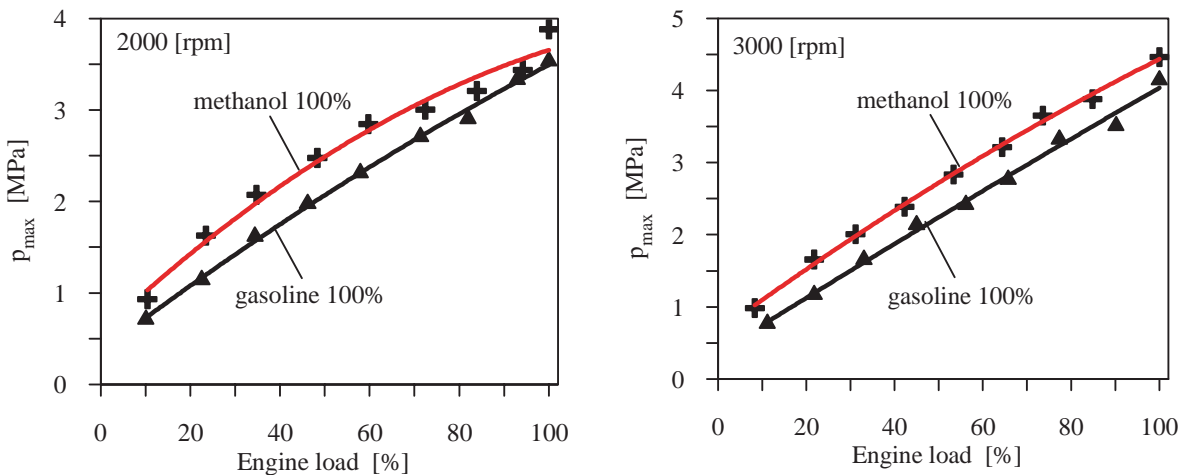

Fig. 8. Comparison of maximal cylinder pressure of engine Fiat 1100 MPI fuelled gasoline and methanol for various loads and engine revolutions

A higher combustion rates of the methanol in the initial phase result in growth of maximal rates of pressure rise $(dp/d\alpha)_{max}$ in complete range of change of engine loads (Fig. 9). Values of the $(dp/d\alpha)_{max}$ do not exceed, however, 0.12 MPa/°CR, and due to it, fuelling with the methanol should not lead to increase of engine noise and increased loading of bearings in crankshaft system.

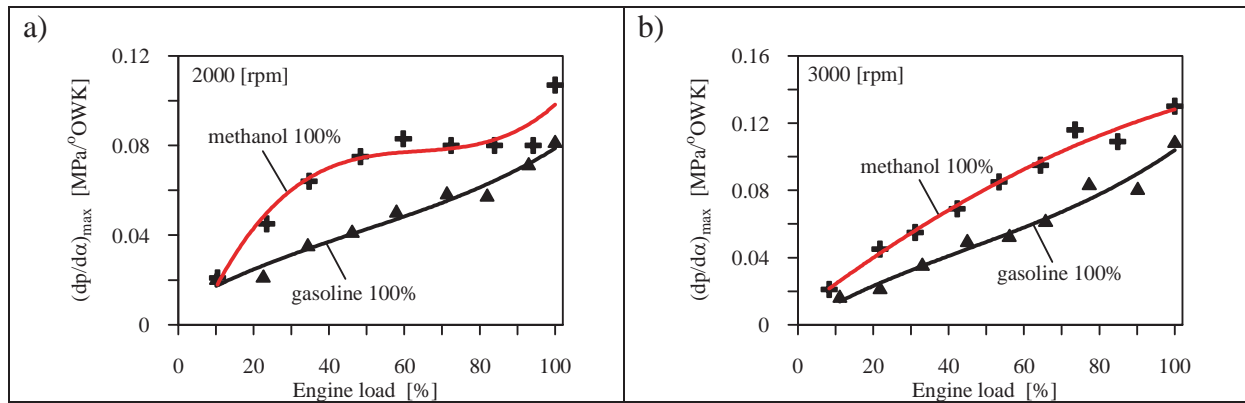

Fig. 9. Comparison of maximal rate of pressure rise in engine Fiat 1100 MPI fuelled gasoline and methanol for various loads and engine revolutions

In the Fig. 10 is presented comparison of the heat release rate during combustion of the both fuels. The comparison was analysed in the interval of maximal combustion dynamics, i.e. for the crankshaft rotation angles of $-20+50^{\circ}\text{CR}$. The comparison was made for different engine loads. From analysis of the curves is seen, that in case of combustion of the methanol are present considerably higher heat release rates as early as in the initial phase of the combustion. In result, maximal values of the $(dQ/d\alpha)_{max}$ for similar engine loads are bigger in case of fuelling with the methanol and occur earlier with respect to the gasoline. Such tendency is noticeable for all engine loads and rotational speeds. The biggest differences were recorded for low engine loads (10 Nm, 20 Nm). Then, maximal heat release rate for the alcohol was nearly two times higher than for the gasoline, and process of heat release itself shows considerable growth of dynamics of the combustion at beginning of the process (tangent line to curve of the heat release rate for the methanol is more steep than the curve for the gasoline). It is also characteristic, that in case of a higher loads, differences in slope of the tangents for the methanol and the gasoline decrease. Instantaneous differences in the heat release rate in case of the methanol are bigger with 20-80% comparing to the gasoline.

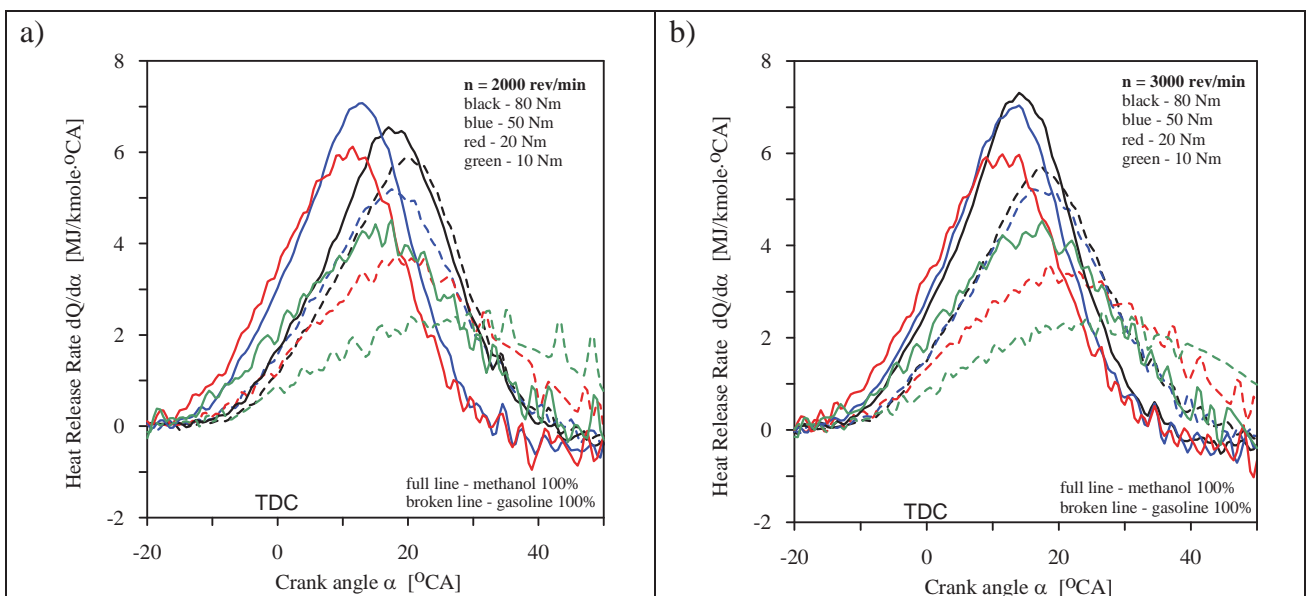

Fig. 10. Comparison of heat release rate by combustion of gasoline and methanol in function crank angle for various loads and engine revolutions

The above observations can be also confirmed by the runs shown in the Fig. 11, where one compared the heat release rates $dQ/d\alpha$ in the spatial system for a selected rotational speeds and all

engine loads, set during the measurements. Similarly to the Fig. 10, with solid line are marked runs of combustion of the methanol, and with the dotted line are marked corresponding to them runs of the engine fuelled with the gasoline.

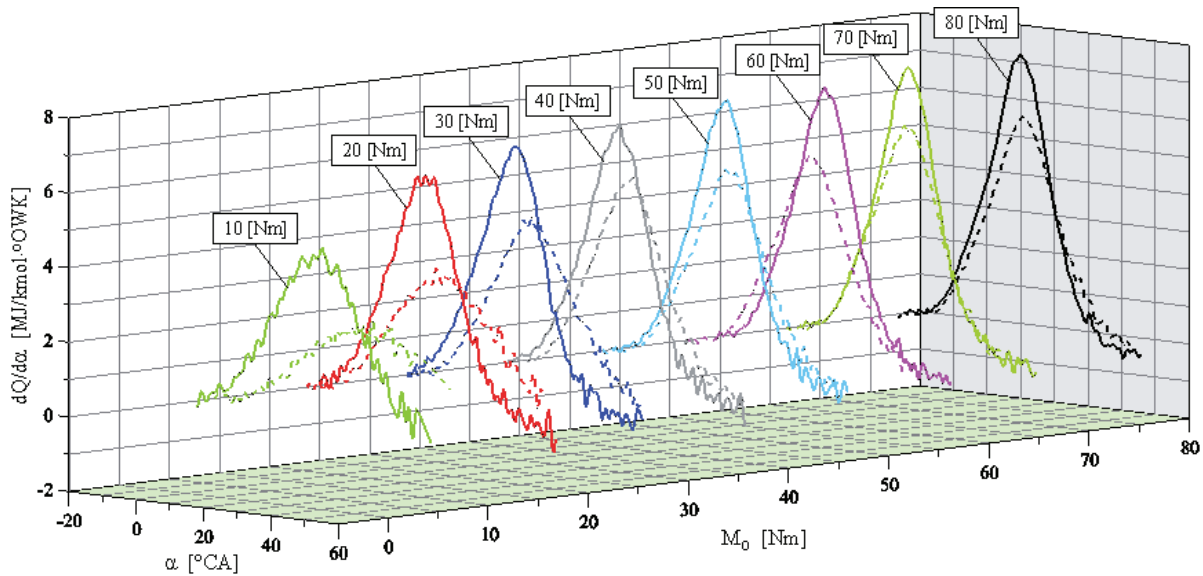

Fig. 11. Comparison of heat release rate in function crank angle: fuelling gasoline and methanol, engine revolution 3000 rpm, solid line – methanol, dotted line - gasoline

Comparison of maximal values of the heat release rate $(dQ/d\alpha)_{max}$ for the both fuels confirm bigger dynamics of combustion of the methanol (Fig. 12). Maximal heat release rates for the methanol are considerably higher than for the gasoline. It concerns complete range of changes of engine loads and rotational speeds. Differences in maximal heat release rate amount to 50-80% with respect to the ones recorded in case of gasoline fuelling.

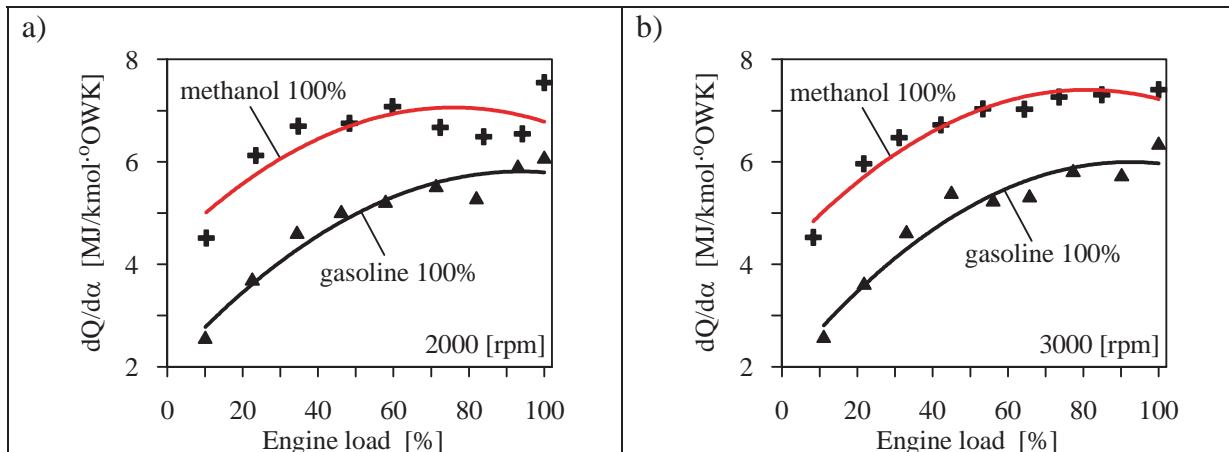

Fig. 12. Comparison of the maximum of heat release rate during combustion in engine Fiat 1100 MPI fuelled gasoline and methanol for various loads and engine revolutions

Diverse run of combustion of the methanol results also in distinct differences in runs of average temperatures of working medium, calculated from the equation of state. With comparable loads of the engine operated at the methanol, there were observed higher temperatures of the working medium, while their maximal values were reached earlier than during combustion of the gasoline. This fact confirms a higher dynamics of combustion of the methanol during initial phases of the process. Differences in discussed values were clear at a higher engine loads and decreased together with reduction of the load.

In the Fig. 13 are shown runs of maximal temperatures of the working medium in the cylinder as a function of engine load during combustion of the gasoline and the methyl alcohol. The greater the engine loads, difference between the temperatures are decreasing, however in case of combustion of the methanol is still observed a tendency to a higher temperatures, comparing to the gasoline. It is worth to be underlined, that in case of combustion of the methanol, as early as for low engine loads one observed a temperatures comparable to the temperatures obtained during combustion of the gasoline and at high engine loads

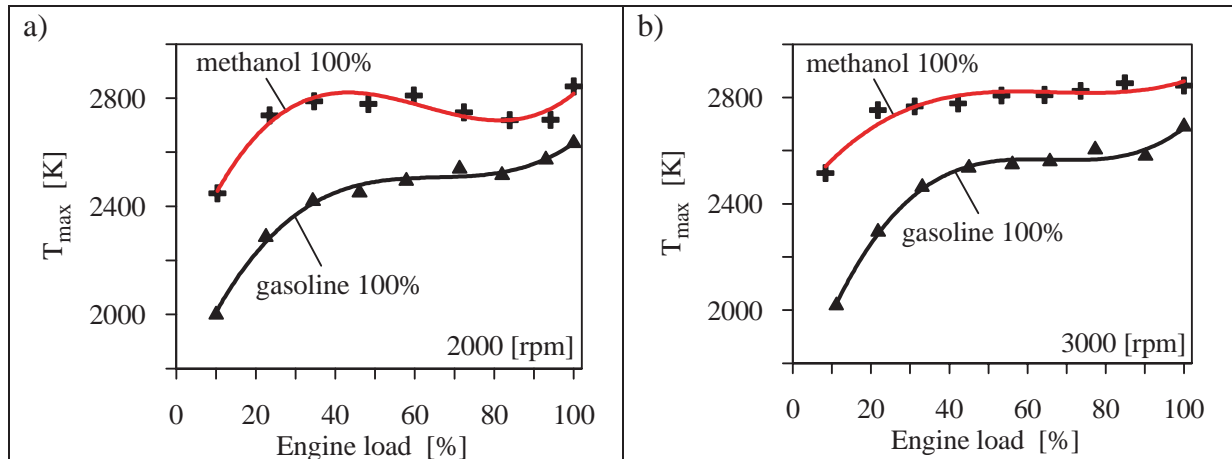

Fig. 13. Comparison of the maximum temperature of the medium during combustion In engine Fiat 1100 MPI powered gasoline and methanol for various loads and engine revolutions

From analysis of the curves shown in the Fig. 13 is seen, that the highest differences in the temperatures are present for low engine loads. For instance, for the engine speed of 3000 rpm, difference of the temperature amounted to about 500 K, and for other investigated speeds the difference changed in scope of 300-450 K. Such differences are decreasing to the value of about 200-250 K as the engine load increases. In case of fuelling with the methanol, even at low engine load, within limits of 20% of the maximal load, the temperatures T_{max} reached value of about 2500 K. A further growth of the load resulted in a slight growth of the temperature only. Change of maximal temperatures for the gasoline shows more distinct tendency to growth together with growth of engine load.

In the Fig. 14 is shown a comparison of total combustion angle of the charge for the methanol and the gasoline. Analysis of the curves points at more quick process of combustion of the methanol, especially at partial engine load. For the lowest engine loads of about 10%, the alcohol is burnt two times faster than the gasoline. As the engine load increases, differences in combustion time of the methanol and the gasoline are getting smaller, and in area of medium engine loads, total angles of combustion of the methanol are smaller only with about $10^{\circ}CR$, what represents approximately 16% of combustion angle of the gasoline. Only in case of the highest engine loads, one can observe comparable angles for the both fuels (especially for the speed of 3000 rpm). From analysis of the curves is also seen, that changes of total combustion angle of the methyl alcohol, as the engine load is changing, are small (for 2000 rpm, the α_{sp} is changing in range of $58-64^{\circ}CR$, and for 3000 rpm in range of $56-62^{\circ}CR$).

From comparison of the combustion angles presented here is seen, that combustion of the gasoline at low engine loads (high degree of air throttling) is very persistent, what results in considerable prolongation of combustion process. Increased degree of natural recirculation of exhaust gases, connected with throttling of the working medium, has a definite influence on this phenomenon. Presence of exhaust gases from a previous cycle reduces rate of mixture oxidation and extends time of the combustion. Effect of the throttling and residuals of the exhaust gases on combustion of the methanol at lower engine loads is considerably lower.

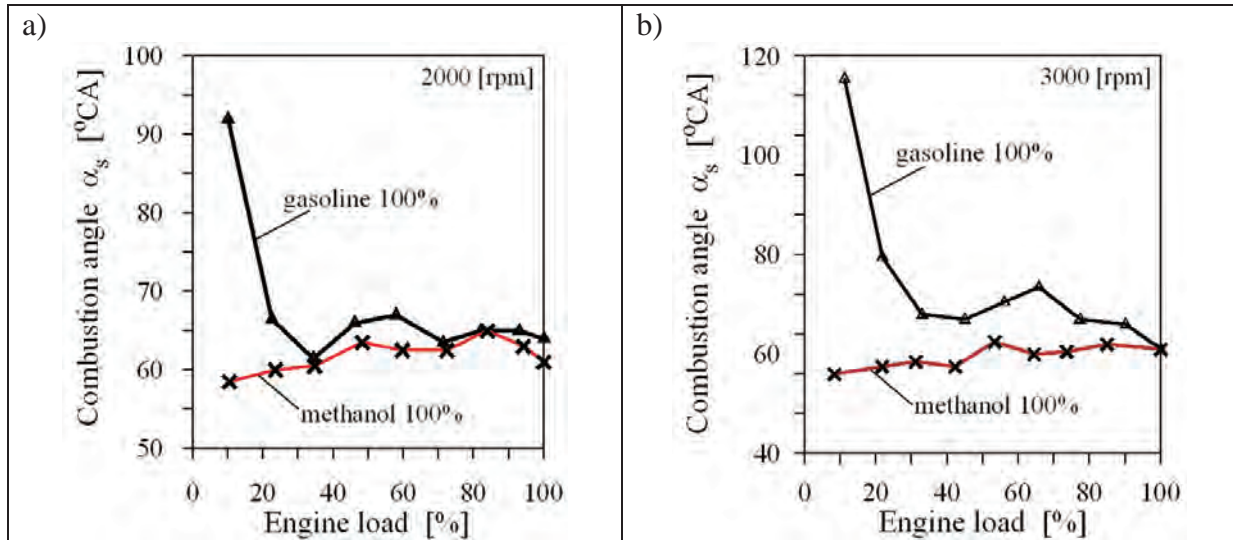

Fig. 14. Comparison of total angle of combustion in engine Fiat 1100 MPI fuelled gasoline and methanol

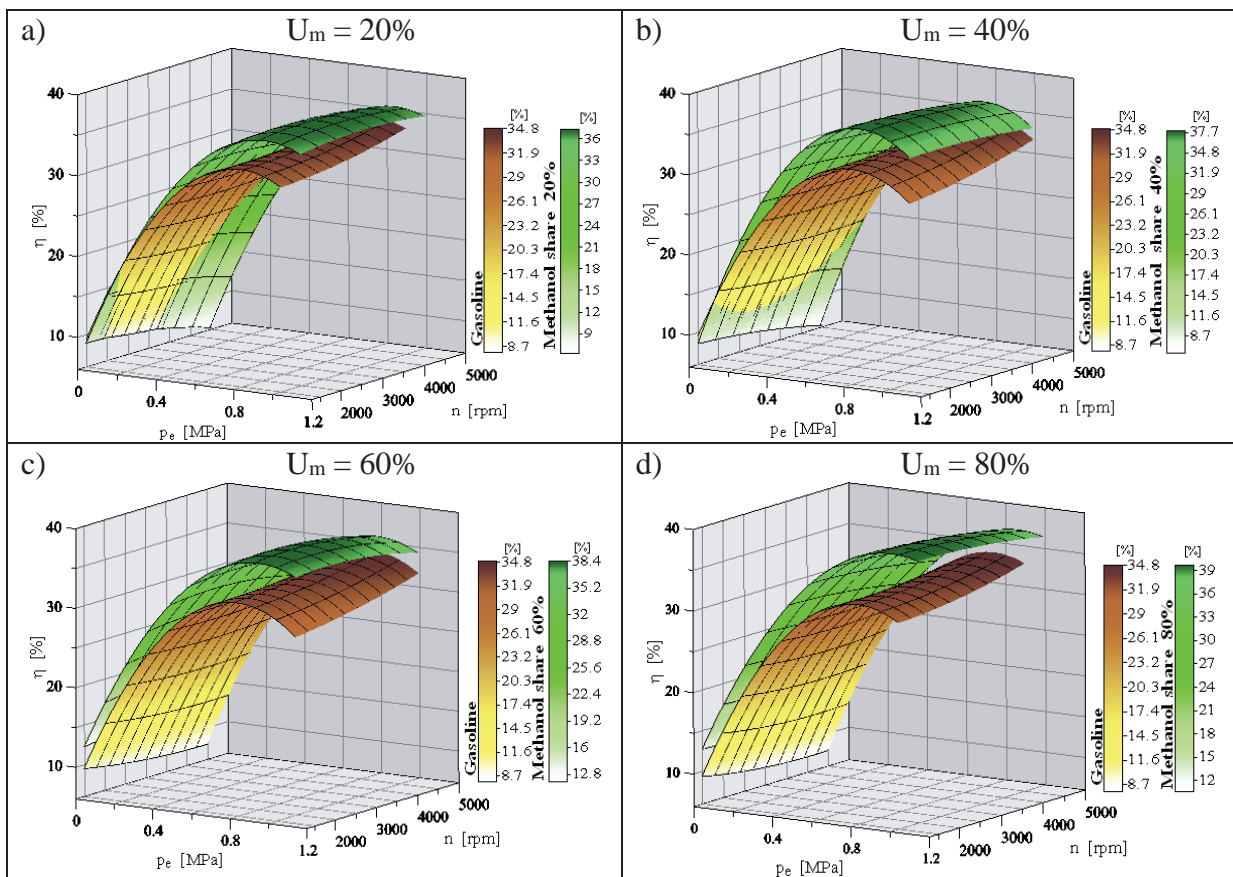

Fig. 15. Comparison of overall efficiency engine Fiat 1100 MPI fuelled gasoline and gasoline-methanol mixture for various methanol share 20%, 40%, 60% and 80%; engine revolutions 1500-5000 rpm

Addition of the methanol in dual fuel supply results in increase of general efficiency, when the engine is operated in dual fuel system, in nearly complete area of change of engine load and rotational speed. From analysis of the curves presented in the Fig. 15 is seen, that differences in the efficiencies are growing together with growth of methanol fraction in the charge and with growth of engine load. In area of average and maximal loads, absolute difference amounts to 2-5%, what gives a relative growth of the efficiency, deciding about operational consumption of energy, within range of 6-16%.

5. Conclusions

On the base of the performed investigations it is possible to draw conclusions of a general character.

1. Addition of the methanol has advantageous effect on run of combustion of the charge in a spark ignition engine, resulting in increase of its overall efficiency. Growth of engine efficiency increases together with growth of methanol fraction and engine load. Absolute growth of overall efficiency amounted to 2-5% and relative growth in range of 6-16%. This significant growth of engine efficiency should lead to reduction of energy consumption during engine operation and improvement of ecological parameters of the engine in form of reduced emission of greenhouse gases, like the CO₂ is.
2. Addition of the methanol results in considerable differences in combustion process with respect to combustion of gasoline mixtures. The combustion occurs more dynamically, especially during initial phase of the process, while total time of the combustion is shorter. To the effects of such changes belong:
 - Higher pressures in the cylinder and higher rates of pressure growth than in case of the gasoline. However, growth of these parameters at full engine load, in relation to traditional fuelling, doesn't exceed 10% and shouldn't have any effect on durability of the engine.
 - Higher maximal heat release rates, causing that in complete process of combustion, the methanol is the fuel more active energetically than the gasoline. This is important at partial engine loads, when the charge incorporates significant amount of residual exhaust gases (growth of natural EGR). Maximal heat release rates were higher on average within limits of 50-80%, and at partial loads nearly two times higher with respect to the gasoline.
 - Higher combustion rate of the methanol is seen during initial phases of the combustion, when considerable differences in run of the pressure in the cylinder and heat release rates, with respect to traditional fuelling, are present. The highest differences were recorded for low engine loads (10 Nm, 20 Nm). It results in a higher smoothness of engine „cycle by cycle” operation, comparing to fuelling with the gasoline.
 - Higher average temperatures of the working medium during combustion are a reason of increased overall efficiency of the engine. It doesn't cause, however, increase of exhaust gases temperature due to shortening of total angle of combustion of the methanol.
 - Smaller angles of total combustion of the charge, what proves about higher average combustion rates of the methanol, especially at partial engine loads. For the lowest engine loads, order of 10% of maximal load, the alcohol is burnt two times faster than the gasoline. Also changes of total combustion angle of the methanol occurring together with change of engine load are small and are included within interval of 56-64°CR.
3. The methanol is such fuel, which even for the lowest engine loads is characterized by considerably higher dynamics of combustion process than the gasoline. Owing to it, in range of low engine loads one recorded the biggest differences between combustion parameters of the gasoline and the methanol.
4. Size of change of combustion parameters depends on fraction of the methanol in total dose of fuel supplied to the engine.

References

- [1] Baczewski, K., Kałdoński, T., *Paliwa do silników o zapłonie iskrowym*, WKiŁ, Warszawa 2005.
- [2] Jakubowski, J., *Silniki samochodowe zasilane paliwami zastępczymi*, WKiŁ, Warszawa 1987.
- [3] Kowalewicz, A., *Metanol jako paliwo do silników spalinowych*, Silniki Spalinowe, Nr 3-4, 1992.

- [4] Kotowski, W., Klimiec, J., Marcjasz-Siemiatkowska, I., *Możliwości wykorzystania metanolu i jego pochodnych jako paliw silnikowych*, Przemysł Chemiczny, Nr 80/1, 2001.
- [5] Larisch, J., Stelmasiak, Z., *Dual Fuelling SI Engine by Mixing Alcohol and Gasoline*, Combustion Engines, No. 3, 2013.
- [6] Lotko, W., *Studium zastosowań paliw alternatywnych w silnikach o zapłonie samoczynnym*, Wyd. Politechniki Radomskiej, 1999.
- [7] Maćkowski, J., *Spalanie paliw naftowych zawierających dodatek etanolu w silnikach o ZI część 1 i 2*, Paliwa, oleje i smary w eksploatacji, Nr 114 i 115, 2003.
- [8] Maćkowski, J., *Wady paliw tlenowych część 2 i 3*, Paliwa, oleje i smary w eksploatacji, Nr 73 i 74, 2000.
- [9] Majoch, A. I., *Etanol w paliwach za i przeciw część 1 i 2*, Paliwa, oleje i smary w eksploatacji, Nr 73 i 74, 2000.
- [10] Merkisz, J., Pielecha, I., *Alternatywne napędy pojazdów*, Wyd. Politechniki Poznańskiej, Poznan 2006.
- [11] Semikow, J., *Studium dwupaliwowego zasilania silnika o zapłonie iskrowym benzyną i alkoholem*, Praca doktorska, ATH Bielsko-Biała 2012.
- [12] Stelmasiak, Z., Larisch, J., Semikow, J., *Preliminary tests on dual fuel spark ignition engine fuelled with methanol and gasoline*, Combustion Engines, No. 3/2008, pp. 24-33, 2008.
- [13] Stelmasiak, Z., Larisch, J., Semikow, J., *Analysis of a chosen combustion parameters of dual fuel SI engine fuelled with alcohol and gasoline*, Combustion Engines, No. 2/2009, pp. 26-36, 2009.
- [14] Stelmasiak, Z., Larisch, J., Semikow, J., *Some aspects of dual fuelling SI engine with gasoline and alcohol*, 12th EAEC European Congress Bratislava EAEC 2009, June 29-July 1, 2009.
- [15] Stelmasiak, Z., Semikow, J., *The possibilities of improvement of spark ignition engine efficiency trough dual fueling of methanol and gasoline*, Combustion Engines, No 3/2010, pp. 59-67, 2010.
- [16] Stelmasiak, Z., Semikow, J., *Niektóre aspekty zasilania paliwami alkoholowymi silników o zapłonie iskrowym*, Logistyka Nr 6, 2011.
- [17] Stelmasiak, Z., *A New Concept of Dual Fuelled SI Engines Run on Gasoline and Alcohol*, The Archives of Transport, Nr 2/2011, pp. 73-85, 2011.
- [18] http://en.wikipedia.org/wiki/Alcohol_fuel#Alcohol_in_Brazil.
- [19] http://pl.wikipedia.org/wiki/%C3%89tienne_Lenoirwww.ciop.pl/10060.
- [20] www.ciop.pl/10060.
- [21] www.en.wikipedia.org/wiki/Common_ethanol_fuel_mixtures.