

THE IDENTIFICATION METHOD OF THE SOURCES OF RADIATED ELECTROMAGNETIC DISTURBANCES ON THE BASIS OF MEASUREMENTS IN THE NEAR-FIELD ZONE

Submitted: 27th August 2021; accepted: 28th December 2021

Krzysztof Trzcinka

DOI: 10.14313/JAMRIS/4-2021/27

Abstract:

The paper presents results of tests of a simple device, consisting in the location of a source of disturbance emission by means of measurements within the near field with manual positioning of the measuring probe. The effectiveness of the source of disturbance location was finally verified by a positive result of the radiated emission tests in the EMC laboratory using a standardised method.

Keywords: *Electromagnetic compatibility, EMC, near electromagnetic field, radiated emission, near-field probes, sources of disturbance*

1. Introduction

The ensuring of electromagnetic compatibility (EMC) of the equipment under test (EUT) means that this equipment is immune to electromagnetic disturbances existing in the environment of its operation [1, 2, 3] and can properly operate there, and that the EUT does not generate and emit to this environment electromagnetic disturbances [1, 4, 5] at such levels, that could disturb proper operation of other equipment working in the surroundings. The emission of electromagnetic disturbances from the EUT may be intended, i.e., may be an element necessary to ensure its functionality. Such emission exists e.g., in the case of equipment with radio communication, such as a mobile phone, where the transmitted radio waves are an intended effect, necessary to ensure wireless communication. Instead, unintended emission of radiated electromagnetic disturbances originates as a side effect of the equipment operation (radiating cables, printed circuit tracks, or conducting elements of the housing).

The level of disturbances generated and emitted from the EUT, conducted and radiated, cannot exceed the limits, which are specified in standards applicable to the tested EUT and its operation environment [1, 4, 5], or in very strict requirements for military equipment [6]. The electromagnetic compatibility plays a big role in the initial stage of the lifecycle, from the development to deployment of electric and electronic devices, because each EUT prior to starting the production should positively pass EMC tests, confirming the compliance with requirements of the EMC directive [1]. Without a positive result of tests, the equipment cannot be placed on the market.

It seldom happens now that even a simple electric device would not comprise active semiconductor components and microprocessor circuits in its structure, which e.g., take care of proper execution of the programmed functions. In addition, an increasingly great degree of the equipment complication and progressing miniaturisation cause that the ensuring of electromagnetic compatibility EMC for the planned device becomes one of more difficult and important tasks for the designer.

Nowadays, it is rare that even a simple electrical device does not have active semiconductor elements and microprocessor systems in its structure, which include they watch over the correct implementation of the programmed functions. In addition, the increasing complexity of devices and the progressive miniaturization make ensuring the EMC electromagnetic compatibility for the designed device one of the more difficult and important tasks for the designer. Therefore, we are looking for effective methods of testing the emission of radiated disturbances with the use of relatively inexpensive equipment.

It should be emphasised, that the limits of emission levels specified in standards [4, 6] are very strict. Therefore, issues with excessive emission radiated during tests in the EMC laboratory using standardised methods occur so often, especially if from the moment of device prototype designing till the tests the ensuring of EMC was neglected by the engineer due to time and budget limitations. It also happens that, despite a serious attitude to the ensuring of EMC for the new devices under development, from the moment of project implementation till the first prototype assembling (application of design recommendations, performance of verification measurements at various project stages), after conducting tests in the EMC laboratory, it turns out that it is necessary to introduce costly changes in the device, mainly due to the excessive radiated emission. High purchase costs of professional testing instruments and limited availability of EMC laboratories as well as high costs of testing cause that the first tests of radiated emission by means of standardised methods are most frequently carried out only on a ready prototype of the device. Major problems occur then, threatening the entire project success. The problems may consist in e.g., design assumptions mistakes, errors in the electronic system, errors in the housing shielding: metal elements of the housing 'by chance' become antennas, also gaps in the shielded housing can take the role of antennas (radiators) [7, 8].

2. Research Problem

In EMC laboratories the emission of radiated electromagnetic disturbances is most frequently measured in SAC (Semi Anechoic Chamber) type chambers by means of an antenna and disturbance receiver, and it is expressed as an amplitude spectrum of electric field E in $\text{dB}\mu\text{V}/\text{m}$ units, in a selected frequency range. During such measurements the antenna, according to document [9], may be situated at a distance of 3, 5, or 10 m from the tested equipment, depending on the chamber sizes. As a result of such measurements an amplitude spectrum of the electric field is obtained, determined as the level of radiated emission, and it is referred to emission limits specified in the standards for the assessment of tested equipment conformity with the standard. The obtained results of radiated emission measurements, in the form of an amplitude spectrum graph within the selected frequency range, provide engineers with general information, whether the EUT meets the requirements of the standard, or whether the standard limits have been exceeded. If the radiated emission limits are exceeded, the information is available on: the level of individual spectrum components, for which frequency ranges the excesses have occurred, and for which orientation of the measuring antenna in space (azimuth, polarisation). The information obtained from such measurements is usually not sufficient to find and remove the main reason for exceeding the limits of radiated emission, although it is useful for further analyses and measurements. Therefore, methods for testing the emission of radiated disturbances are necessary, which allow to illustrate in space the distribution of electromagnetic field intensity around the tested EUT. The identified highest values of component amplitudes of the spectrum prove a close location of the disturbance source in the EUT, which is the information required to introduce dedicated and right design changes, which should result in the reduction of the radiated emission level, generated by the tested equipment.

Methods for measurements of electromagnetic field intensity, carried out in the near zone, feature such properties; depending on the nature of disturbance source and selected probe they allow to measure the electric component of field, E , or magnetic component of field, H . A near electromagnetic field exists at a small distance from the transmitting antenna. In the case of emission radiated from the EUT, that means that the near electromagnetic field exists at a small distance from the EUT (close to radiating elements in the EUT).

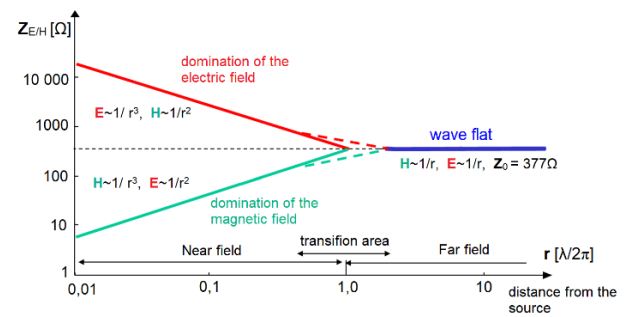

Fig. 1. Nature of electromagnetic field and the distance from the disturbance source [10]

Fig. 1 presents a graph of wave impedance changes versus the distance from the disturbance emission source [10], which illustrates changes of the nature of electromagnetic field with increasing distance from the radiated emission source. Simplifying, the zone of near electromagnetic field is situated at a distance from the source, smaller than r , where:

$$r = \frac{\lambda}{2\pi} \quad (1)$$

$$\lambda = \frac{300}{f} \quad (2)$$

λ – wavelength (m); f – frequency (MHz).

Around the point $r = \lambda/2\pi$ there is a transition area between the near and far field, referred to as the Fresnel zone [11]. In Fig. 1 one can notice, that the field intensity in the near zone goes down with increasing distance from the source, inversely proportionally to the square or third power of the distance, depending on the type of source. In the far-field zone the field intensity diminishes inversely proportionally to the distance. In the near-field zone the electric or magnetic field becomes dominating. If the field source has low impedance, then in the near zone the magnetic component prevails, while at high impedance of the source the electric component prevails. In the measurement methods in the near electric or magnetic field, the measured quantity is the voltage or current of disturbance induced in the measuring probes of the near field E and H (E – electric field, H – magnetic field), which in the spectrum analyser are converted into an amplitude spectrum.

This paper is aimed at presentation of a location method for radiated disturbance sources in the EUT, with manual positioning of the measuring probe in the near-field zone, using an example of a simple tested device EUT, for which negative results of radiated

emission measurements in the EMC laboratory have been obtained. The disturbance source within the tested EUT was searched for by carrying out measurements of electric field E intensity by an E field probe or measurements of magnetic field H intensity by means of an H field probe. The probe is positioned manually in space around the tested EUT. The positions of probe arrangement in space are determined manually, measurements of E or H field intensity are made then by a fixed probe. The effectiveness of this location method of a disturbance source, described further on, has been confirmed by the obtained positive result of radiated emission tests in the EMC laboratory. This method, despite some limitations, in certain cases may be used as one of engineering tools to locate disturbance sources in the tested prototypes of equipment.

Because, in view of frequently occurring problems with excessive emission of electromagnetic disturbances radiated from equipment prototypes, such measurement methods and techniques are being sought, which would be a tool supporting designer engineers. The tool, which will allow to evaluate the emission radiated from the equipment prototype possibly at any stage of product (equipment) development, i.e., single printed circuit boards (PCB), assembled models without housing, a prototype in the target housing, as well as the tool, which will facilitate resolving problems identified during the first emission tests in the EMC laboratory. For PCBs there are already commercially available tools at an acceptable price, but for finished prototypes, which dimensions exceed the size of a cube with a 40 cm side, there are no effective tools and methods, apart from those standardised, used in EMC laboratories. Hence further on in the paper the properties of a method with manual positioning of the measuring probe have been presented, using a practical example.

3. Test Methods for Radiated Emission in a Near Electromagnetic Field – Review of Market Solutions

Methods for measurements of electromagnetic field intensity in the near zone are used for preliminary verification of the equipment condition from the point of view of level of radiated electromagnetic emission and/or location of disturbance sources. The emission of radiated electromagnetic disturbances is understood as the measured level of electric E component of electromagnetic field intensity, expressed in dB μ V/m units. In the case of measuring the magnetic component H of the electromagnetic field, it is converted into the electric component for consistency of units and to facilitate the analysis of signal levels comparison. Measurement methods for the electromagnetic field intensity in the near zone are most frequently used after a previously obtained negative result of tests in the EMC laboratory by a standardised method. Measurement methods in the near zone allow to identify pretty effectively sources of unwanted emission [12, 13, 14], but for simple equipment, with

small dimensions, or printed circuit boards PCB. Measurements in the near zone may be carried out using a spectrum analyser and a set of near-field probes, moving the probes manually or automatically, using commercially available scanners for EMC tests.

3.1. Solutions with Automated Probe Positioning (EMC Scanners)

An instrument of the Detectus company is one of commercial solutions for EMC scanners (Fig. 2), which automatically carries out amplitude measurements of spectrum components of electromagnetic field intensity, using a near-field probe moved automatically at a short distance from the tested object. This solution allows to measure the electromagnetic field intensity from components, cables, PCBs, and entire products in a measuring area of up to 600x400x400mm. The system consists of a numerically controlled robot, moving the measuring probe of E or H field in 3 axes: X-Y-Z. The system is equipped with a set of near-field probes, a spectrum analyser, and a PC with specialised software managing the entire measuring process. During the test the near-field probe is moved by a robotic arm in the selected range (the measuring grid is defined by the user) above the tested object. At the end of measurement, the user obtains a measurement result in the form of a 3D graph of component amplitudes of the spectrum of electromagnetic field intensity, imposed on the tested object, which facilitates the analysis of results. The measurement time with the EMC scanner, depending on the frequency range, selected measuring grid, and the object dimensions, can last even 24 hours.



Fig. 2. EMC scanner – a Detectus RSE series.

Source: <https://astat-emc.pl/produkty/urzadzenia-pomiarowe/skaner-emc/seria-rse/>

Another type of an EMC scanner is the solution offered by the Canadian company EMScan, which offers a family of near-field scanners named EMxpert (Fig. 3). An example of scanner contains a fixed matrix of 1218 magnetic field sensors. The solution is dedicated for measurements in the near field of electromagnetic field intensity from a PCB with maximum dimensions of 31.6x21.8 cm, with resolution of 3.75 mm, and features a high speed of carried out measurements. Paper [15] presents studies using such a

scanner to locate a source of unwanted emission (disturbance source) in a prototype of equipment from the automotive sector. A printed circuit board PCB of a DC-DC converter was the tested equipment. Finally, the effectiveness of disturbance source location and the effectiveness of introduced design changes was verified by the measurement in an SAC type chamber by means of a standardised method (acc. to CISPR 25 standard); a good correlation of results was obtained.

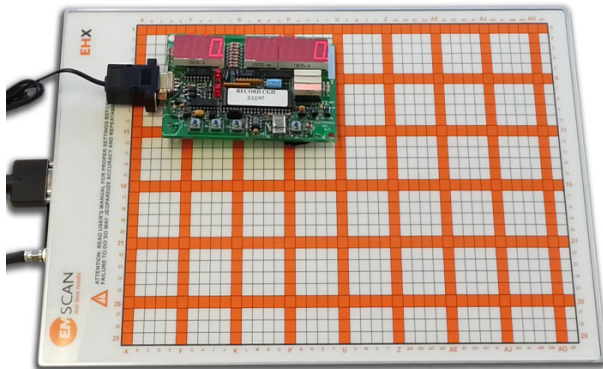

Fig. 3. EMC scanner – an EMScan EMxpert EHX.
Source: <https://www.emcfastpass.com>

3.2. Solutions with Manual Positioning of the Probe

Because of greater affordability of measuring sets, a manual method for probe moving is most frequently used to identify sources of radiated emission. Also, in this solution a spectrum analyser with a set of near-field probes is used. A measuring probe is moved manually above the equipment under test. In this way amplitudes of spectrum components are measured for the signal detected for various areas of the tested equipment. The obtained results of measurements are presented as spectrum characteristics of the measured value in the selected frequency range, for each position of the measuring probe in relation to the tested equipment. A separate characteristic of the emission spectrum is obtained for each position of the probe. For a large number of measuring probe positions a large number of graphs is obtained, resulting in a time-consuming and complicated analysis. On this basis engineers try to identify circuits, fragments, and elements of the equipment housing, which are unwanted sources of electromagnetic radiation, places of maximum levels of signal measured in selected frequency ranges.

The basic drawback of this solution consists in a complicated and time-consuming analysis of results for a large number of measuring points. Moreover, the measurement with a manually moved probe brings about inaccuracies resulting from the need to keep a fixed distance between the probe and the measured element, which is very important for the assessment of the measurement uncertainty. Assuming that sources of unwanted radiated emission have been identified, design changes should be introduced (system changes, shielding, filtering, etc.), to reduce the level of disturbances emitted from the equipment. In the next stage the effectiveness of introduced chang-

es is verified by the next measurements of emission radiated in the near zone at the same positions of the measuring probe. The assessment of effectiveness consists in the comparison of measurement results obtained prior to changes and after the change implementation. The result is satisfactory, if levels of spectrum components of the electromagnetic field intensity decreased after the implementation of design changes, otherwise the measurements should be continued and the introduced design changes verified until the required effect.

The described method of testing, albeit very time-consuming and requiring a complicated analysis of results, in certain cases gives good results. The effectiveness of this method depends on the structured and meticulous attitude to the performance of measurements and analyses, i.e., on the experience of the person carrying out measurements. An example of effective identification, by means of this method, of emission sources of radiated disturbances is presented in results of the research further on in this paper.

4. Research on Radiated Emissions in the Near Electromagnetic Field – a Literature Review

Standardised methods are known for measurements of electromagnetic radiated emission, carried out in the near-field zone. The document IEC TS 61967-3:2014 [16] is an example, defining assessment methods for the electric and magnetic component of electromagnetic field in the near zone for integrated circuits installed on any printed circuit board, PCB. The method allows to map E or H components of the near electromagnetic field in a frequency range of up to 6 GHz. The resolution of measurements depends on dimensions of the measuring probe and the precision of the probe positioning system. Paper [17] presents results of studies on the correlation between the results obtained by the method presented in the document IEC TS 61967-3:2014 [16] and the results of studies obtained with the use of a TEM chamber acc. to IEC 61967-2 [18].

Other widely known methods, based on measurements carried out in the zone of near electromagnetic field, used by engineers to resolve problems with excessive radiated emission or for preliminary assessment of equipment prototypes [11], are not standardised but were published in many scientific papers [11, 12, 19-21]. Paper [11] presents general principles of emission measurements performance in the near-field zone and the usability of such measurements in the engineering practice. This method in the closest way describes the aspects of the method with manual positioning of probes and is similar to the method described in this paper. Instead, paper [12] presents a method for radiated emission measurement in the near zone, using a robotic arm positioning the probe in space around the tested equipment in a repeatable way. These measurements were used to evaluate the shielding. In turn, the method from paper [21] applies to measurements of emission in the near zone, but in relation to integrat-

ed circuits. Methods, which are based on the measurement of electromagnetic field intensity by means of a spectrum analyser with a set of near-field probes and software for the acquisition and visualisation of measurement data, supported additionally with a system for the measuring probe positioning against the tested equipment, are most frequently used.

The knowledge of fundamental principles of measurements for the emission radiated in the zone of near electromagnetic field is necessary to interpret the obtained results properly. Because the results obtained in the near field to a large extent depend on the geometry of emission sources and its properties (domination of E or H field) [11]. The complexity of such measurements performance and interpretation of results causes that there are numerous research studies in order to search for effective methods of radiated emission measurements, carried out in the zone of near electromagnetic fields. These studies focus on the identification (location) of unwanted emission sources [11, 12, 14, 22], and on conversion of results obtained in the near zone into results of emission measurements in the far zone, to enable preliminary assessment of conformity based on the level of electromagnetic emission radiated in the near zone [13], using the emission limits specified in standards and referring to measurements in the far zone.

For example, in paper [12], the radiated emission in the near field was investigated by conducting measurements using a robot and a magnetic field probe. On this basis a radiation model of the disturbance source has been developed, which was used to predict the effectiveness of shielding of equipment enclosures. Considerations included the method of measuring probe calibration and the influence of the entire measuring path (antenna coefficient of the probe, amplifier gain, cables attenuation) on the measurement results. The radiated emission by the tested equipment was modelled based on measurements of the near field, in which the radiation sources were presented by means of equivalent magnetic dipoles.

One of literature examples is the study, in which, based on results of measurements obtained by means of a near-field scanner and equivalent measurements of the far field obtained in a semi-anechoic chamber, a statistic relationship between the intensity of magnetic field in the near field and electric field intensity in the far zone was achieved [13]. Based on statistic measurements the limit for the tested EUT, determined in the standards for the far field, was converted into an equivalent limit in the near field. For such approach statistical measurements were performed for 14 multi-layer PCBs, in which the oscillator frequencies were 10, 25, and 50 MHz. It was found, that the method features a potential as a tool for preliminary EUT assessment in terms of radiated emission requirements. Phase measurements were not used in the research, which resulted in under- or over-estimation of the emission amplitude at certain frequencies. The author indicated the need for further studies for a larger number of PCB samples, as well as using the phase measurements in research.

Other literature examples, where the issue of the effect of estimation or prediction of measurement results of the emission radiated in the near field on the emission radiated in the far field is considered [20, 21, 23, 24], apply mainly to small and simple devices or their fragments (printed circuit boards, radiating integrated circuits, radiating tracks). However, there are no studies, which would try to estimate the results of emission radiated in the near field onto results in the far field, referred to entire and also large and complex EUTs, closed in shielded casings. Partial issues are considered in the mentioned scientific papers. For example, for the case of a radiating micro-strip line there are attempts to predict the radiated emission in the far field based on emission measurements in the near field [20], and to develop numerical models allowing to calculate components of the far-field emission [23]. Another example is the research, related to the estimation of measurement results from the near field onto the far field for integrated circuits [21]. Instead, the approach presented in [13] utilises statistical relationships between the emission in the near and far field with regard to the testing of printed circuit boards PCB. There is also a study [24], in which a method based on modelling of disturbance sources by means of an array of dipoles, using the regularisation techniques, was applied to develop models used for conversion of results of emission measurements from the near field into the far field. The actual measurement results of radiated emission, obtained in the near field and in the far field for integrated circuits, were used to develop this method.

The most recent study [14], related to the measuring systems operating also based on a near-field scanner principle, is directed towards increasing the precision (resolution) of the spatial distribution representation of the near field, for a more precise location of disturbance emission sources in PCB circuits of high packing density.

Apart from methods of scanning in the near electromagnetic field, other location techniques for disturbance sources comprise so-called emission source microscopy (ESM) techniques, in which electromagnetic disturbance sources are located via the measurement of the amplitude and phase of electromagnetic field intensity in the far-field zone, at a distance from the equipment determined as a few wavelengths [25, 26]. These methods are fit for location of electromagnetic disturbance sources in complex and large devices, but the authors emphasise, that they still require further research.

5. Results of Research

The research were aimed at identification of radiated emission sources in the equipment based on measurement results of electric field intensity in the near zone, with the use of manual positioning of the probe. The subject of the research consists of a control and measuring device, used to control parameters of an insulated supply network. Because of the confidential nature of results of the research, carried out for

a commercial customer, the actual view of the device and its full name cannot be used in the description of this study. The EUT-1 name will be used.

a)

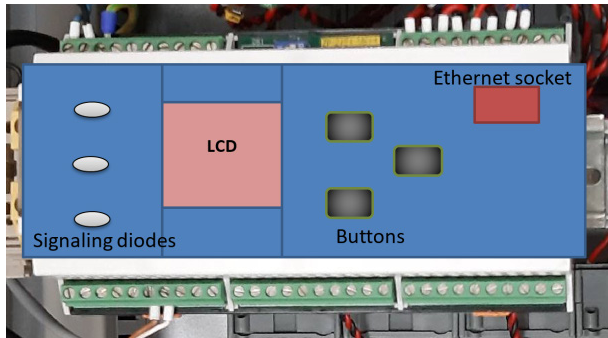

b)

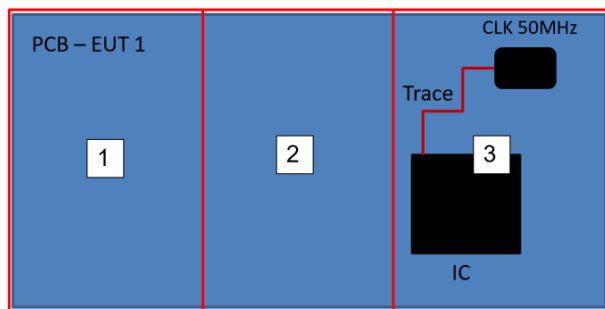

Fig. 4. a) EUT-1 test object – external view of the housing; b) EUT-1 test – a view of PCB, schematic representation of the source of unwanted radiated emission and of the measuring probe positions (1, 2, 3)

5.1. Measurement in the EMC Laboratory – Negative Test Results

Tests of radiated emission with a standardised method in the laboratory in the SAC chamber, at a distance of 3 m from the antenna to the EUT-1, provided the obtaining of radiated disturbance emission in the range of 30–1000 MHz (Fig. 5 and 6). The results were negative, i.e. the limit of radiated emission has been exceeded at both polarisations of the measuring antenna (vertical and horizontal). The negative test results presented in Figs. 5 and 6 are related to measurements of the emission only for the vertical polarisation of the antenna, because the exceeding of limits was the highest in this configuration.

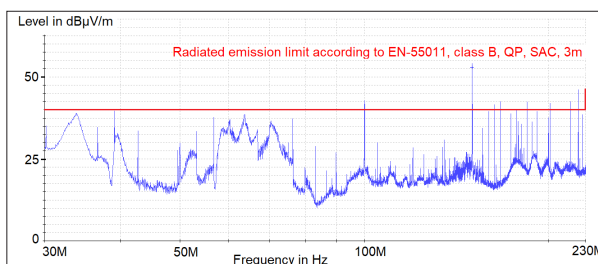

Fig. 5. Measurement results for emission of radiated disturbance of the EUT-1 object, in the range of 30 – 230 MHz, at the vertical polarisation of the antenna. The limit of PN-EN 55011 standard was exceeded highest for class B at frequencies: 100 MHz, 150 MHz, and also 200 MHz and 225 MHz

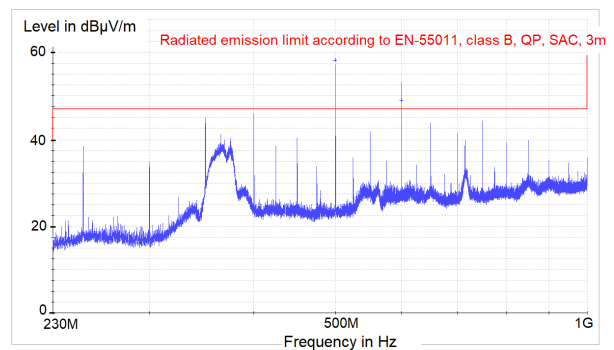

Fig. 6. Measurement results for emission of radiated disturbance of the EUT-1 object, in the range of 230 – 1000 MHz, at the vertical polarisation of the antenna. The limit of PN-EN 55011 standard was exceeded highest for class B at frequencies: 500 MHz and 600 MHz

The analysis of the obtained results has shown, that the exceeding of the limit was observed at the following frequencies:

- Fig. 5, the range of 30–230 MHz: 50 MHz, 100 MHz, 150 MHz, and 200 MHz;
- Fig. 6, the range of 230–1000 MHz: 500 MHz and 600 MHz; high levels, which did not exceed the limit, were observed at the following frequencies: 250 MHz, 300 MHz, 350 MHz, and 400 MHz.

Based on the list of frequencies, at which high amplitude levels of electric field intensity, resulting in exceeding the standard limit, have been observed, it is easy to notice, that the frequency of $f_0 = 50$ MHz was the common divisor, the next cases of limit exceeding are multiplicities of the frequency f_0 , they are harmonics of 50 MHz frequency.

5.2. Measurements in the Near-Field Zone – a Method for the Source of Disturbance Emission Location with Manual Positioning of the Probe

Fig. 7 shows a block diagram of the algorithm presenting the method for disturbance sources location based on measurements in the near-field zone. This is a general method for proceeding, which was used to locate a disturbance source in the tested equipment after obtaining negative results of radiated emission tests by means of the standardised method in the EMC laboratory. Following the algorithm, the source of disturbance was then eliminated and the effectiveness of source location and its elimination was confirmed by measurements in the near-field zone and by laboratory measurements by means of the standardised method.

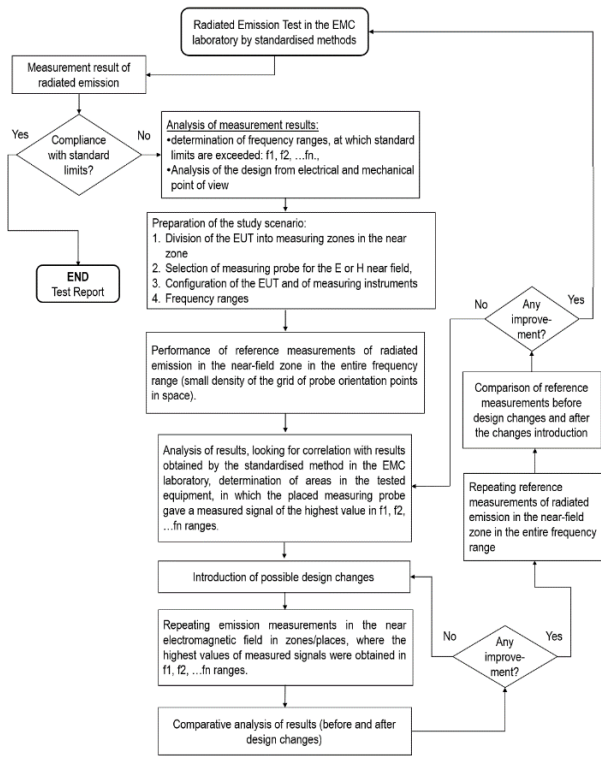

Fig. 7. Block diagram of the algorithm for location of disturbance emission, taking into account the process of disturbance sources elimination through the introduction of design changes

A trial to locate the source of unwanted emission, applying the method of measurements with the use of a spectrum analyser and a set of near-field probes, with the use of the algorithm from Fig. 7, comprised the following sequence of actions:

1. The configuration of the EUT-1 device was reproduced on a test station, like during the tests in the EMC laboratory (in accordance with the standards), maintaining the same mode of operation and arrangement in space.
2. Preliminary experimental measurements were performed in the near-field zone, aimed at choosing the probe type and selection of measurement places, guided by the best sensitivity of the measuring path.

The method to choose a near-field probe:

Based on preliminary experimental measurements, with the working EUT-1 device, it was found that the best effects (the best sensitivity) resulted from the application of an E electric field probe, ball type. Hence further measurements were carried out using this probe.

The selection of measurement places (selection of probe positions grid in relation to the EUT-1):

For the EUT-1 device, due to its small dimensions (165 × 90 × 65) mm excluding cables, based on the experimental measurements a decision was made to perform measurements at a distance of 5 cm at three points above the device, as shown in Fig. 9. During the preliminary experimental measurements, it was found, that it is relatively easy to find such a location of the measuring

probe in relation to the tested equipment, in which there is the maximum level of the measured signal (maximum emission) for the frequency of 150 MHz (frequency at which during the tests in the laboratory the emission limit was maximally exceeded – Fig. 5). Hence it was decided to record results of measurements for further analyses only for three locations of the probe close to the EUT-1. If it is not possible to clearly identify the place with the highest level of disturbance emission, the measuring grid should be compressed.

Configuration of the measuring instruments:

A PMM 9010 measuring receiver, with a module of PMM 9030 extensions, with a set of near-field probes, and a pre-amplifier and a computer with the software for data acquisition, were used for measurements. During the measurements performance the probe was positioned in space in relation to the tested equipment by means of a stand, made of a non-conducting material.

Measurements were carried out by means of a peak value detector (PEAK), at the RBW filter set at 120 kHz (settings like during the measurement in the EMC laboratory, in accordance with the standard); the shape of the spectrum graph was then similar to that obtained by the standardised method during the laboratory measurements, which facilitated the analysis.

3. The selected sphere-type probe of electric field E was used to measure the disturbance emission background on the test station.
4. The EUT-1 device was started and reference measurements were performed in the near the device, in accordance with the determined grid of probe positions (Fig. 4). During the emission measurement at each position the probe was set at a distance of 5 cm from the top point of the housing. An example of measurement results for position 3 of the measuring probe is presented in Fig. 8.
5. The results of measurements recorded in the near zone for 3 determined probe positions were analysed (amplitude spectra were compared for frequencies of the maximum levels occurrence). Figs. 9, 10 and Table 2 present the specification of results. (At this stage, if analyses do not indicate clearly the location of the disturbance source, the grid of measuring probe positions should be compressed).
6. The analysis of recorded results has shown, that the place marked with number 3 in Fig. 4 was the area of the device, at which the maximum amplitude of the radiated emission spectrum was observed. Based on the results of measurements a hypothesis was suggested, that the element or fragment of the circuit, operating at the frequency of 50 MHz, was the main basic source of emission, because the observed high levels of the measured signal were multiplicities of this frequency. The maximum signal amplitudes were registered for 150 MHz and 500 MHz (these are also multiplicities of 50 MHz), hence the frequency

of 50 MHz was chosen for the further analysis, as well as two frequencies, for which the maximum signal amplitude was measured, i.e., 150 MHz and 500 MHz.

For the transparency of the described methodology, further analyses were limited to the frequency range of 30 MHz – 500 MHz, despite the fact that the measurements were carried out in a wider range up to 1 GHz, excluding the (88-110) MHz band, due to a high level of environment disturbances background, caused by the existence of radio station transmitters. Attention should be drawn to the fact, that high emission levels at frequencies above 500 MHz also existed at multiplicities of 50 MHz frequency, but to simplify the analysis, for the needs of this paper, the results from this frequency band were not analysed.

7. The identified area (measurement point 3), with the highest levels of the amplitude of spectrum components of the measured signal at 150 MHz and 500 MHz, was subject to analyses of:
 - the entire device design from the mechanical and electrical point of view,
 - diagrams of electric circuits and tracks in the area of measuring point 3.

As a result of analyses and consultations with the device designer a hypothesis was suggested, that the 50 MHz oscillator was the source of emission, connected e.g., to the microprocessor system and circuits responsible for ensuring communication via the Ethernet interface. In the tested version of the device this interface was not used or software supported. The device expansion with the Ethernet interface was planned by the producer in an unspecified future, to cut the design costs of a new device version. Hence it has turned out that at the moment of testing the elements, being the source of excessive radiated emission, could have been removed via unsoldering, without a loss of device functionality. The 50 MHz oscillator (Fig. 4b) was removed, and the oscillator tracks were short-circuited with a resistor to the system ground.

8. The effect of introduced changes was confirmed by the measurement of radiated emission at the same place and for the same settings and EUT-1 configuration, and the measuring instruments at the measuring point (location) 3. Based on the comparison of levels of component amplitudes of the measured signal spectrum (Fig. 11), the suggested hypothesis was confirmed, related to the frequency of the disturbance source; the source of excessive radiated emission was successfully eliminated. As a result, the device was corrected to the situation of conformity with the standard requirement, which has been finally confirmed in the EMC laboratory. Figs. 12 and 13 present the results.

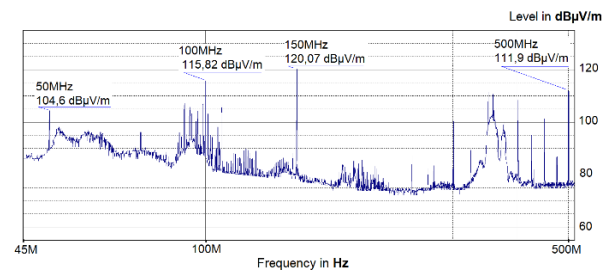

Fig. 8. Results of the reference measurement of disturbance emission using a probe of near field E for position 3 of the probe (immediately after testing in the EMC laboratory, without introduction of design changes)

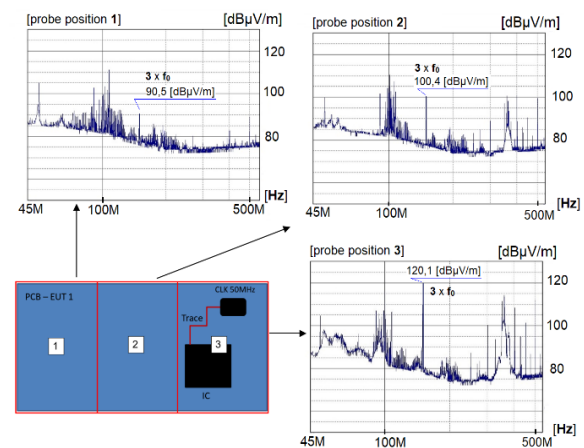

Fig. 9. Recorded characteristics of the intensity spectrum of electric field in the near zone for 3 fixed positions of the probe (3rd harmonic of the oscillator frequency has been marked)

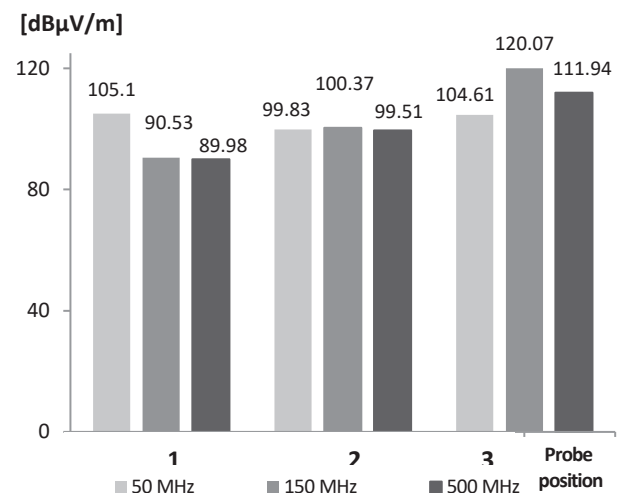

Fig. 10. Comparison of intensity amplitudes of electric field of emitted disturbances for each of three positions of the measuring probe in relation to the EUT-1

Tab. 1. Comparison of measurement results for the electric field intensity, for each of three positions of the measuring probe

Specification of results	Frequencies [MHz]	Intensity amplitude of electric field [dB μ V/m]		
		Point 1	Point 2	Point 3
	50	105.1	99.83	104.61
	150	90.53	100.37	120.07
	500	89.08	99.51	111.94

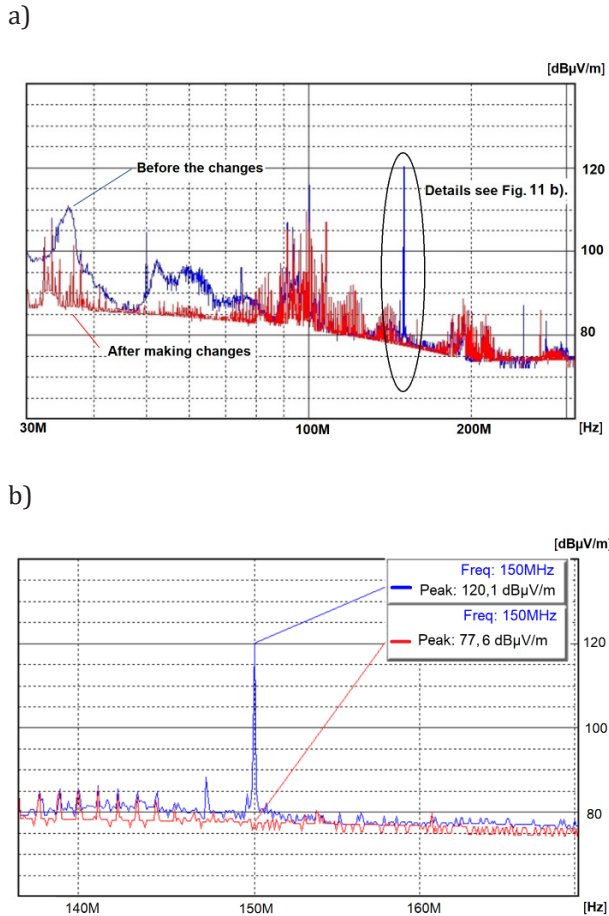

Fig. 11. Results of measurements of radiated disturbance emission in the near zone for the measuring point 3 before design changes and after the changes introduction: a) spectrum within the 30-300 MHz range; b) spectrum for a frequency of 150 MHz

Tab. 2. Assessment of introduced changes effectiveness, based on the measurement of electric field intensity for a frequency of 150 MHz

Method of emission measurements	Intensity amplitude of electric field for 150 MHz before introduction of changes [dB μ V/m]	Intensity amplitude of electric field for 150 MHz after introduction of design changes (source removal) [dB μ V/m]	Difference in the intensity amplitude of electric field before and after introduction of changes for 150 MHz [dB μ V/m]
In the near-field zone (Results based on Fig. 11 b).)	120.1	77.6	42.5
Standardised in the EMC laboratory (Results based on Fig. 5 and 12)	56.5	17	39.5

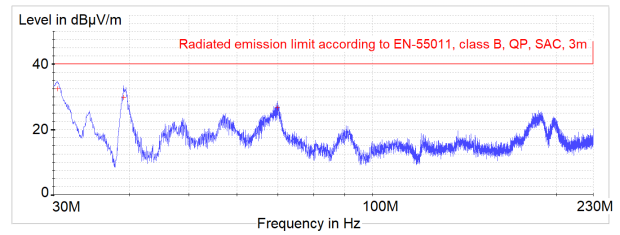

Fig. 12. Results of measurements of radiated disturbance emission in the far zone of the EUT-1 object, in the range of 30–230 MHz, at the vertical polarisation of the antenna – a positive result

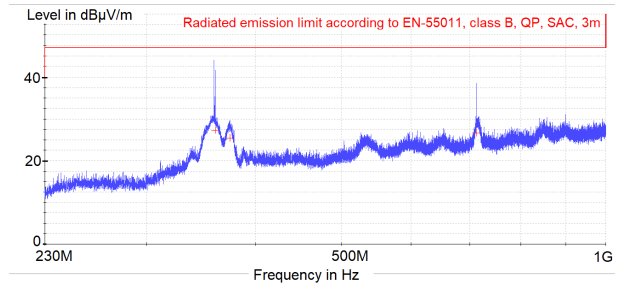

Fig. 13. Results of measurements of radiated disturbance emission in the far zone of the EUT-1 object, in the range of 230–1000 MHz, at the vertical polarisation of the antenna – a positive result

6. Conclusion

The location method for the source of radiated disturbances, applied in the paper, provided good results; its effectiveness was confirmed by experimental tests. The duration of disturbance source location was relatively short, the entire process took a few hours. However, it is necessary to emphasise, that the analysed case was simple, the tested device was small, featuring a simple structure, with one source of unwanted emission.

The difference in the intensity amplitude of electric field at a frequency of 150 MHz before and after the introduction of design changes was 42.5 dB μ V/m for measurements performed in the near-field zone, while for measurements carried out in the laboratory in the far zone, the difference was similar, i.e. 39.5 dB μ V/m (Table 2). Measurements in the near zone were performed above the housing at the place, where the disturbance source was identified.

In this method it is very important to prepare a plan of studies: configuration determination of the station, instruments, and the tested equipment, and then it is important to meticulously observe the made assumptions, because measurements of the near field give only relative results, which may be compared with each other, provided that they are performed at the same settings and conditions before and after the introduction of changes in the EUT [11].

In the measurements of radiated electromagnetic emission in the near-field zone a low level of the electromagnetic background is important in the surroundings of the place of studies, to be capable of effectively carry out measurements and rightly locate the source of disturbances in the tested equipment. Hence it is best to perform the measurements in a shielded room.

The described method of studies is fit for location of disturbance sources in simple and uncomplicated equipment. It does not have limitations in terms of the equipment dimensions, but it has also many drawbacks, such as:

- time-consuming analysis of the results of studies, because for each measuring point at least one graph is obtained; the more configuration cases – the more graphs, hence the analysis of results becomes complicated,
- it is required to strictly stick to the test plan and configuration settings, to ensure repeatability,
- orientation of the probe in space is changed manually, hence the imprecision of the probe orientation in space can result in measurement errors and the distortion of the image of disturbance emission from the device.

Summarising, the location methods for disturbance sources known from the literature, using measurements in the near-field zone for printed circuit boards PCB [13, 14, 15, 17, 20, 23] and for integrated circuits [21], are a good approach leading to the design compliance with the requirements of standards, and later on to a smooth passing through the stage of EMC tests in the laboratory. However, in the case of a more complex equipment, e.g. a mobile robot or another large-size piece of equipment, which contains many various PCBs, cabling etc., this approach does not guarantee success. Even if all PCBs in the process of designing were verified by scanning methods in the near field, to locate and eliminate all disturbance sources, their integration into one multi-function equipment does not give certainty of obtaining a positive results of radiated emission tests in the laboratory. The more complicated the equipment is, the higher is the risk of radiating from the equipment of disturbances with overly high levels, and the identification of such sources is more difficult.

Considering the current state of knowledge and technology, we are short of methods for disturbance sources location and visualisation for the equipment of larger sizes, and featuring a complicated structure (irregular shapes). So it seems, that the construction of a test station for measurements of radiated emis-

sion in the near-field zone, with the idea of operation similar to EMC scanners positioning the measuring probe in 3 perpendicular axes, but intended for equipment of larger sizes, is a right attitude. However, the issue of optimisation in terms of measurements duration remains to be resolved, as well as selection or development of dedicated measuring probes of the near field, to ensure that the process of disturbance sources location and assessment of the radiated emission level, if any, is as effective as possible. Further research will be carried out in this direction.

ACKNOWLEDGEMENTS

This article was written in cooperation with the Faculty of Electrical Engineering of the Białystok University of Technology, Poland, as part of the implementation doctorate.

AUTHOR

Krzysztof Trzcinka – Department of Automation and Robotics, ŁUKASIEWICZ Research Network – Industrial Research Institute for Automation and Measurements PIAP, Warsaw, Poland, e-mail: krzysztof.trzcinka@piap.lukasiewicz.gov.pl.

REFERENCES

- [1] “Directive 2014/30/EU of the European Parliament and of the Council of 26 February 2014 on the harmonisation of the laws of the Member States relating to electromagnetic compatibility (recast)”, <https://eur-lex.europa.eu/legal-content/EN/TXT/PDF/?uri=CELEX:32014L0030&rid=4>. Accessed on: 2022-08-30.
- [2] “EN IEC 61000-6-1:2019 Electromagnetic compatibility (EMC) – Part 6-1: Generic standards – Immunity standard for residential, commercial and light-industrial environments,” <https://standards.iteh.ai/catalog/standards/clc/1a6d-24ca-4ba7-4d0d-a66f-c3d1f226ca0b/en-iec-61000-6-1-2019> Accessed on: 2022-08-30.
- [3] “EN IEC 61000-6-2:2019 Electromagnetic compatibility (EMC) – Part 6-2: Generic standards – Immunity standard for industrial environment,” <https://standards.iteh.ai/catalog/standards/clc/6cfd8fa2-dfaf-459d-8d98-814154d1bfde/en-iec-61000-6-2-2019> Accessed on: 2022-08-30.
- [4] “EN IEC 61000-6-3:2021 Electromagnetic compatibility (EMC) – Part 6-3: Generic standards – Emission standard for equipment in residential environments,” <https://standards.iteh.ai/catalog/standards/clc/a145bf06-c5b5-4e0d-9af3-dd51c414b7f9/en-iec-61000-6-3-2021> Accessed on: 2022-08-30.

- [5] "EN IEC 61000-6-4:2019 Electromagnetic compatibility (EMC) – Part 6-4: Generic standards – Emission standard for industrial environments," <https://standards.iteh.ai/catalog/standards/clc/70229e6a-bc18-4d7d-81f7-96babbfea9ec/en-iec-61000-6-4-2019> Accessed on: 2022-08-30.
- [6] "NO-06-A200:2012 Kompatybilność elektromagnetyczna. Poziomy dopuszczalne emisji ubocznych i odporności na narażenia elektromagnetyczne". (in Polish)
- [7] H. W. Ott, *Noise Reduction Techniques in Electronic Systems, 2nd Edition*, Wiley-Interscience, 1988.
- [8] D. J. Bem, *Anteny i rozchodzenie się fal radiowych*, WNT Warszawa, 1973. (in Polish)
- [9] "CISPR 16-2-3:2016 Specification for radio disturbance and immunity measuring apparatus and methods – Part 2-3: Methods of measurement of disturbances and immunity – Radiated disturbance measurements," <https://standards.iteh.ai/catalog/standards/iec/645f733a-84a9-4ec8-988b-7f1852e118da/cispr-16-2-3-2016> Accessed on: 2022-08-30.
- [10] T. MacNamara, *Handbook of Antennas for EMC*, 2nd ed., Artech House, 2018.
- [11] V. Kraz, "Near-Field Methods of Locating EMI Sources," <https://www.ramayes.com/download/OnFILTER/OnFILTER-Near-Field-Methods-of-Locating-EMI-Sources.pdf>, 1995. Accessed on: 2022-08-30.
- [12] F. Benyoubi, M. Feliachi, Y. Le Bihan, M. Bensetti and L. Pichon, "Implementation of tools for electromagnetic compatibility studies in the near field". In: *2016 International Conference on Electrical Sciences and Technologies in Maghreb (CISTEM)*, 2016, 1–6, 10.1109/CISTEM.2016.8066810.
- [13] K.-Y. See, N. Fang, L.-B. Wang, W. Soh, T. Svimonishvili, M. Oswal, W.-Y. Chang and W.-J. Koh, "An Empirical Approach to Develop Near-Field Limit for Radiated-Emission Compliance Check", *IEEE Transactions on Electromagnetic Compatibility*, vol. 56, no. 3, 2014, 691–698, 10.1109/TEMC.2014.2302003.
- [14] J. Wang, Z. Yan, C. Fu, Z. Ma and J. Liu, "Near-Field Precision Measurement System of High-Density Integrated Module", *IEEE Transactions on Instrumentation and Measurement*, vol. 70, 2021, 1–9, 10.1109/TIM.2021.3078000.
- [15] A.-M. Silaghi, R.-A. Aipu, A. De Sabata and P.-M. Nicolae, "Near-field scan technique for reducing radiated emissions in automotive EMC". In: *2018 IEEE International Symposium on Electromagnetic Compatibility and 2018 IEEE Asia-Pacific Symposium on Electromagnetic Compatibility (EMC/APEMC)*, 2018, 831–836, 10.1109/IEMC.2018.8393897.
- [16] "IEC TS 61967-3:2014 Integrated circuits – Measurement of electromagnetic emissions – Part 3: Measurement of radiated emissions – Surface scan method," <https://standards.iteh.ai/catalog/standards/iec/806cb255-99c1-4aca-ac84-8db6623bf6e0/iec-ts-61967-3-2014> Accessed on: 2022-08-30.
- [17] G.-Y. Cho, J. Jin, H.-B. Park, H. H. Park and C. Hwang, "Assessment of Integrated Circuits Emissions With an Equivalent Dipole-Moment Method", *IEEE Transactions on Electromagnetic Compatibility*, vol. 59, no. 2, 2017, 633–638, 10.1109/TEMC.2016.2633332.
- [18] "EN 61967-2:2005 Integrated circuits – Measurement of electromagnetic emissions, 150 kHz to 1 GHz – Part 2: Measurement of radiated emissions – TEM cell and wideband TEM cell method," <https://standards.iteh.ai/catalog/standards/clc/41042894-a36d-4123-b1cd-1e85986b06ee/en-61967-2-2005> Accessed on: 2022-08-30.
- [19] W. Liu, Z. Yan, J. Wang, Z. Ning and Z. Min, "Ultra-wideband Real-Time Monitoring System Based on Electro-Optical Under-Sampling and Data Acquisition for Near-Field Measurement", *IEEE Transactions on Instrumentation and Measurement*, vol. 69, no. 9, 2020, 6603–6612, 10.1109/TIM.2020.2968755.
- [20] H. Weng, D. G. Beetner and R. E. DuBroff, "Prediction of Radiated Emissions Using Near-Field Measurements", *IEEE Transactions on Electromagnetic Compatibility*, vol. 53, no. 4, 2011, 891–899, 10.1109/TEMC.2011.2141998.
- [21] Z. Yu, J. A. Mix, S. Sajuyigbe, K. P. Slattery and J. Fan, "An Improved Dipole-Moment Model Based on Near-Field Scanning for Characterizing Near-Field Coupling and Far-Field Radiation From an IC", *IEEE Transactions on Electromagnetic Compatibility*, vol. 55, no. 1, 2013, 97–108, 10.1109/TEMC.2012.2207726.
- [22] R. Zaridze, V. Tabatadze, I. Petoiev, D. Kakulia and T. Tchabukiani, "Emission source localization using the method of auxiliary sources". In: *2016 International Symposium on Electromagnetic Compatibility – EMC EUROPE*, 2016, 829–834, 10.1109/EMCEurope.2016.7739167.
- [23] W. Liu, Z. Yan and Z. Min, "The Far-field Estimation for Microstrip Line Based on Near-field Scanning". In: *2018 12th International Symposium on Antennas, Propagation and EM Theory (ISAPE)*, 2018, 1–4, 10.1109/ISAPE.2018.8634064.

- [24] J. Wang, Z. Yan, W. Zhang, T. Kang and M. Zhang, "An effective method of near to far field transformation based on dipoles model". In: *2015 Asia-Pacific Microwave Conference (APMC)*, vol. 3, 2015, 1–3, 10.1109/APMC.2015.7413331.
- [25] S. Yong, S. Yang, L. Zhang, X. Chen, D. J. Pommerenke and V. Khilkevich, "Passive Intermodulation Source Localization Based on Emission Source Microscopy", *IEEE Transactions on Electromagnetic Compatibility*, vol. 62, no. 1, 2020, 266–271, 10.1109/TEM.2019.2938634.
- [26] L. Zhang, V. V. Khilkevich, X. Jiao, X. Li, S. Toor, A. U. Bhoje, K. Koo, D. Pommerenke and J. L. Drewniak, "Sparse Emission Source Microscopy for Rapid Emission Source Imaging", *IEEE Transactions on Electromagnetic Compatibility*, vol. 59, no. 2, 2017, 729–738, 10.1109/TEM.2016.2639526.