

## Dynamic response and reliability analysis of shearer drum cutting performance in coal mining process

Lirong Wan<sup>a</sup>, Kao Jiang<sup>a</sup>, Qingliang Zeng<sup>a,b</sup>, Kuidong Gao<sup>a,\*</sup>

<sup>a</sup>Shandong University of Science and Technology, College of Mechanical and Electrical Engineering, Qingdao 266590, China

<sup>b</sup>Shandong Normal University, College of Information Science and Engineering, Jinan 250358, China

Indexed by:



### Highlights

- Measures to improve shearer stability are proposed from vibration reduction points;
- Shearer hydraulic system is more vulnerable to shocks in the height adjustment stages;
- Proper height adjustment speeds would reduce severe load fluctuations in the process.

### Abstract

Vibration is an inevitable phenomenon in the coal cutting process and severe vibration leads to efficiency loss for cutting equipment. To understand the impact of vibration on cutting equipment and explore the measures to improve the stability, the dynamic response of cutting equipment is analyzed. The shearer drum, which always undertakes coal cutting task and is the vibration source in working process, is established with finite element method and the relations between cutting performance and vibration characteristics are analyzed. Hydraulic system, vulnerable to external shocks, is also established and the dynamic responses of hydraulic piston under different working stages are analyzed. In the frequency domain analysis on cutting load, results show that a vibration signal with higher amplitude appears, which is consistent with the drum vibration frequency. It demonstrates that drum vibration happens under impact load, especially during height adjustment stages. The research provides the methods for vibration reduction and would be helpful for improvement of shearer reliability.

### Keywords

shearer drum; drum vibration; cutting performance; hydraulic system; operation reliability.

This is an open access article under the CC BY license (<https://creativecommons.org/licenses/by/4.0/>) 

## 1. Introduction

Shearer, as shown in Fig. 1, is one of the important fully mechanized mining equipment underground, which mainly undertakes the task of coal cutting. During coal cutting process, vibration is an inevitable phenomenon, especially rock fracture happens during working process [1, 22]. There are many components on shearer, such as transmission gears and conical cutters are vulnerable to failure under shock and vibration as shown in Fig. 2. Meanwhile, failure on those components results in too much difficulty of cutting process and affects the reliability of shearer in return [14, 18]. Therefore, study on the vibration characteristics of shearer drum and the influence of vibration on cutting performance is meaningful for improve the working performance and reliability of shearer.

To improve the cutting performance and working reliability of shearer, many approaches have been proposed recently and most are related with installation angles and arrangement of cutter on shearer drum. In addition, Bołoz [10] found that cutting performance was also related with cutting directions and provided a new way to improve cutting performance. During those research, ground test is one of the

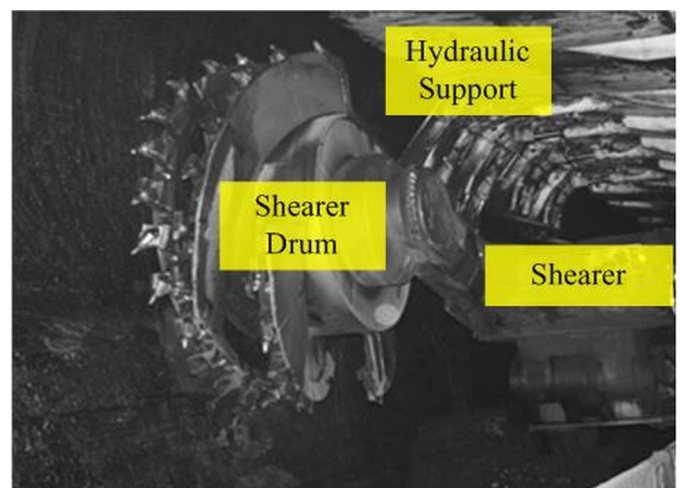

Fig. 1. Coal cutting equipment, named shearer in this paper

(\*) Corresponding author.

E-mail addresses: L. Wan (ORCID: 0000-0002-4279-1598): [lirong.wan@sdust.edu.cn](mailto:lirong.wan@sdust.edu.cn), K. Jiang (ORCID: 0000-0002-4915-2748): [JiangKao93@126.com](mailto:JiangKao93@126.com), Q. Zeng (ORCID: 0000-0002-3842-9107): [qlzeng@sdust.edu.cn](mailto:qlzeng@sdust.edu.cn), K. Gao (ORCID: 0000-0002-8303-5991): [gaokuidong22@163.com](mailto:gaokuidong22@163.com)



Fig. 2. Component failure on shearer

most common approaches to study cutting performance of the drum [13, 17]. However, sometimes the requirements of ground test can not be fully guaranteed and some researchers began to pay attention to simulation method. In this process, results comparison between simulation and experiment methods were made and the accuracy of the results by simulation method was proved by lots of researchers [5, 16, 23]. Mat\_105 in material library is used to simulate the coal and rock cutting process and it is found that the simulation results are in good agreement with the experimental results [12]. Then, results gotten from simulation began to getting recognized and the working performance of cutting equipment under all kinds of possible conditions were explored with simulation method [3, 6, 11, 15]. Chen [2] studied the pore elastic effect in rock cutting process, and gave the influence of rock pore spreading coefficient and cutting speed on rock pore pressure response. Liu [7] innovatively put forward a non-planar tool, triangular diamond tool, and analyzed the influence of caster angle, cutting depth and rotation angle on rock crushing effect. These simulation studies provide reference in the material parameter choice and the contact information between cutter and coal, providing the basis for our simulation research. In fact, shearer drum is indirectly connected with hydraulic cylinder through rocker arm as shown in Fig. 3. Apart from the structural parameters mentioned in the above reference, vibration on cutters and the influence of vibration on cutting performance is rarely studied in those research. Considering the compressibility of fluid in hydraulic cylinder, drum vibration is an inevitable phenomenon during working process. Therefore, it is necessary to conduct the research on drum vibration and its influence on cutting performance.

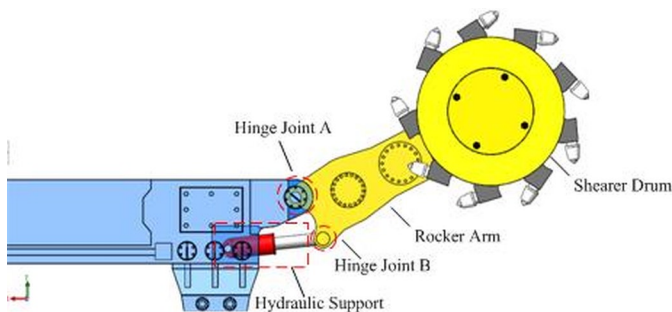

Fig. 3. Diagram of shearer cutting system

To get the vibration characteristics of shearer drum, the hydraulic system for shearer is essential. The dynamic response of hydraulic system has been studied by many researchers under impact load [19,

20, 24]. Zhang [25] got the response characteristics of shearer height adjustment system under constant heavy load condition, and studied the tracking trajectory and its error under the condition of sudden speed and load. Gao [4, 26] applied the cutting force on the free end of the rocker arm and got the dynamic response of hydraulic piston and other components. According to the recent researches, AMESim software has been recognized by researchers and widely used for analysis of hydraulic system.

In order to improve the reliability of shearer operation, this paper analyzed the dynamic response of cutting system and hydraulic system during working process. Firstly, the simulation model of hydraulic system for height adjustment was established. Cutting forces, which were obtained from the finite element model, served as the input signal of hydraulic system and the dynamic characteristics of cylinder piston were obtained. Further, according to the dynamic characteristics of cylinder piston, the cutting load on shearer drum under different dynamic characteristics of piston were simulated with the help of finite element model. Finally, the methods and measures to reduce the impact of cutting load on the shearer reliability were proposed. The research provides measures for vibration reduction and would be helpful for improvement of shearer reliability.

## 2. Method and Numerical Model

### 2.1. AMESim-based simulation model of shearer rocker arm and hydraulic system

According to Fig. 3, the cutting system of shearer mainly consists of hydraulic system, rocker arm and drum. Fig. 4 shows the simplified diagram of cutting system and force analysis could be made with the diagram.

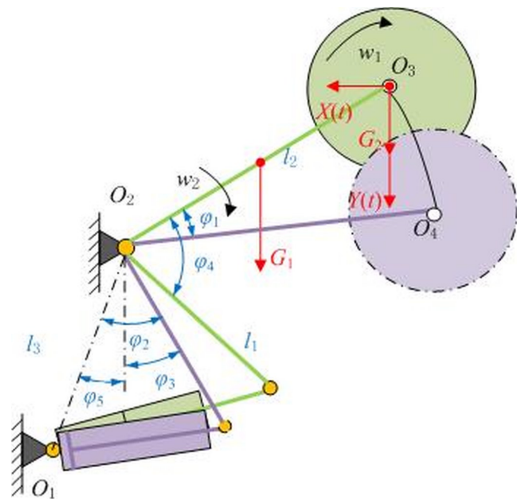

Fig. 4. Schematic diagram of cutting system

Taking the hydraulic piston in hydraulic system as the analysis object and according to force balance equation, the force on hydraulic piston can be gotten:

$$F_e = f(G_1, G_2, X(t), Y(t), M(t)) \quad (1)$$

where,  $G_1, G_2$  are the gravity of rocker arm and shearer drum, kN;  $X(t)$  and  $Y(t)$  are the cutting load on shearer drum in  $X$  and  $Y$  directions, kN;  $M(t)$  is random moment on shearer drum, kN·mm.

To study the dynamic characteristics of hydraulic system of shearer, AMESim-based simulation model of shearer rocker arm and hydraulic system was established and it consisted of hydraulic and mechanical system as shown in Fig. 5. In the figure, the hydraulic system consists of motor (1), pump (2), hydraulic relief valve (3), control signal (4), direction valve (5), bidirectional hydraulic lock (6) and hydraulic

chamber (7). The mechanical system consists of the hinge joint (9), (11) and rocker arm (10). Besides, the hinge joint (9) is responsible for connection of rocker arm and haulage unit of shearer like the hinge joint A shown in Fig. 3. The hinge joint (11) is responsible for connection of rocker arm and hydraulic cylinder like the hinge joint B shown in Fig. 3. The relevant parameters about hydraulic system and rocker arm are shown in Table.1. In addition, according to Eq.1, cutting loads on shearer drum in X and Y directions, which will be gotten with finite element method shown in the Fig. 6, should be input into the system as well.

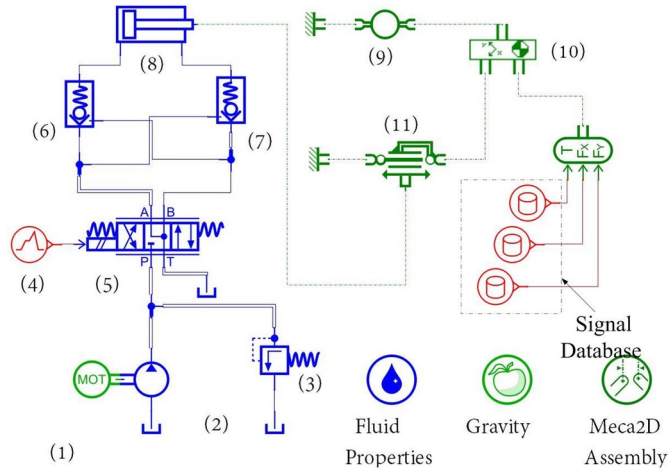

Fig. 5. Mechanism-hydraulics coupling model of drum height adjustment system

Table 1. Structural parameters of mechanism-hydraulics coupling simulation model

Variables	Values	Variables	Values
Pump speed	1470r/min	Length of rocker arm	2620mm
Pump displacement	57L/min	Length of piston stroke	740mm
Relief valve cracking pressure	18MPa	Mass of rocker arm	13295kg
Piston diameter	278mm	Mass of shearer drum	5330kg
Rod diameter	150mm		

## 2.2. Finite element model of drum cutting coal

To study cutting performance of shearer drum in different working stages and get the dynamic response under influence of vibration, the finite element method was applied and the drum cutting coal model was established, as shown in Fig. 6 to simulate coal cutting process. The diameter of shearer drum shown in the figure is 2.2m and it works at the rotation speed of 28 r/min and haulage speed of 2.5 m/min. In the finite element model, the drum finite element model, including blades and cutters, is set as a rigid body, and the coal body is set as brittle damage material. The tensile strength of coal material used in the paper is 2.0 MPa and the uniaxial compressive strength of rock material is 5.0 MPa. In order to make the coal body separated from the working face under the action of cutters, the failure model "ADD\_EROSION" is introduced into coal material model and it is able to simulate different failure modes, such as stress failure, strain failure et al. Meanwhile, elements which attain to its maximum values will be deleted from the finite element model and it is suitable for simulation of coal cutting process. In addition, the moving degree of freedom in Y directions of shearer drum is released in this paper to enable to simulate the vibration characteristics of shearer drum during cutting process.

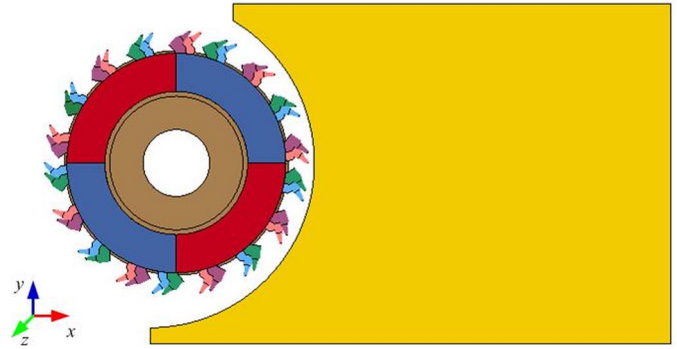

Fig. 6. Finite element model of drum cutting coal

## 3. Numerical simulation for dynamic response of hydraulic system under cutting loads

### 3.1. Possible working conditions during hydraulic system working process

From the equation, the piston in hydraulic cylinder is not only forced by gravity, but also forced by the cutting force in X and Y directions and the random moment on shearer drum  $M(t)$ . In the previous research, the load input into hydraulic system was mostly step signal. The step signal could simulate the characteristics of sudden load, but the frequency characteristics of load were difficult to be comprehensively reflected by step signal. Therefore, the cutting loads shown in Fig. 7, coming from the simulation results with the finite element method shown in Section 2.2, were adopted in this paper as the input signals of hydraulic system and served as the load signals input into the signal database as shown in Fig. 5. In addition, the random moment  $M(t)$  which results from other factors not related with cutting load is not considered and  $M(t)=0 \text{ kN}\cdot\text{mm}$  in this paper.

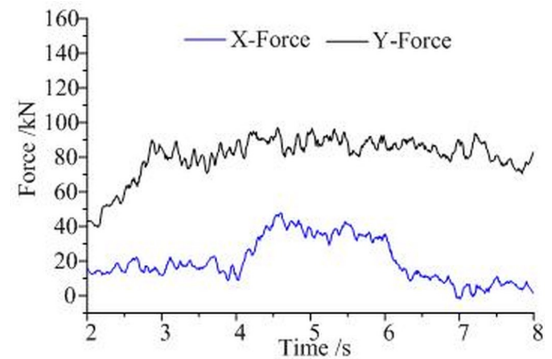

Fig. 7. Cutting load input into hydraulic system

### 3.2. Velocity analysis of piston under different working conditions

Most of the time, shearer drum works at the fixed heights like the working process from  $t_1$  to  $t_2$ , from  $t_3$  to  $t_4$  shown in Fig. 8 and marked with  $T_1$  and  $T_3$ . When roof cutting happens in cutting process, shearer drum might descend its working height like the working process from  $t_2$  to  $t_3$  shown in Fig. 8 and marked with  $T_2$  to avoid rock cutting condition [8, 9, 21]. To get the comprehensive understanding of dynamic response of hydraulic system, the two mentioned working process are discussed and in the paper. In the paper,  $t_1=2\text{s}$ ,  $t_2=4\text{s}$ ,  $t_3=6\text{s}$ ,  $t_4=8\text{s}$ .

From 4~8 seconds, the control current attains to  $-40 \text{ mA}$ , the direction valve (5) works in the left position. During this period, hydraulic oil enters the hydraulic cylinder from pump to push piston to work and shearer drum begins to work at rising or falling height. From the figure, the piston velocity fluctuates largely at the beginning of valve opening. Therefore, the piston velocity varies in a large range at the



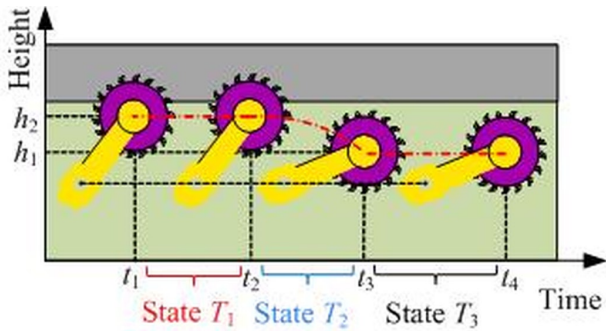

Fig. 8. Possible cutting states of shearer drum in working process

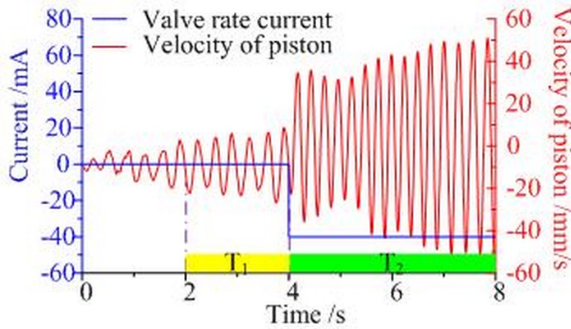

Fig. 9. Piston velocity during different working process

beginning of height adjustment and severe oscillation might happen in this process.

### 3.3. Displacement characteristics of piston and drum under different working conditions

Fig. 10 shows drum and piston displacement characteristics under different cutting load. From the figure, drum and piston displacement is a constant at the first four seconds and drum works without height adjustment. From the fourth seconds, drum begins to work with height adjustment. From the figure, during height adjustment process, the ratio between piston and drum displacement changes and is not a linear any more. To study the displacement characteristics of piston, however, it is difficult to observe the oscillation of piston and shearer drum in Fig. 10 directly, because the amplitude of piston oscillation is not obvious. To get a better view of that, the frequency domain analysis is used in this paper. The drum vibration in different cutting stages ( $T_1$  and  $T_2$ ) are studied with frequency analysis method and the results are shown in Fig. 11.

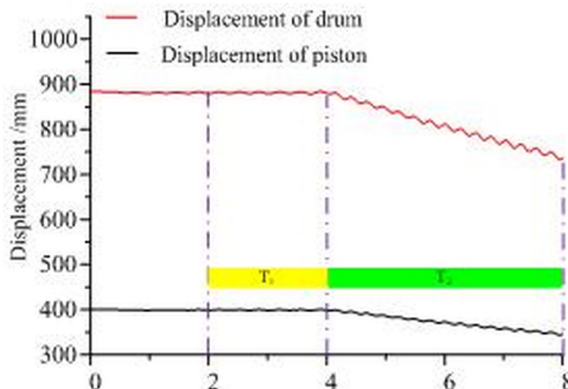

Fig. 10. Displacement characteristics of shearer drum

From Fig. 11, the vibration amplitude of drum is smaller and it is smaller than 2 mm when drum is working without height adjustment. When drum is in the process of height adjustment, the vibration amplitude enlarges and the maximum amplitude of shearer drum is close

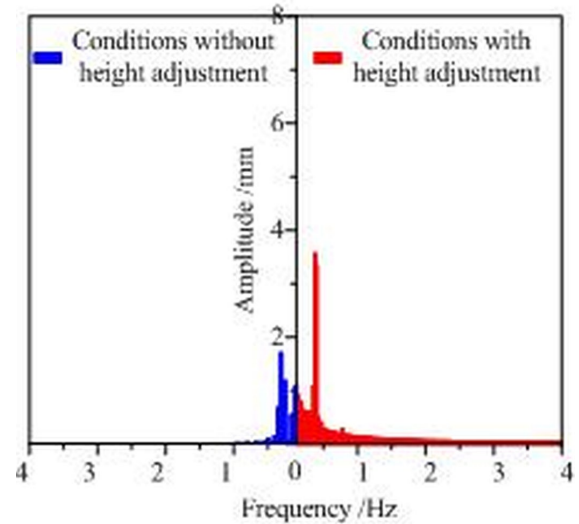

Fig. 11. Amplitude-frequency characteristics of drum vibration

to 4 mm. Therefore, drum vibration during height adjustment process is obvious and the influence of drum vibration on cutting load needs to be studied further.

## 4. Numerical simulation of drum cutting performance under different vibration characteristics

### 4.1. Dynamic cutting performance of shearer drum under different speeds of height adjustment

It is mentioned that drum vibration is much more obvious during height adjustment process in the last part and attention should be paid on the height adjustment to study the dynamic response of shearer drum. The dynamic response of shearer drum under different speeds of height adjustment and the vibration characteristics are studied in the following parts.

(1) Drum height adjustment speed of 200 mm/s

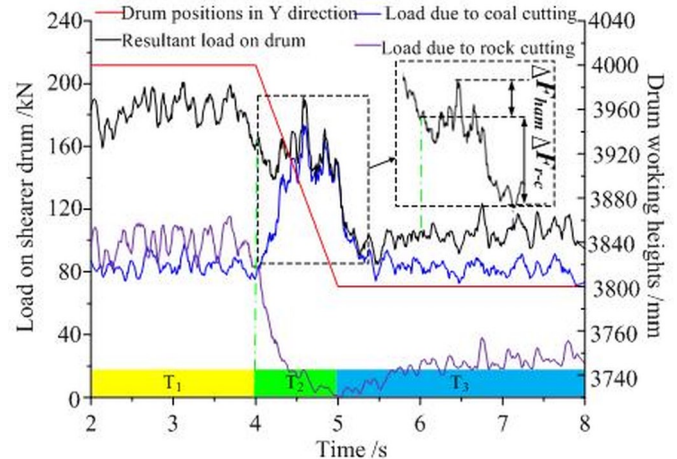

Fig. 12. Cutting load under drum descending speed of 200 mm/s

From the figure, when the drum height adjustment speed reaches 200 mm/s, the cutting load due to coal is about 70 ~ 100 kN before the drum height adjustment; When the drum descends its working height during 4~5 s, the cutting load on drum due to coal rises sharply to 180 kN, the cutting load on drum due to rock decreases about 70 kN and the total force finally increases to 250 kN. Height adjustment increases the total cutting load, instead of decreasing the cutting load in this condition. Therefore, the improper height adjustment speed might increase the cutting load.

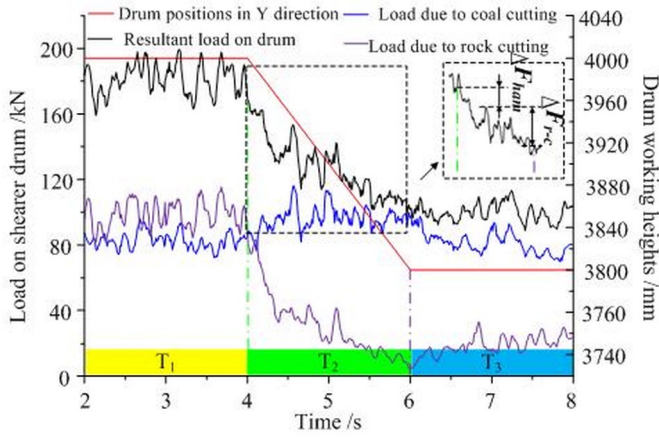

Fig. 13. Cutting load under drum descending speed of 100 mm/s

To evaluate the speed of height adjustment, two kinds of evaluation variables are provided and they are marked with  $\Delta F_{ham}$  and  $\Delta F_{r-c}$ . The variable  $\Delta F_{ham}$  as expressed in Eq. 2 and shown in Fig. 12, is the difference between the cutting load at the beginning of height adjustment and the maximum cutting load during height adjustment process. The variable  $\Delta F_{r-c}$  as expressed in Eq. 3 and shown in Fig. 12, is the difference between the cutting load at the beginning of height adjustment and the cutting load at the end of height adjustment. The variable  $\Delta F_{ham} < 0$  illustrates the cutting load still increases even if rock cutting in the cutting ranges decreases and it also indicates that the speed of height adjustment is not suitable and should be slowed. When the variable  $\Delta F_{ham} > 0$ , it means the cutting loads during height adjustment are less than that before height adjustment and the speed of height adjustment is reasonable. Besides, the larger  $\Delta F_{ham}$  means the speed of height adjustment is suitable and the larger  $\Delta F_{r-c}$  means the greater importance of height adjustment on decreasing the drum cutting loads.

$$\Delta F_{ham} = F_{start} - F_{med\_max} \quad (2)$$

$$\Delta F_{r-c} = F_{start} - F_{final} \quad (3)$$

where  $F_{start}$  is the cutting load on shearer drum at the beginning of height adjustment, kN;  $F_{med\_max}$  is the maximum cutting load on shearer drum during height adjustment process, kN;  $F_{final}$  is the cutting load on shearer drum at the end of height adjustment, kN.

(2) Drum height adjustment speed of 100 and 50 mm/s

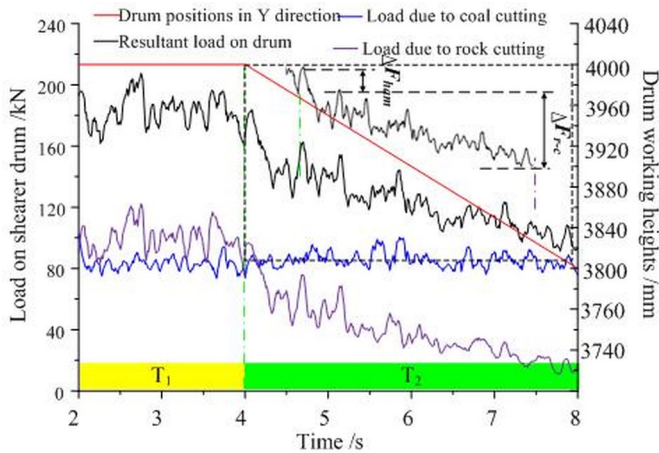

Fig. 14. Cutting load under drum descending speed of 50 mm/s

Similarly, when the speed of drum height adjustment duration descends to 100 mm/s and 50 mm/s, the total cutting load on shearer

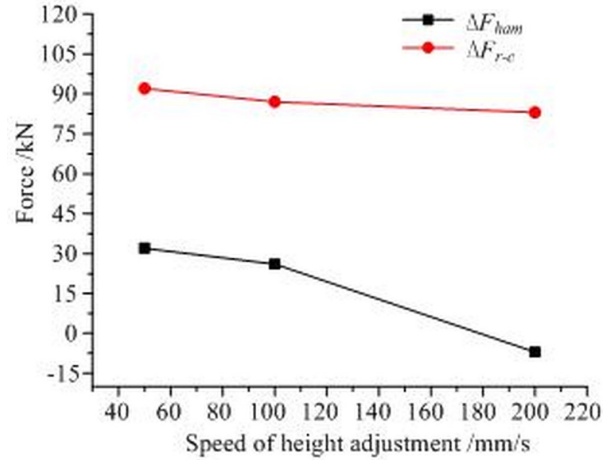

Fig. 15.  $\Delta F_{ham}$  and  $\Delta F_{r-c}$  under different drum descending speeds

drum during height adjustment process is less than that before height adjustment, which are shown in Figs.13 and 14. According to Eqs. 2, 3 and Figs. 12~14, the influence of height adjustment speed on the cutting load can be gotten in Fig. 15. From the figure, when the speed of height adjustment exceeds 200 mm/s,  $\Delta F_{ham} = -7 < 0$ , it means the quick speed of height adjustment process increases the cutting load and it is supported to be slowed. From the figure, when the speeds of height adjustment are 50 and 100 mm/s,  $\Delta F_{ham} > 0$  and it means that those speeds of height adjustment are suitable for working. In addition, for the variable  $\Delta F_{r-c}$ , it varies from 92 kN to 83 kN and little differences on this variable exist under different speeds of height adjustment. It demonstrates that the differences of cutting loads at the beginning and end of height adjustment are less influenced by speed of height adjustment, but the cutting load during height adjustment process is prone to influence by the speed of height adjustment.

#### 4.2. Dynamic cutting performance under drum vibration

According to Fig. 11, it is found that the vibration of drum in Y direction always happens during drum height adjustment process. To study the influence of vibration in Y direction on the cutting performance, the cutting load on shearer drum is obtained under vibration frequency  $f$  and amplitude  $A$  as shown in Fig. 16.

Fig. 16 shows the cutting load on shearer drum and the frequency domain analysis of cutting load. Fig. 16(a) shows cutting load on shearer drum when drum works to cut coal and rock mixed seam at different heights. From 4<sup>th</sup> s, the shearer drum begins to work at the descending states, accompanied with vibration frequency of 4 Hz and amplitude of 6mm. From the figure, the cutting loads on shearer drum perform with regular fluctuation during 4-6 s. Then, frequency domain analysis is made on the cutting loads and the results can be seen in Fig. 16(b). From the figure, the large amplitude of cutting load on shearer drum is mostly on low frequency. Besides, in the frequency domain figure, a local peak occurs at the frequency of 3.98 Hz, which is closer to the vibration frequency of drum displacement in Y direction. The results show that the cutting performance on shearer drum might be influenced by drum vibration in Y direction. Therefore, it can be concluded that the cutting load on shearer drum can be influenced by drum vibration. In addition, the amplitude of cutting load at the frequency closer to the drum vibration frequency will increase obviously. It also can be concluded that drum vibration reduction in Y direction is helpful for decreasing the fluctuation range of cutting load.

#### 5. Conclusion

The models of shearer drum used for coal cutting and the hydraulic system used for height adjustment are established in this paper. The dynamic response of hydraulic system under different working condi-



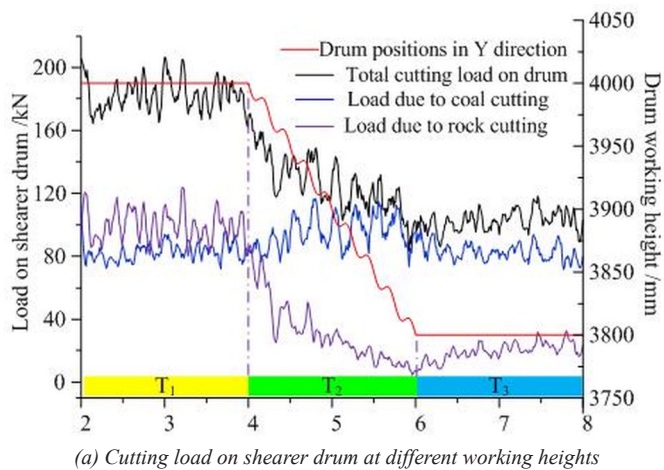

(a) Cutting load on shearer drum at different working heights

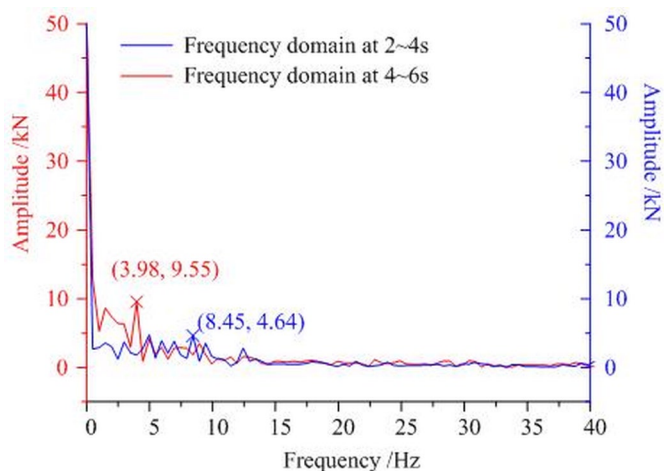

(b) Amplitude and frequency of drum cutting load

Fig. 16. Cutting load characteristics under drum vibration of  $f=4$  Hz,  $A=4$  mm

## Reference

1. Bilgin N, Demircin MA, Copur H, Balci C, Akcin AA. Dominant rock properties affecting the performance of conical picks and the comparison of some experimental and theoretical results. *International Journal of Rock Mechanics & Mining Science* 2006; 43(1): 139-156, <https://doi.org/10.1016/j.ijrmms.2005.04.009>.
2. Chen PJ, Meng M, Ren R, Miska S. Modeling of PDC single cutter – Poroelastic effects in rock cutting process. *Journal of Petroleum Science and Engineering* 2018; 183: e106389, <https://doi.org/10.1016/j.petrol.2019.106389>.
3. Gao MY, Zhang K, Zhou Q, Zhou HF, Liu BL, Zheng GJ. Numerical investigations on the effect of ultra-high cutting speed on the cutting heat and rock-breaking performance of a single cutter, *Journal of Petroleum Science and Engineering* 2020; 190 e107120. <https://doi.org/10.1016/j.petrol.2020.107120>.
4. Gao KD, Meng ZS, Jiang K, Zhang HZ, Zeng QL. Shearer height adjustment based on mechanical-electrical-hydraulic cosimulation. *IEEE Access* 2020; 8: 222064-222076, <https://doi.org/10.1109/ACCESS.2020.3043516>.
5. Jaime MC, Zhou Y, Lin JS. Finite element modeling of rock cutting and its fragmentation process. *International Journal of Rock Mechanics & Mining Sciences* 2015; 80: 137-146, <https://doi.org/10.1016/j.ijrmms.2015.09.004>.
6. Li GH, Wang WJ, Jing ZJ, Zuo LB, Wang FB, Wei Z. Mechanism and numerical analysis of cutting rock and soil by TBM cutting tools. *Tunnelling and underground space technology* 2018; 81: 428-437, <https://doi.org/10.1016/j.tust.2018.08.015>.
7. Liu JX, Zheng HL, Kuang YC, Xie H, Qin C. 3D Numerical Simulation of Rock Cutting of an Innovative Non-Planar Face PDC Cutter and Experimental Verification. *Applied Sciences* 2019; 9(20), e4372, <https://doi.org/10.3390/app9204372>.
8. Li W, Fan QG, Wang YQ, Yang X F. Adaptive height adjusting strategy research of shearer cutting drum. *Acta Montanistica Slovaca* 2011; 16: 114-122, <https://doi.org/10.1111/j.1755-6724.2011.00389.x>.
9. Li W, Luo CX, Hai Y, Fan QG. Memory cutting of adjacent coal seams based on a hidden markov model. *Arabian Journal of Geosciences* 2014; 7: 5051-5060, <https://doi.org/10.1007/s12517-013-1145-5>.
10. Bołoz, L. Interpretation of the results of mechanical rock properties testing with respect to mining methods. *Acta Montanistica Slovaca* 2020; 25(1):81-93, <https://doi.org/10.46544/AMS.v25i1.8>.
11. Menezes PL, Lovell MR, Avdeev IV. Studies on the formation of discontinuous rock fragments during cutting operation. *International Journal of Rock Mechanics & Mining Sciences* 2014; 71 (2014): 131-142, <https://doi.org/10.1016/j.ijrmms.2014.03.019>.
12. Menezes PL. Influence of rock mechanical properties and rake angle on the formation of rock fragments during cutting operation. *International Journal of Advanced Manufacturing Technology* 2017; 90: 127-139, <https://doi.org/10.1007/s00170-016-9342-5>.
13. Pan YC, Liu QS, Peng XX, Liu Q. Full-Scale Linear Cutting Tests to Propose Some Empirical Formulas for TBM Disc Cutter Performance Prediction. *Rock Mechanics & Rock Engineering* 2019; 52: 4763–4783, <https://doi.org/10.1007/s00603-019-01865-x>.

tions are studied and the influence of external loads on the piston velocity are also analyzed. Considering the dynamic response of piston in hydraulic cylinder, the cutting performance of shearer drum under vibration conditions is also obtained and the following conclusions can be gotten in the paper:

1. Under external shocks, the dynamic response of the hydraulic system, represented by the piston, performs with different characteristics. When drum works for coal cutting and without height adjustment, the piston velocity varies slightly around 0mm/s and the piston vibration is also slight in this working conditions. When drum works for cutting and is accompanied with height adjustment, large variation of piston velocity appears at the beginning of height adjustment and piston oscillation gets more serious in this process. The worse working conditions of hydraulic system in height adjustment process requires more attention during reliability design.
2. Under the cutting condition of coal and rock mixed strata, the height adjustment of drum is the most common operations. Generally, longer time spent on drum height adjustment process is helpful to decrease the cutting load, but it does not mean that the longer the spent time is, the more conducive it is to the decrease of the cutting load. In addition, the frequency of cutting load is influenced by the vibration frequency of shearer drum. Reducing the high-frequency vibration on shearer drum is an effective way to reduce fluctuation of cutting load and improve reliability in the process of height adjustment.

## Acknowledgement

This work was supported by the National Natural Science Foundation of China [Grant No. 52174146], the National Natural Science Foundation of China [Grant No. 51674155], the Key Research and Development of Shandong Province (Exploration and Mining of Deep Resources) [Grant No.2019SDZY01].

14. Stachurski W, Midera S, Kruszyński B. Mathematical model describing the course of the process of wear of a hob cutter for various methods of cutting fluid supply. *Eksploracja i Niezawodność – Maintenance and Reliability* 2016; 18 (1): 123–127, <http://dx.doi.org/10.17531/ein.2016.1.16>.
15. Samui P, Kumar R, Kurup P. Determination of Optimum Tool for Efficient Rock Cutting. *Geotechnical and Geological Engineering* 2016; 34: 1257-1265, <https://doi.org/10.1007/s10706-016-0035-5>.
16. Wyk G, Els DNJ, Akdogan G, Bradshaw SM, Sacks N. Discrete element simulation of tribological interactions in rock cutting. *International Journal of Rock Mechanics & Mining Sciences* 2014; 65: 8-19, <https://doi.org/10.1016/j.ijrmms.2013.10.003>.
17. Xiong C, Huang ZW, Yang RY, Sheng M, Shi HZ, Dai XW, Wu XG. Comparative analysis cutting characteristics of stinger PDC cutter and conventional PDC cutter. *Journal of Petroleum Science and Engineering* 2019; 189(1), e106792. <https://doi.org/10.1016/j.petrol.2019.106792>.
18. Yang XW, Zou XF, Zhang S, Chen HY, Wei YJ, Li PF. Dynamic behavior of coal shearer under the influence of multiple factor in slant-cutting conditions. *Scientific Reports* 2021; 11(1), e18447. <https://doi.org/10.1038/s41589-021-98049-x>.
19. Yang Y, Fan H, Ma PC. Research on dynamic characteristics for longwall shearer cutting transmission system with varying cutting speed. *International Journal of Precision Engineering and Manufacturing* 2017; 18: 1131–1138, <https://doi.org/10.1007/s12541-017-0132-2>.
20. Yang SY, Ou YB, Guo Y, Wu XM. Analysis and optimization of the working parameters of the impact mechanism of hydraulic rock drill based on a numerical simulation. *International Journal of Precision Engineering & Manufacturing* 2017; 18: 971-977, <https://doi.org/10.1007/s12541-017-0114-4>.
21. Yang DL, Li JP, Wang YX, Jiang HX. Analysis on vertical steering vibration of drum shearer cutting part. *Journal of Central South University*. 2018; 25: 2722-2732, <https://doi.org/10.1007/s11771-018-3949-7>.
22. Zhang ZH, Gao WL, Li KP, Li BJ. Numerical simulation of rock mass blasting using particle flow code and particle expansion loading algorithm. *Simulation Modelling Practice and Theory* 2020; 104(2), e102119. <https://doi.org/10.1016/j.simpat.2020.102119>.
23. Zhen C, Mao S, Li GS, Huang ZW, Wu XG, Zhu ZP. Imaging the formation process of cuttings: Characteristics of cuttings and mechanical specific energy in single PDC cutter tests. *Journal of Petroleum Science and Engineering* 2018; 171: 854-862, <https://doi.org/10.1016/j.petrol.2018.07.083>.
24. Zhou W. Simulation of Hydraulic System Faults for Marine Machinery Based on AMESim. *Journal of Coastal Research* 2019; 94(S1): 357-361, <https://doi.org/10.2112/SI94-073.1>.
25. Zhang YF. Research on trajectory tracking and its control strategies of drum shearer. Zhejiang University, 2014.03.19.
26. Zeng QL, Gao KD, Zhang HZ, Jiang SB, Jiang K. Vibration analysis of shearer cutting system using mechanical hydraulic collaboration simulation. *Proceedings of the Institution of Mechanical Engineers Part K Journal of Multi-body Dynamics* 2017; 231: 708-725, <https://doi.org/10.1177/1464419317705986>.