

A numerical model to simulate the motion of a lifesaving module during its launching from the ship's stern ramp

Paweł Dymarski, Ph. D.,
Czesław Dymarski, Prof.,
Gdansk University of Technology, Poland

ABSTRACT

The article presents a numerical model of object motion in six degrees of freedom (DoF) which is intended to be used to simulate 3D motion of a lifesaving module during its launching from a ship using a stern ramp in rough sea. The model, of relatively high complexity, takes into account both the motion of the ship on water in changing sea conditions, and the relative motion of the ramp with respect to the ship.

The motion of the ramp changes and strongly depends on its constructional and geometrical parameters. The presented model takes into account the displacement of the submerged part of the ramp, as well as its damping in the water and the interaction with the module moving on it. The results of test simulation of a module launching from the ship in still water are included.

Keywords: lifeboat; rescue boat launch; innovation; launch ramp aft; computational model for simulation

INTRODUCTION

Protection and saving of human life is one of basic issues which have to be solved by designers of marine watercraft, especially passenger ships.

Lifesaving systems used for evacuating people, especially from large passenger ships, have evolved starting from relatively simple open lifeboats and life rafts, up to presently used unsinkable closed lifeboats revealing high strength and fire resistance which are extended overboard and launched at a controlled speed using board davits. These davits provide opportunity to extend the boat overboard and launch it even in the lack of power supply, and at ship's heel reaching 20° and trim up to 10° using gravitational forces or the collected energy.

An important aspect to be taken in to account when developing these systems is the tendency to shorten the evacuation time and, at the same time, to secure safe and relatively comfortable getting people into the lifesaving units.

This problem was part of the European project entitled SAFECRAFTS pt. "Safe Abandoning of Ships - improvement of current Life Saving Appliances Systems", which was carried out in years 2004-2009 and the participant of which was the Faculty of Ocean Engineering and Ship Technology, Gdansk University of Technology.

Within the framework of this project a number of concepts of novel LSA systems were developed, as described in [1, 2, 3] and [4]. In two of those systems which look most interesting an open stern ramp/door was applied, over which the launched

lifesaving boats or other watercraft units with people inside are to slide into water in the direction opposite to the motion of the endangered ship.

One of these systems, shown in Fig. 1 and described in detail in [3], provides opportunities for fast and safe evacuation of people using only gravitational forces. The rescued people get simultaneously into all lifeboats situated on different decks, after which a system is started to lower the boats at a controlled speed. When the boats reach the level of the ship's slip, they are hooked in, one by one, and freely slide down the ramp to the water.

In the second system, developed by Fassmer and schematically shown in Fig. 2, the watercraft units are situated in rows on the lower deck. People get into all boats at the same time, and then using the already accumulated energy, or that delivered from an additional electric power generator, the boats are rolled to the ramp from which they slide down to the water. The ramp has a three-segment structure, but when the boats with people slide down to water all three segments are blocked in a one-plane position. The last ramp segment has an air tank connected to its bottom side, to allow the ramp to adapt its inclination angle to the water level overboard, which changes mainly to ship rolling or pitching motions and sea waving. The largest ramp inclination angle is 36°.

In these two systems the most dynamic and dangerous evacuation stage is sliding the unit with people down the ramp in rough sea. It is worth stressing, however, that modelling this evacuation stage in the second system is more difficult and general, and that is why it was selected for realisation as one of separate research tasks in the abovementioned project.

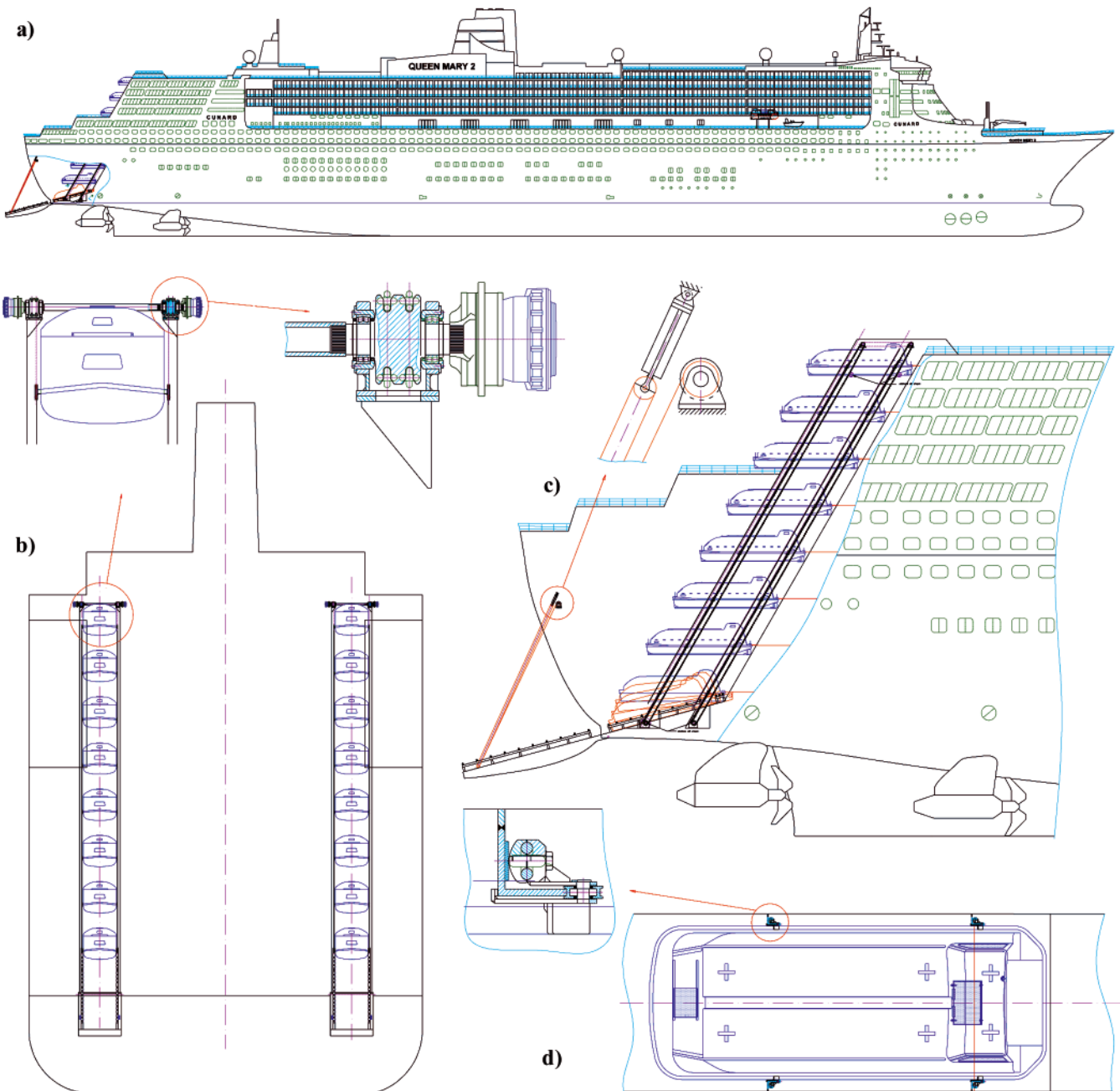

Fig. 1. Simplified picture of the system for evaluating people from the ship: **a)** side view of the ship, **b)** stern view of the ship with driving system components, **c)** shaft cross section with chain hoists and boats, and the visible ramp/door opening mechanism, **d)** top view of the boat placed on the hoist in the shaft with marked nodes of its seating on the hoist [3]

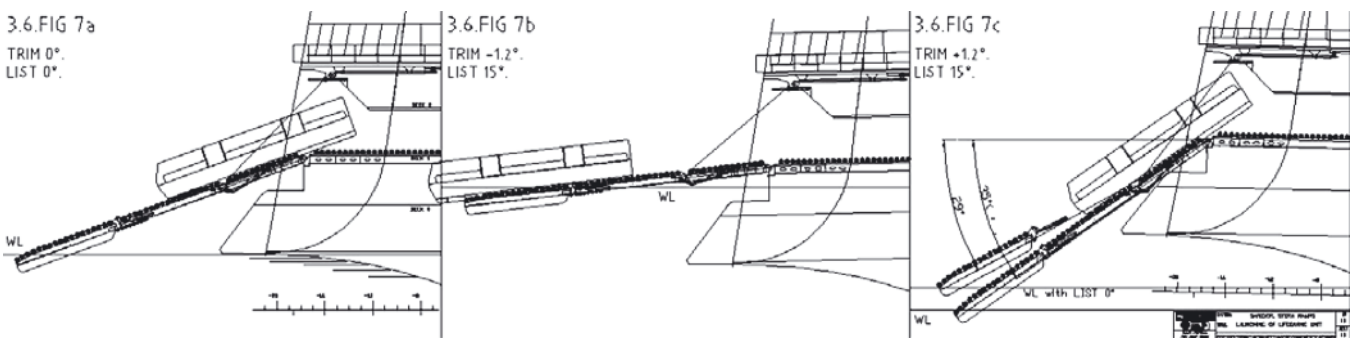

Fig. 2. Launching of the Lifesaving Unit [4]

The article presents the results of the task performed by the authors which concerned developing a comprehensive mathematical model to simulate the motion of the lifesaving

module during its launching from the ship in rough sea. Moreover, the results of test calculations of sample launching from the ship in still water are included.

DESCRIPTION OF THE MATHEMATICAL MODEL

In the numerical model developed by the authors, the moving basic system components, i.e. the lifesaving module and the moving part of the ramp, are generally modelled as rigid bodies with six degrees of freedom which are subject to: the action of the environment (water, wind, etc.), the reactions of neighbouring objects (collisions), and the reactions coming from motion constraints, such as the hinges which fix the moving part of the ramp, for instance.

Moreover, certain elements (nodes) are identified in the lifesaving module which are used for detecting collisions with other objects (mainly the ramp). The interaction is of the elastic-plastic nature with damping. Node deformations are not permanent – at the next collision their positions with respect to the local coordinate system of the module remain unchanged.

Equations of motion of the rigid body (lifesaving module)

The motion of a rigid body in six degrees of freedom is described by the following equations:

$$\begin{aligned} \frac{d}{dt}(MV_x) &= F_x \\ \frac{d}{dt}(MV_y) &= F_y \\ \frac{d}{dt}(MV_z) &= F_z \end{aligned} \quad (1)$$

$$\begin{aligned} I_{xx_0} \frac{d}{dt} \omega_{x_0} - (I_{yy_0} - I_{zz_0}) \omega_{y_0} \omega_{z_0} &= M_{x_0} \\ I_{yy_0} \frac{d}{dt} \omega_{y_0} - (I_{zz_0} - I_{xx_0}) \omega_{z_0} \omega_{x_0} &= M_{y_0} \\ I_{zz_0} \frac{d}{dt} \omega_{z_0} - (I_{xx_0} - I_{yy_0}) \omega_{x_0} \omega_{y_0} &= M_{z_0} \end{aligned} \quad (2)$$

where:

- M – mass of the rigid body,
- V_x, V_y, V_z – velocity vector components,
- $\omega_{x_0}, \omega_{y_0}, \omega_{z_0}$ – angular velocity components,
- $I_{xx_0}, I_{yy_0}, I_{zz_0}$ – moment of inertia with respect to $x_0, y_0,$ and z_0 axis, respectively
- F_x, F_y, F_z – force vector components,
- M_x, M_y, M_z – moment vector components,
- x, y, z – coordinates of the “absolute” coordinate system,
- x_0, y_0, z_0 – coordinates of the local coordinate system fixed to the rigid body.

The forces and moments are calculated as the sum of the reactions of interactions with other objects, the hydrodynamic reactions, and the gravitational forces.

Hydrostatic and hydrodynamic forces

The hydrostatic forces were calculated as the integrals of the hydrostatic pressure function over the hull surface. The hull of the module and the pontoon plating were modelled using tetragonal panels. In order to calculate the hydrodynamic forces

acting on partially submerged panels, the submerged part and the centre of the panel were to be calculated. The hydrostatic force acting on a single panel was calculated from the formula:

$$\mathbf{R}_{HS} = -\rho_w g h_C S_{wet} \mathbf{n} \quad (3)$$

where:

- \mathbf{R}_{HS} – hydrostatic force vector,
- ρ_w – water density,
- g – acceleration of gravity
- h_C – submersion of the centre of the wetted panel surface
- S_{wet} – area of the wetted panel part
- \mathbf{n} – unit normal vector

The hydrodynamic reaction is the sum of friction and pressure forces. The total reaction is the sum of the hydrodynamic forces acting on all panels. For a single panel the hydrodynamic force is calculated using the formula:

$$\mathbf{R}_{HD} = -\frac{1}{2} \rho_w (C_F V_T V_T + C_P V_n V_n) S_{wet} \quad (4)$$

where:

- \mathbf{R}_{HD} – hydrodynamic resistance,
- C_F, C_P – friction and pressure force coefficients,
- V_T, V_n, V_T, V_n – tangent and normal velocity vectors and absolute values, respectively.

Definitions of V_T and V_n , are given as:

$$V_n = (\mathbf{V} \cdot \mathbf{n}); V_T = V - V_n \quad (5)$$

Hydrostatic and hydrodynamic forces

On the hull of the lifesaving module, a number of bearing nodes were selected which were the objects of action of the ramp pressure forces. The value of the force is defined by the linear function of the crossing distance of the basic (undeformed) ramp surface by the bearing node, see Fig. 3 and Fig. 4. This linear function has been limited by the maximal pressure reaction, introduced to limit modelling of the bearing pressure forces to the range observed in real conditions (for instance due to the loss of stability of the structure, or exceeding the yield point).

The pressure force acting on the ramp:

$$\mathbf{R}_N = \begin{cases} E_{spr} \Delta s \mathbf{n} & \Delta s \leq s_{spr} \\ \mathbf{R}_{MAX} \mathbf{n} & \Delta s > s_{spr} \end{cases} \quad (6)$$

where:

- E_{spr} – modulus of elasticity [N/m],
- Δs – distance between the bearing node and the base surface, see Fig. 2,
- \mathbf{n} – unit normal vector

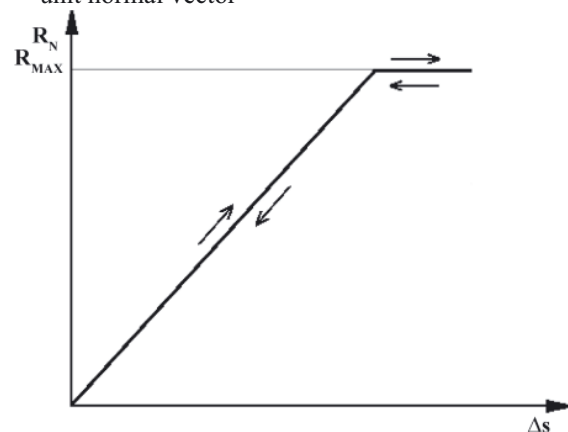

Fig. 3. Normal force characteristic

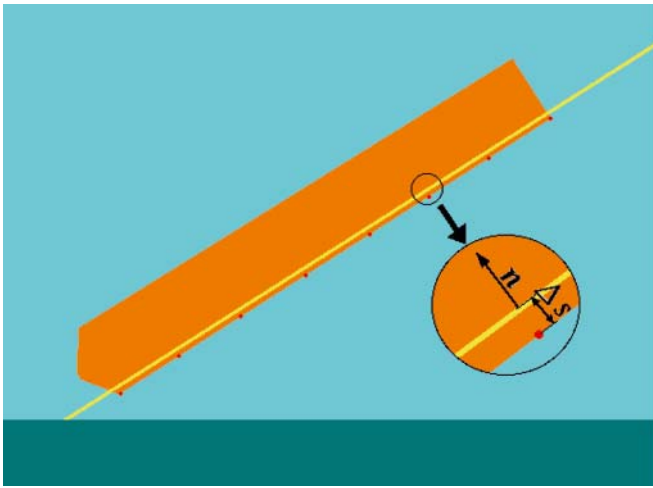

Fig. 4. Definition of unit normal vector n and pressure distance A_s

The rolling friction force is a linear function of the pressure force.

$$\mathbf{F}_T = \mu |\mathbf{R}_N| \mathbf{e}_T \quad (7)$$

where:

- μ – rolling friction coefficient,
- \mathbf{e}_T – unit tangential vector

The unit tangential vector is defined as:

$$\mathbf{e}_T = \frac{\mathbf{V}_T}{|\mathbf{V}_T|} \quad (8)$$

The damping force was introduced to the model to take into account the kinetic energy loss caused by the deformation of constructional elements of the module during collision. It was assumed in the presented model that the damping force is proportional to the normal velocity during collision:

$$\mathbf{R}_{DAMP} = -c_{DAMP} \mathbf{V}_N \quad (9)$$

where:

- c_{DAMP} – damping coefficient,
- \mathbf{V}_N – normal velocity vector.

The added water mass

When a body submerged in water is subject to the action of a force, its inertia seems to be larger than in air. This effect is caused by the presence of the so called added water mass (added mass), i.e. the additional mass of water which moves together with the submerged body. When this body is accelerated the added water is also subject to acceleration, therefore in order to reach a given speed more momentum is to be delivered than when the body is not submerged.

The equation of linear motion in 1D can be written in the form:

$$\frac{d}{dt} [(M + m)V] = F \quad (10)$$

where:

- V – velocity,
- F – force,
- M – mass of submerged body,
- m – added water mass.

For 3D motion, the added mass is different for each of main directions, therefore the equations of linear motion for a 3D case can be written as:

$$\begin{aligned} \frac{d}{dt} [(M + A_{11})V_x] &= F_x \\ \frac{d}{dt} [(M + A_{22})V_y] &= F_y \\ \frac{d}{dt} [(M + A_{33})V_z] &= F_z \end{aligned} \quad (11)$$

where:

- A_{11}, A_{22}, A_{33} – added masses in x, y and z direction, respectively.

A similar phenomenon can be observed for the angular motion. A submerged body which is subject to the action of a moment reveals larger moments of inertia than the same body when taken out of water. For a simple 1D case of angular motion, the dynamic equation has the form:

$$\frac{d}{dt} [(I_{zz} + A_{44})\omega_z] = M_z \quad (12)$$

The angular motion in 3D is described by the equations:

$$\begin{aligned} (I_{xx_0} + A_{44}) \frac{d}{dt} \omega_{x_0} + \\ - [(I_{yy_0} + A_{55}) - (I_{zz_0} + A_{66})] \omega_{y_0} \omega_{z_0} &= M_{x_0} \\ (I_{yy_0} + A_{55}) \frac{d}{dt} \omega_{y_0} + \\ - [(I_{zz_0} + A_{66}) - (I_{xx_0} + A_{44})] \omega_{z_0} \omega_{x_0} &= M_{y_0} \\ (I_{zz_0} + A_{66}) \frac{d}{dt} \omega_{z_0} + \\ - [(I_{xx_0} + A_{44}) - (I_{yy_0} + A_{55})] \omega_{x_0} \omega_{y_0} &= M_{z_0} \end{aligned} \quad (13)$$

where:

- A_{44}, A_{55}, A_{66} – added masses (or added moments of inertia) for the rotation around the x_0, y_0 and z_0 axis, respectively.

The complete equations of angular motion in three degrees of freedom also include terms with A_{ij} , where $i \neq j$. The above presented form is simplified.

The presence of the added masses considerably affects characteristics of motion of a ship (or boat). Oscillation time periods are longer, while ship responses to external excitations are smaller, and its behaviour on wave is more stable. In the case of boat launching, the added water masses remarkably reduce its velocity. The phenomenon of slamming can be interpreted as non-elastic collision with masses of water which “join” the hull of the boat (module), thus becoming its added mass. When the added mass is taken into account in the equations, then the hydrodynamic force caused by slamming can be calculated using the formula given in [2].

Modelling of the slamming phenomenon

As written above, the slamming phenomenon can be described and its intensity can be predicted using the concept of added water mass. An elementary problem of calculating hydrodynamic reactions caused by body collision with water surface (in 2D) was discussed by von Karman in 1929. The mathematical model used by the authors bases on the concept of added mass changes.

Let us consider the following case: a body with mass M and added mass m bumps into water with velocity V_0 , while the velocity of water is V_w . After a short time interval Δt the added water mass increases to $m + \Delta m$ and the velocity of the body changes to V_1 . Based on the principle of conservation of momentum we have:

$$(M + m)V_0 + \Delta m V_w = (M + m + \Delta m)V_1 \quad (14)$$

The velocity of the body V_1 after the time Δt is:

$$V_1 = \frac{(M + m)V_0 + \Delta m V_w}{M + m + \Delta m} \quad (15)$$

and the average body acceleration in this interval:

$$a = \frac{V_1 - V_0}{\Delta t} \quad (16)$$

Hence, the average hydrodynamic reaction caused by the slamming effect is:

$$F_{slam} = Ma \quad (17)$$

It was assumed in the adopted model that the amount of the added mass is proportional to the area of the wetted surface S_{wet} :

$$m(S_{wet}) = \frac{S_{wet}}{S_0} m_0 \quad (18)$$

where:

- $m S_{wet}$ – instantaneous added mass,
- S_0 – wetted body surface in hydrodynamic equilibrium state,
- m_0 – added mass in the state of hydrostatic equilibrium (when $S_{wet} = S_0$)

The forces generated by slamming are calculated in successive time steps within the given time interval Δt .

The above scheme refers to the 1D case, but it can be easily extended to 3D cases.

When the boat has some angular velocity before it comes into contact with water, then the hydrodynamic reaction caused by the moment of inertia of added masses appears. Applying the reasoning similar to that presented above, we can formulate the following formula for the moment of this reaction:

$$M_{zslam} = - \frac{\Delta i_z \omega_{zboat}}{\Delta t} \quad (19)$$

where:

- M_{zslam} – moment of reaction caused by slamming,
- Δi_z – increment of the moment of inertia of the added mass,
- ω_{zboat} – angular velocity of the boat (module),
- Δt – time step.

The hydrodynamic forces caused by the slamming phenomenon only occur when the boat bumps into water $\Delta m > 0$, as only in this case the effect of collision between the mass of the boat and that of the water, with different initial velocities, takes place. When the boat emerges from water $\Delta m < 0$ we can also observe some sort of hydrodynamic reactions but they are generated by other phenomena.

The added masses of water are calculated using the strip theory.

Wave – theoretical model

In the presented method a linear model of wave was adopted. The wave was modelled as a sum of regular waves,

i.e. independent sequences of elementary waves with given amplitudes, angular frequencies and phase shifts.

The velocity potential for the regular wave in deep water is given by the following equation:

$$\Phi(x, z, t) = \frac{ag}{\omega} e^{kz} \sin[kx - \omega(t - t_0)] \quad (20)$$

where:

- a – wave amplitude,
- ω – angular frequency,
- g – acceleration of gravity,
- k – wave number,
- t – time,
- ωt_0 – phase shift,
- x, y – coordinates of the point at which the velocity potential is calculated.

The dynamic boundary condition on free water surface is:

$$\zeta(x, t) = - \frac{1}{g} \frac{\partial \Phi}{\partial t} \quad (21)$$

From Equation (20) and the dynamic boundary condition (21) we obtain the z -coordinate of the wave profile:

$$\zeta(x, t) = a \cos[kx - \omega(t - t_0)] \quad (22)$$

The phase velocity and the dispersion relation are determined from the kinetic boundary condition on free surface for the vertical coordinate of the circular velocity:

$$\frac{\partial \zeta}{\partial t} = \frac{\partial \Phi}{\partial z} \quad (23)$$

Then the dispersion relation (for deep water) can be derived:

$$\omega^2 = kg \quad (24)$$

The phase velocity of the wave is given by:

$$C = g/\omega \quad (25)$$

The horizontal and vertical velocity component can be calculated by integrating Equation (20) with respect to x and z , respectively:

$$u(x, z, t) = \frac{akg}{\omega} e^{kz} \cos[kx - \omega(t - t_0)] \quad (26)$$

$$w(x, z, t) = \frac{akg}{\omega} e^{kz} \sin[kx - \omega(t - t_0)] \quad (27)$$

The hydrodynamic pressure is calculated from the Bernoulli equation:

$$- \frac{\partial \Phi}{\partial t} + \frac{p}{\rho} + gz = 0 \quad (28)$$

after placing into it the velocity potential formula given by Equation (20). Then we get:

$$p(x, y, z) = \rho a g e^{kx} \cos[kx - \omega(t - t_0)] \quad (29)$$

Equation (20) can be modified in order to model the wave moving in an arbitrary direction:

$$\Phi(x, y, z, t) = \sum_{i=0}^n a_i \frac{g}{\omega_i} e^{k_i z} \sin[k_i (e_x x + e_y y) - \omega_i (t - t_{0,i})] \quad (30)$$

where:

- i – wave component index
- e_x, e_y – unit vector components which indicate the wave direction (in the present model the components e_x, e_y are the same for angular frequencies).

PRELIMINARY RESULTS OF TEST CALCULATIONS

Data for calculations

Figure 5 below shows a scheme of the modelled system.

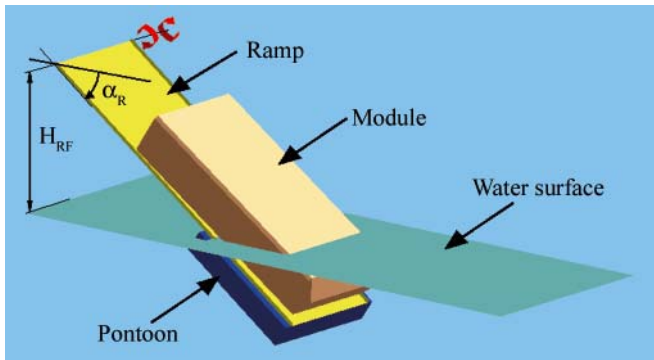

Fig. 5. The system: ramp, module, pontoon and water

Pontoon:

Length	L	m	6.70
Breadth	B	m	6.50
Height	H	m	1.20
Total volume	V	m ³	52.26
Mass	M _p	kg	8000
Moment of inertia around x ₀ -axis	I _{xx0}	kg m ²	29000
Moment of inertia around y ₀ -axis	I _{yy0}	kg m ²	31000
Moment of inertia around z ₀ -axis	I _{zz0}	kg m ²	58000

It was assumed that the mass centre is equivalent with the geometry centre.

The moments of inertia I_{xx0}, I_{yy0} and I_{zz0} were calculated using the formulas:

$$I_{xx0} = \frac{1}{12} M_p (B^2 + H^2) \quad (31)$$

$$I_{yy0} = \frac{1}{12} M_p (L^2 + H^2) \quad (32)$$

$$I_{zz0} = \frac{1}{12} M_p (L^2 + B^2) \quad (33)$$

Ramp (without a pontoon):

Length	L	m	18.30
Breadth	B	m	5.80
Mass	M _R	kg	22000
Moment of inertia around x ₀ -axis	I _{xx0}	kg m ²	62000
Moment of inertia around y ₀ -axis	I _{yy0}	kg m ²	614000
Moment of inertia around z ₀ -axis	I _{zz0}	kg m ²	676000
Maximum angle (from horizontal position)	α _R	deg	36

Module:

Length	L	m	6.30
Breadth	B	m	5.65
Height	H	m	2.50
Draught	T	m	0.60
Mass	M _M	kg	43626
Longitudinal coordinate of mass centre	x _{G0}	m	6.30
Vertical coordinate of mass centre	z _{G0}	m	1.09
Moment of inertia around x ₀ -axis	I _{xx0}	kg m ²	125000
Moment of inertia around y ₀ -axis	I _{yy0}	kg m ²	334000
Moment of inertia around z ₀ -axis	I _{zz0}	kg m ²	334000

where: I_{xx0}, I_{yy0}, I_{zz0} were calculated using the formulas [7]:

$$I_{xx0} = (0.3B)^2 M_M \quad (34)$$

$$I_{yy0} = I_{zz0} = (0.225L)^2 M_M \quad (35)$$

Sample results of calculations of launching in still sea

Scenario no 1

Height of ramp fixing	H _{RF}	m	7.0
Ramp angle at t=0	α _R	deg	26.0
Wave height	H _W	m	0.0
Wave period	T _W	s	-
Wave phase shift	t _{0W}	s	-

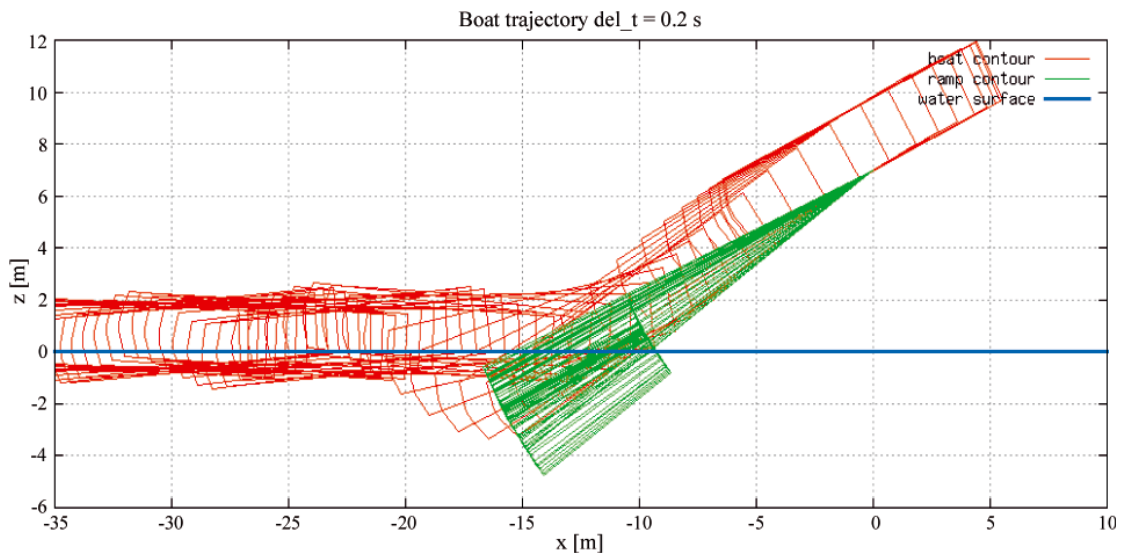

Fig. 6. Module and ramp contours in time, Δt = 0.2 s

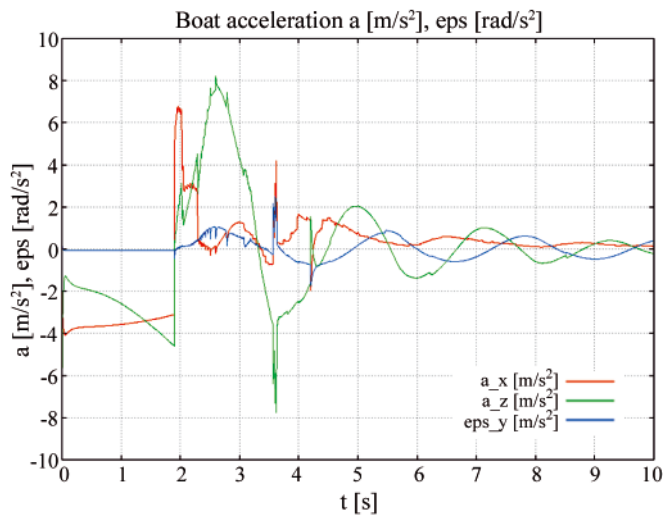

Fig. 7. Module accelerations: horizontal a_x , vertical a_z and angular ϵ_y

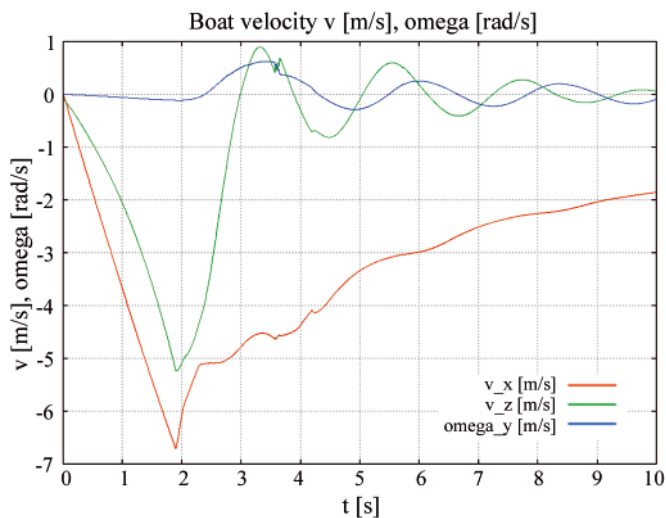

Fig. 8. Module velocity: horizontal v_x , vertical v_z and angular ω_y

CONCLUSIONS

The instantaneous positions of the outlines of the ramp and the module sliding from the ship on still water shown in Fig. 6 look very reliably. Also the time-histories of changes of basic velocity and acceleration components of the mass centre of the launched module shown in Fig. 7 and Fig. 8 are consistent with the experience and expectations of the authors, which testifies to the correctness of the developed model and numerical code.

The developed method also makes it possible to perform numerical simulations for various scenarios of sea conditions. The obtained results of these simulations will be presented and discussed in a separate publication.

BIBLIOGRAPHY

1. Dymarski Cz., Łubiński P., Dymarski P.: *Ramp and chain-lift-launched lifeboats - radical concepts for evacuating cruise ships*. Naval Architect. - October 2006
2. Dymarski Cz., Łubiński P., Vredeveldt A.: *Stern Module - a novel concept for evacuating cruise ships*. Naval Architect. - October 2006
3. Dymarski C.: *An integrated hydraulic drive system of a novel device for launching lifeboats from large passenger ship*. Polish Maritime Research 1 (72) 2012, Vol. 19
4. Deliverable 5.2 – Novel Global Concepts for LSA Systems. SAFECRAFTS – WP5 – D5.2
5. „Principles of Naval Architecture Second Revision, vol. III. Motion in Waves and Controllability”. SNAME 1989
6. von Karman Th.: *The Impact on Seaplane Loads During Landing*. NACA Technical Notes, Washington 1929
7. Kruszewski J., Ostachowicz W., Wittbrot E.: *General mechanics* (in Polish). Gdansk University of Technology, Gdansk 1993
8. Lloyd A.R.J.M.: *Seakeeping: Ship Behaviour in Rough Weather*. Ellis Horwood Limited, New York-Chichester-Brisbane-Toronto 1989
9. Techet A.: *Hydrodynamics*. <http://web.mit.edu/ahtechet/www/teaching.htm>, 2005
10. Brennen C.E.: *A Review of Added Mass and Fluid Inertial Forces*. Naval Civil Engineering Laboratory, Port Hueneme, California 1982
11. Pecot F., Bordier L.: *Multi-body mechanical time domain simulation of the SPSC module behaviour during its launching on the ramp system from the abandoned vessel*. SAFECRAFTS-WP2-1-2_SPSC_ADAMS, SIREHNA 29/09/08
12. Druet C.: *Dynamics of a stratified ocean* (in Polish). Polish Scientific Publishers PWN, Warsaw 1994.

CONTACT WITH THE AUTHORS

Paweł Dymarski, Ph. D.,
 Prof. Czesław Dymarski,
 Faculty of Ocean Engineering
 and Ship Technology,
 Gdańsk University of Technology
 Narutowicza 11/12
 80-233 Gdańsk, POLAND
 e-mail: cpdymars@pg.gda.pl